

XPT IGBT

tentative

$$V_{CES} = 1200V$$

$$I_{C25} = 61A$$

$$V_{CE(sat)} = 1.8V$$

ISOPLUS™ Surface Mount Power Device
 Boost Topology
 XPT IGBT

Part number

IXA40RG1200DHGLB



Backside: isolated

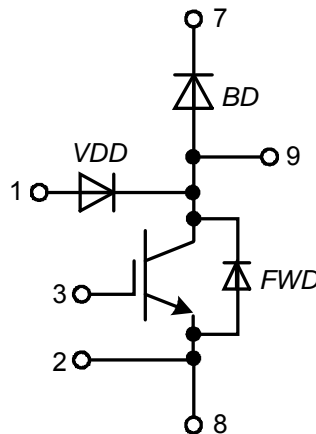
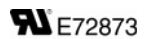

Features / Advantages:

- XPT IGBT
 - low saturation voltage
 - positive temperature coefficient for easy paralleling
 - fast switching
 - short tail current for optimized performance in resonant circuits
- Sonic™ diode
 - fast reverse recovery
 - low operating forward voltage
 - low leakage current
 - low temperature dependency of reverse recovery
- Vcesat detection diode (VDD)
 - integrated into package
 - very fast diode

Applications:

- AC drives
 - brake chopper
- PFC
 - boost chopper
- Switched reluctance drives

Package: SMPD

- Industry convenient outline
- RoHS compliant
- Epoxy meets UL 94V-0
- Soldering pins for PCB mounting
- Backside: DCB ceramic
- Reduced weight
- Advanced power cycling
- Isolation Voltage: 3000 V~

Free Wheeling Diode FWD				Ratings			
Symbol	Definition	Conditions	min.	typ.	max.	Unit	
V_{RSM}	max. non-repetitive reverse blocking voltage	$T_{VJ} = 25^{\circ}\text{C}$			1200	V	
V_{RRM}	max. repetitive reverse blocking voltage	$T_{VJ} = 25^{\circ}\text{C}$			1200	V	
I_R	reverse current, drain current	$V_R = 1200\text{ V}$	$T_{VJ} = 25^{\circ}\text{C}$		30	μA	
		$V_R = 1200\text{ V}$	$T_{VJ} = 125^{\circ}\text{C}$		0.5	mA	
V_F	forward voltage drop	$I_F = 30\text{ A}$	$T_{VJ} = 25^{\circ}\text{C}$		2.20	V	
							V
		$I_F = 60\text{ A}$	$T_{VJ} = 25^{\circ}\text{C}$		2.20	V	
			$T_{VJ} = 125^{\circ}\text{C}$				V
I_{FAV}	average forward current	$T_C = 80^{\circ}\text{C}$ rectangular $d = 0.5$	$T_{VJ} = 150^{\circ}\text{C}$		25	A	
V_{FO}	threshold voltage	} for power loss calculation only	$T_{VJ} = 150^{\circ}\text{C}$		1.26	V	
r_F	slope resistance				28	m Ω	
R_{thJC}	thermal resistance junction to case				1	K/W	
R_{thCH}	thermal resistance case to heatsink			0.30		K/W	
P_{tot}	total power dissipation		$T_C = 25^{\circ}\text{C}$		125	W	
I_{FSM}	max. forward surge current	$t = 10\text{ ms}; (50\text{ Hz}), \text{ sine}; V_R = 0\text{ V}$	$T_{VJ} = 45^{\circ}\text{C}$		200	A	
C_J	junction capacitance	$V_R = 400\text{ V}$ $f = 1\text{ MHz}$	$T_{VJ} = 25^{\circ}\text{C}$		13	pF	

VCEsat Detection Diode VDD				Ratings			
Symbol	Definition	Conditions	min.	typ.	max.	Unit	
V_{RRM}	max. repetitive reverse blocking voltage	$T_{VJ} = 25^{\circ}\text{C}$			1200	V	
I_R	reverse current, drain current	$V_{R/D} = 1200\text{ V}$	$T_{VJ} = 25^{\circ}\text{C}$		2	μA	
		$V_{R/D} = 1200\text{ V}$	$T_{VJ} = 125^{\circ}\text{C}$		0.03	mA	
V_F	forward voltage drop	$I_F = 1\text{ A}$	$T_{VJ} = 25^{\circ}\text{C}$		2.20	V	
			$T_{VJ} = 125^{\circ}\text{C}$		1.80	V	
V_{FO}	threshold voltage	} for power loss calculation only	$T_{VJ} = 150^{\circ}\text{C}$		1.30	V	
r_F	slope resistance				390	m Ω	
C_J	junction capacitance	$V_R = 400\text{ V}; f = 1\text{ MHz}$	$T_{VJ} = 25^{\circ}\text{C}$		tbd	pF	
I_{RM}	max. reverse recovery current	} $V_R = 100\text{ V}; I_F = 1\text{ A}$ $-di/dt = 100\text{ A}/\mu\text{s}$	$T_{VJ} = 25^{\circ}\text{C}$		2.3	A	
t_{rr}	reverse recovery time		$T_{VJ} = 125^{\circ}\text{C}$		tbd	A	
			$T_{VJ} = 25^{\circ}\text{C}$		40	ns	
			$T_{VJ} = 125^{\circ}\text{C}$		tbd	ns	

Boost IGBT				Ratings			
Symbol	Definition	Conditions	min.	typ.	max.	Unit	
V_{CES}	collector emitter voltage	$T_{VJ} = 25^{\circ}\text{C}$			1200	V	
V_{GES}	max. DC gate voltage				± 20	V	
V_{GEM}	max. transient collector gate voltage				± 30	V	
I_{C25}	collector current	$T_C = 25^{\circ}\text{C}$			61	A	
I_{C80}		$T_C = 80^{\circ}\text{C}$			43	A	
P_{tot}	total power dissipation	$T_C = 25^{\circ}\text{C}$			215	W	
$V_{CE(sat)}$	collector emitter saturation voltage	$I_C = 35\text{ A}; V_{GE} = 15\text{ V}$			1.8	V	
					2.1	V	
$V_{GE(th)}$	gate emitter threshold voltage	$I_C = 1.5\text{ mA}; V_{CE} = V_{CE}$	5.4	5.9	6.5	V	
I_{CES}	collector emitter leakage current	$V_{CE} = V_{CES}; V_{GE} = 0\text{ V}$			0.1	mA	
					0.1	mA	
I_{GES}	gate emitter leakage current	$V_{GE} = \pm 20\text{ V}$			500	nA	
$Q_{G(on)}$	total gate charge	$V_{CE} = 600\text{ V}; V_{GE} = 15\text{ V}; I_C = 35\text{ A}$		107		nC	
$t_{d(on)}$	turn-on delay time	inductive load $V_{CE} = 600\text{ V}; I_C = 35\text{ A}$ $V_{GE} = \pm 15\text{ V}; R_G = 27\ \Omega$		70		ns	
t_r	current rise time		$T_{VJ} = 125^{\circ}\text{C}$	40		ns	
$t_{d(off)}$	turn-off delay time		250		ns		
t_f	current fall time		100		ns		
E_{on}	turn-on energy per pulse		3.8		mJ		
E_{off}	turn-off energy per pulse		4.1		mJ		
RBSOA	reverse bias safe operating area	$V_{GE} = \pm 15\text{ V}; R_G = 27\ \Omega$					
I_{CM}		$V_{CEmax} = 1200\text{ V}$			105	A	
SCSOA	short circuit safe operating area	$V_{CEmax} = 1200\text{ V}$					
t_{sc}	short circuit duration	$V_{CE} = 900\text{ V}; V_{GE} = \pm 15\text{ V}$			10	μs	
I_{sc}	short circuit current	$R_G = 27\ \Omega; \text{non-repetitive}$		140		A	
R_{thJC}	thermal resistance junction to case				0.58	K/W	
R_{thCH}	thermal resistance case to heatsink				0.17	K/W	
Boost Diode BD							
V_{RRM}	max. repetitive reverse voltage	$T_{VJ} = 25^{\circ}\text{C}$			1200	V	
I_{F25}	forward current	$T_C = 25^{\circ}\text{C}$			48	A	
I_{F80}		$T_C = 80^{\circ}\text{C}$			32	A	
V_F	forward voltage	$I_F = 30\text{ A}$			2.20	V	
					1.90	V	
I_R	reverse current	$V_R = V_{RRM}$			0.03	mA	
					0.15	mA	
Q_{rr}	reverse recovery charge	$V_R = 600\text{ V}$ $-di_F/dt = 600\text{ A}/\mu\text{s}$ $I_F = 30\text{ A}; V_{GE} = 0\text{ V}$		3.5		μC	
I_{RM}	max. reverse recovery current		$T_{VJ} = 125^{\circ}\text{C}$	30		A	
t_{rr}	reverse recovery time		350		ns		
E_{rec}	reverse recovery energy		0.9		mJ		
R_{thJC}	thermal resistance junction to case				1	K/W	
R_{thCH}	thermal resistance case to heatsink				0.3	K/W	

tentative

Package SMPD		Ratings				
Symbol	Definition	Conditions	min.	typ.	max.	Unit
I_{RMS}	RMS current	per terminal			100	A
T_{stg}	storage temperature		-55		150	°C
T_{vj}	virtual junction temperature		-55		150	°C
Weight				8.5		g
F_C	mounting force with clip		40		130	N
V_{ISOL}	isolation voltage	t = 1 second	3000			V
		t = 1 minute	2500			V
$d_{Spp/App}$	creepage distance on surface striking distance through air	terminal to terminal	1.6			mm
		terminal to backside	4.0			mm

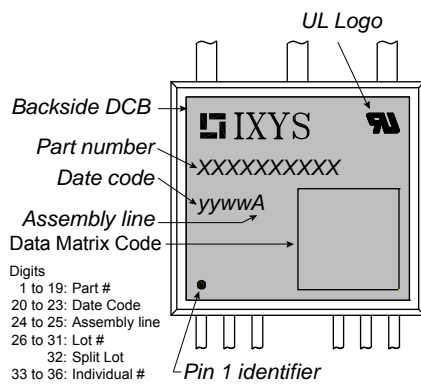

Part number

- I = IGBT
- X = XPT IGBT
- A = Gen 1 / std
- 40 = Current Rating [A]
- RG = boost configuration
- 1200 = Reverse Voltage [V]
- D = IGBT
- H = XPT IGBT
- G = Gen 1 / std
- LB = SMPD-B

Ordering	Part Number	Marking on Product	Delivery Mode	Quantity	Code No.
Standard	IXA40RG1200DHGLB	IXA40RG1200DHGLB	Blister	45	512363
Alternative	IXA40RG1200DHGLB-TRR	IXA40RG1200DHGLB	Tape & Reel	200	511661

Similar Part	Package	Voltage class
IXA20RG1200DHGLB	SMPD-B	1200
IXA30RG1200DHGLB	SMPD-B	1200

Outlines SMPD

A (8 : 1)



Boost IGBT

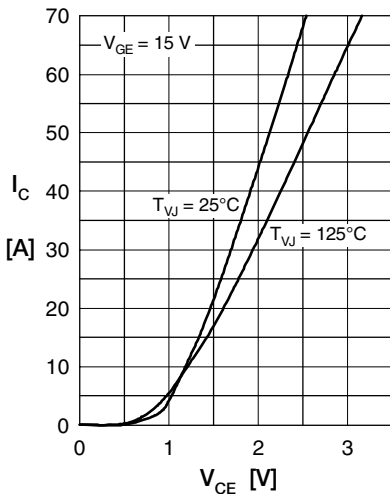

Fig. 1 Typ. output characteristics

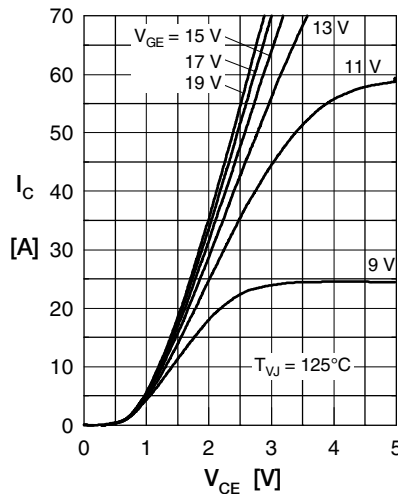

Fig. 2 Typ. output characteristics

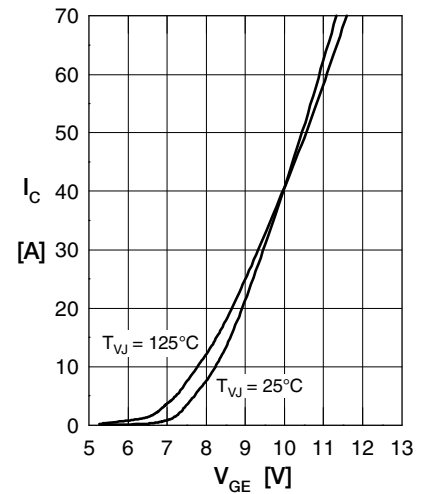

Fig. 3 Typ. transfer characteristics

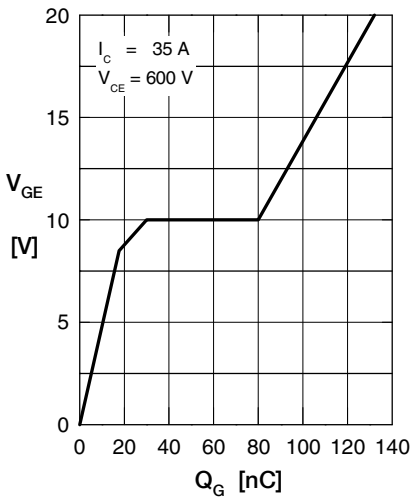

Fig. 4 Typ. turn-on gate charge

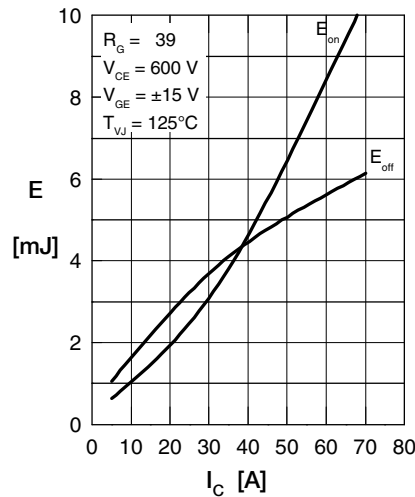

Fig. 5 Typ. switching energy versus collector current

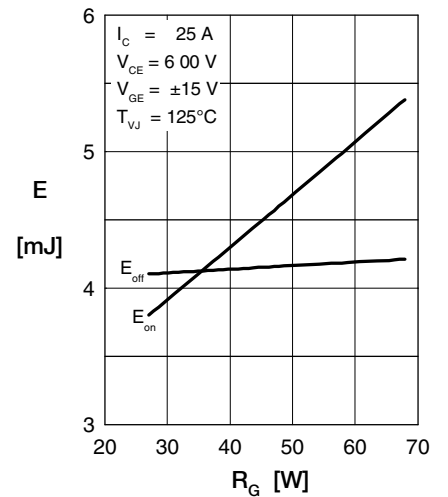

Fig. 6 Typ. switching energy versus gate resistance

Fig. 7 Typ. transient thermal impedance junction to case

Boost Diode BD

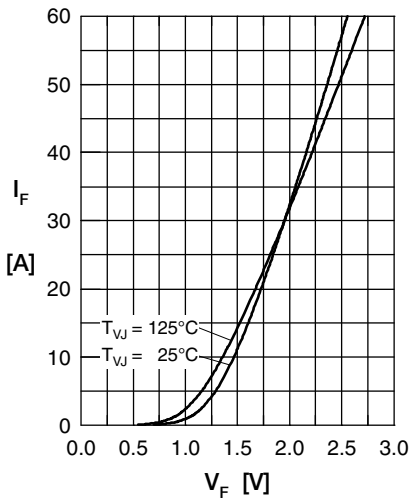

Fig. 1 Typ. Forward current versus V_F

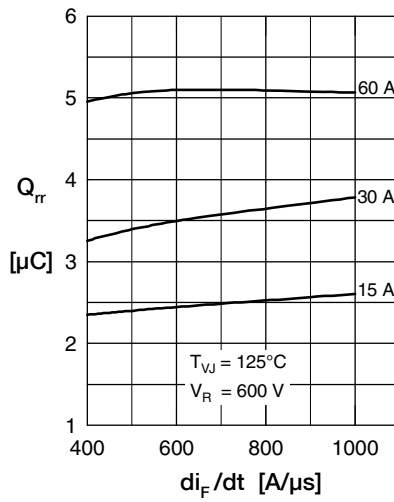

Fig. 2 Typ. reverse recov. charge Q_{rr} versus di/dt

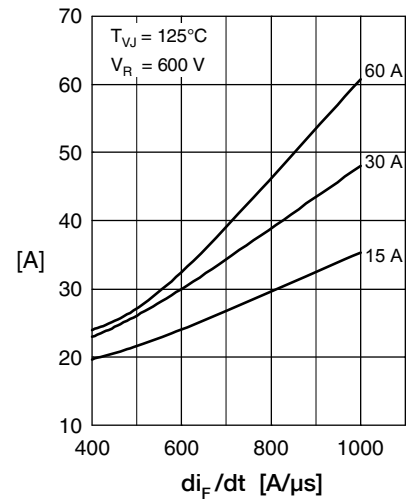

Fig. 3 Typ. peak reverse current I_{RM} versus di/dt

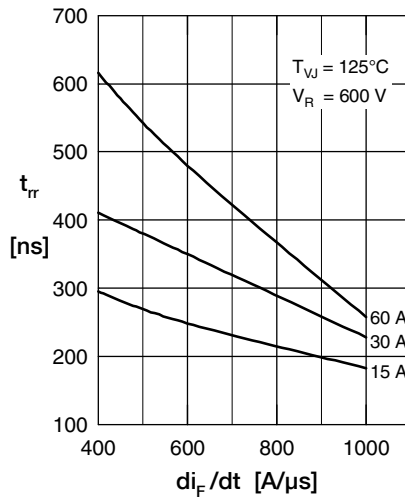

Fig. 4 Dynamic parameters Q_{rr} , I_{RM} versus di/dt

Fig. 5 Typ. recovery time t_{rr} versus di/dt

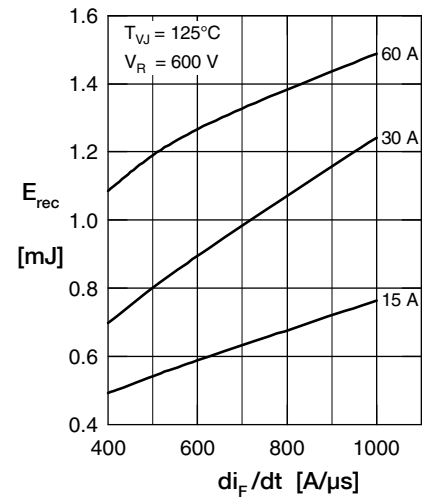

Fig. 6 Typ. recovery energy E_{rec} versus di/dt

Fig. 7 Typ. transient thermal impedance junction to case