

Optocoupler, Phototransistor Output (Dual, Quad Channel)

Dual Channel

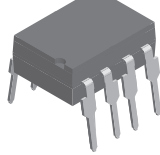

Quad Channel

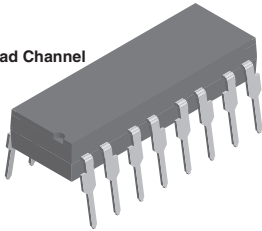

i179012-1

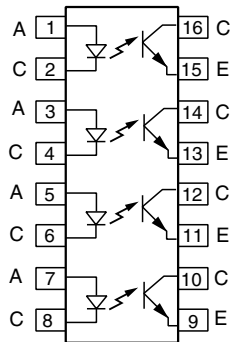
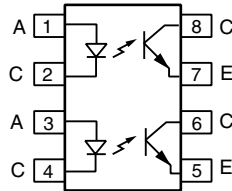

i179052-2



FEATURES

- Identical channel to channel footprint
- Dual and quad packages feature:
 - Reduced board space
 - Lower pin and parts count
 - Better channel to channel CTR match
 - Improved common mode rejection
- Isolation test voltage from double molded package, 5300 V_{RMS}
- Compliant to RoHS Directive 2002/95/EC and in accordance to WEEE 2002/96/EC

RoHS
COMPLIANT

AGENCY APPROVALS

- UL1577, file no. E52744 system code H, double protection
- CSA 93751
- BSI IEC 60950; IEC 60065
- DIN EN 60747-5-2 (VDE0884)/DIN EN 60747-5-5 pending, available with option 1

DESCRIPTION

The ILD615, ILQ615 are multi-channel phototransistor optocouplers that use GaAs IRLED emitters and high gain NPN phototransistors. These devices are constructed using over/under leadframe optical coupling and double molded insulation technology resulting a withstand test voltage of 7500 V_{ACPEAK} and a working voltage of 1700 V_{RMS}.

The binned min./max. and linear CTR characteristics make these devices well suited for DC or AC voltage detection. Eliminating the phototransistor base connection provides added electrical noise immunity from the transients found in many industrial control environments.

Because of guaranteed maximum non-saturated and saturated switching characteristics, the ILD615, ILQ615 can be used in medium speed data I/O and control systems. The binned min./max. CTR specification allow easy worst case interface calculations for both level detection and switching applications. Interfacing with a CMOS logic is enhanced by the guaranteed CTR at I_F = 1 mA.

ILD615, ILQ615



Vishay Semiconductors Optocoupler, Phototransistor Output
(Dual, Quad Channel)

ORDERING INFORMATION

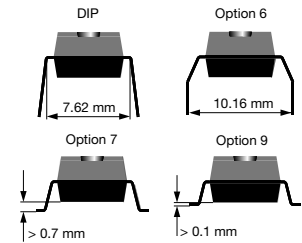
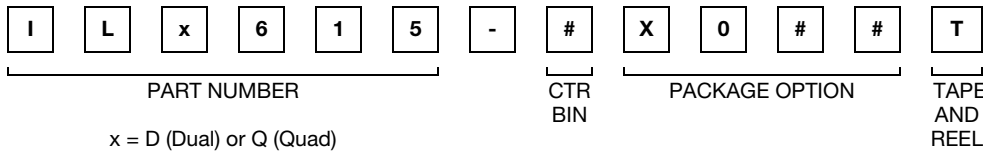

| AGENCY CERTIFIED/PACKAGE | DUAL CHANNEL | | | | QUAD CHANNEL | | | |
|---------------------------|---------------|------------------------------|------------------------------|------------------------------|--------------|--------------|------------------------------|------------------------------|
| | CTR (%) | | | | | | | |
| | 10 mA | | | | | | | |
| UL, CSA, BSI, VDE | 40 to 80 | 63 to 125 | 100 to 200 | 160 to 320 | 40 to 80 | 63 to 125 | 100 to 200 | 160 to 320 |
| DIP-8 | ILD615-1 | ILD615-2 | ILD615-3 | ILD615-4 | - | - | - | - |
| DIP-8, 400 mil, option 6 | - | - | - | ILD615-4X006 | - | - | - | - |
| SMD-8, option 7 | ILD615-1X007T | - | - | - | - | - | - | - |
| SMD-8, option 9 | ILD615-1X009 | ILD615-2X009T ⁽¹⁾ | ILD615-3X009T | ILD615-4X009T ⁽¹⁾ | - | - | - | - |
| DIP-16 | - | - | - | - | ILQ615-1 | ILQ615-2 | ILQ615-3 | ILQ615-4 |
| SMD-16, option 7 | - | - | - | - | - | ILQ615-2X007 | ILQ615-3X007T ⁽¹⁾ | ILQ615-4X007 |
| SMD-16, option 9 | - | - | - | - | ILQ615-1X009 | - | ILQ615-3X009T ⁽¹⁾ | ILQ615-4X009T ⁽¹⁾ |
| VDE | 40 to 80 | 63 to 125 | 100 to 200 | 160 to 320 | 40 to 80 | 63 to 125 | 100 to 200 | 160 to 320 |
| DIP-8 | - | ILD615-2X001 | - | ILD615-4X001 | - | - | - | - |
| DIP-8, 400 mil, option 6 | - | ILD615-2X016 | ILD615-3X016 | ILD615-4X016 | - | - | - | - |
| SMD-8, option 7 | - | - | ILD615-3X017T ⁽¹⁾ | - | - | - | - | - |
| DIP-16 | - | - | - | - | - | - | ILQ615-3X001 | ILQ615-4X001 |
| DIP-16, 400 mil, option 6 | - | - | - | - | - | - | ILQ615-3X016 | - |
| SMD-16, option 7 | - | - | - | - | - | ILQ615-2X017 | - | - |

Notes

- Also available in tubes; do not add T to end.
- Additional options may be possible, please contact sales office.

ABSOLUTE MAXIMUM RATINGS (T_{amb} = 25 °C, unless otherwise specified)

| PARAMETER | TEST CONDITION | SYMBOL | VALUE | UNIT |
|-------------------------------------|----------------|-------------------|-------|-------|
| INPUT | | | | |
| Reverse voltage | | V _R | 6 | V |
| Forward current | | I _F | 60 | mA |
| Surge current | | I _{FSM} | 1.5 | A |
| Power dissipation | | P _{diss} | 100 | mW |
| Derate linearly from 25 °C | | | 1.33 | mW/°C |
| OUTPUT | | | | |
| Collector emitter breakdown voltage | | BV _{CEO} | 70 | V |
| Emitter collector breakdown voltage | | BV _{ECO} | 7 | V |
| Collector current | | I _C | 50 | mA |
| | t < 1 ms | I _C | 100 | mA |
| Power dissipation | | P _{diss} | 150 | mW |
| Derate linearly from 25 °C | | | 2 | mW/°C |

**Optocoupler, Phototransistor Output Vishay Semiconductors
(Dual, Quad Channel)**

| ABSOLUTE MAXIMUM RATINGS ($T_{amb} = 25\text{ }^{\circ}\text{C}$, unless otherwise specified) | | | | |
|--|--|------------|----------------|------------------------|
| PARAMETER | TEST CONDITION | SYMBOL | VALUE | UNIT |
| COUPLER | | | | |
| Storage temperature | | T_{stg} | - 55 to + 150 | $^{\circ}\text{C}$ |
| Operating temperature | | T_{amb} | - 55 to + 100 | $^{\circ}\text{C}$ |
| Junction temperature | | T_j | 100 | $^{\circ}\text{C}$ |
| Soldering temperature ⁽¹⁾ | 2 mm distance from case bottom | T_{sld} | 260 | $^{\circ}\text{C}$ |
| Package power dissipation ILD615 | | | 400 | mW |
| Derate linearly from 25 $^{\circ}\text{C}$ | | | 5.33 | mW/ $^{\circ}\text{C}$ |
| Package power dissipation ILQ615 | | | 500 | mW |
| Derate linearly from 25 $^{\circ}\text{C}$ | | | 6.67 | mW/ $^{\circ}\text{C}$ |
| Isolation test voltage | $t = 1\text{ s}$ | V_{ISO} | 5300 | V_{RMS} |
| Isolation voltage | | V_{IORM} | 890 | V_P |
| Total power dissipation | | P_{tot} | 250 | mW |
| Creepage distance | | | ≥ 7 | mm |
| Clearance distance | | | ≥ 7 | mm |
| Isolation resistance | $V_{IO} = 500\text{ V}, T_{amb} = 25\text{ }^{\circ}\text{C}$ | R_{IO} | $\geq 10^{12}$ | Ω |
| | $V_{IO} = 500\text{ V}, T_{amb} = 100\text{ }^{\circ}\text{C}$ | R_{IO} | $\geq 10^{11}$ | Ω |

Notes

- Stresses in excess of the absolute maximum ratings can cause permanent damage to the device. Functional operation of the device is not implied at these or any other conditions in excess of those given in the operational sections of this document. Exposure to absolute maximum ratings for extended periods of the time can adversely affect reliability.

⁽¹⁾ Refer to reflow profile for soldering conditions for surface mounted devices (SMD). Refer to wave profile for soldering conditions for through hole devices (DIP).

| ELECTRICAL CHARACTERISTICS ($T_{amb} = 25\text{ }^{\circ}\text{C}$, unless otherwise specified) | | | | | | |
|--|---|------------------------------------|-----------|-----------|--------|---------------|
| PARAMETER | TEST CONDITION | SYMBOL | MIN. | TYP. | MAX. | UNIT |
| INPUT | | | | | | |
| Forward voltage | $I_F = 10\text{ mA}$ | V_F | 1 | 1.15 | 1.3 | V |
| Breakdown voltage | $I_R = 10\text{ }\mu\text{A}$ | V_{BR} | 6 | 30 | | V |
| Reverse current | $V_R = 6\text{ V}$ | I_R | | 0.01 | 10 | μA |
| Capacitance | $V_R = 0\text{ V}, f = 1\text{ MHz}$ | C_O | | 25 | | pF |
| Thermal resistance, junction to lead | | R_{THJL} | | 750 | | K/W |
| OUTPUT | | | | | | |
| Collector emitter capacitance | $V_{CE} = 5\text{ V}, f = 1\text{ MHz}$ | C_{CE} | | 6.8 | | pF |
| Collector emitter leakage current, -1, -2 | $V_{CE} = 10\text{ V}$ | I_{CEO} | | 2 | 50 | nA |
| Collector emitter leakage current, -3, -4 | $V_{CE} = 10\text{ V}$ | I_{CEO} | | 5 | 100 | nA |
| Collector emitter breakdown voltage | $I_{CE} = 0.5\text{ mA}$ | BV_{CEO} | 70 | | | V |
| Emitter collector breakdown voltage | $I_E = 0.1\text{ mA}$ | BV_{ECO} | 7 | | | V |
| Thermal resistance, junction to lead | | R_{THJL} | | 500 | | K/W |
| PACKAGE TRANSFER CHARACTERISTICS | | | | | | |
| Channel/channel CTR match | $I_F = 10\text{ mA}, V_{CE} = 5\text{ V}$ | CTR _X /CTR _Y | 1 to 1 | | 2 to 1 | |
| COUPLER | | | | | | |
| Capacitance (input to output) | $V_{IO} = 0\text{ V}, f = 1\text{ MHz}$ | C_{IO} | | 0.8 | | pF |
| Insulation resistance | $V_{IO} = 500\text{ V}, T_A = 25\text{ }^{\circ}\text{C}$ | R_S | 10^{12} | 10^{14} | | Ω |
| Channel to channel isolation | | | 500 | | | VAC |

Note

- Minimum and maximum values are tested requirements. Typical values are characteristics of the device and are the result of engineering evaluations. Typical values are for information only and are not part of the testing requirements.

| CURRENT TRANSFER RATIO ($T_{amb} = 25\text{ }^{\circ}\text{C}$, unless otherwise specified) | | | | | | | |
|---|--|----------|----------------------|------|------|------|------|
| PARAMETER | TEST CONDITION | PART | SYMBOL | MIN. | TYP. | MAX. | UNIT |
| Current transfer ratio (collector emitter saturated) | $I_F = 10\text{ mA}$, $V_{CE} = 0.4\text{ V}$ | ILD615-1 | CTR _{CEsat} | | 25 | | % |
| | | ILQ615-1 | | | | | |
| | | ILD615-2 | CTR _{CEsat} | | | | |
| | | ILQ615-2 | | | | | |
| | | ILD615-3 | CTR _{CEsat} | | | | |
| | | ILQ615-3 | | | | | |
| | | ILD615-4 | CTR _{CEsat} | | | | |
| | | ILQ615-4 | | | | | |
| Current transfer ratio (collector emitter) | $I_F = 1\text{ mA}$, $V_{CE} = 5\text{ V}$ | ILD615-1 | CTR _{CE} | 13 | 30 | | % |
| | | ILQ615-1 | | | | | |
| | | ILD615-2 | CTR _{CE} | | | | |
| | | ILQ615-2 | | | | | |
| | | ILD615-3 | CTR _{CE} | | | | |
| | | ILQ615-3 | | | | | |
| | | ILD615-4 | CTR _{CE} | | | | |
| | | ILQ615-4 | | | | | |
| | $I_F = 10\text{ mA}$, $V_{CE} = 5\text{ V}$ | ILD615-1 | CTR _{CE} | 40 | 60 | 80 | % |
| | | ILQ615-1 | | | | | |
| | | ILD615-2 | CTR _{CE} | | | | |
| | | ILQ615-2 | | | | | |
| | | ILD615-3 | CTR _{CE} | | | | |
| | | ILQ615-3 | | | | | |
| ILD615-4 | CTR _{CE} | | | | | | |
| ILQ615-4 | | | | | | | |

| SAFETY AND INSULATION RATED PARAMETERS | | | | | | |
|---|---|------------|-----------|------|------|--------------------|
| PARAMETER | TEST CONDITION | SYMBOL | MIN. | TYP. | MAX. | UNIT |
| Partial discharge test voltage - routine test | 100 %, $t_{test} = 1\text{ s}$ | V_{pd} | 1.669 | | | kV |
| Partial discharge test voltage - lot test (sample test) | $t_{Tr} = 60\text{ s}$, $t_{test} = 10\text{ s}$, (see figure 2) | V_{IOTM} | 10 | | | kV |
| | | V_{pd} | 1.424 | | | kV |
| Insulation resistance | $V_{IO} = 500\text{ V}$ | R_{IO} | 10^{12} | | | Ω |
| | $V_{IO} = 500\text{ V}$, $T_{amb} = 100\text{ }^{\circ}\text{C}$ | R_{IO} | 10^{11} | | | Ω |
| | $V_{IO} = 500\text{ V}$, $T_{amb} = 175\text{ }^{\circ}\text{C}$ (construction test only) | R_{IO} | 10^9 | | | Ω |
| Forward current | | I_{SI} | | | 275 | mA |
| Power dissipation | | P_{SO} | | | 400 | mW |
| Rated impulse voltage | | V_{IOTM} | | | 10 | kV |
| Safety temperature | | T_{SI} | | | 175 | $^{\circ}\text{C}$ |

Note

- According to DIN EN 60747-5-2 (see figure 2). This optocoupler is suitable for safe electrical isolation only within the safety ratings. Compliance with the safety ratings shall be ensured by means of suitable protective circuits.

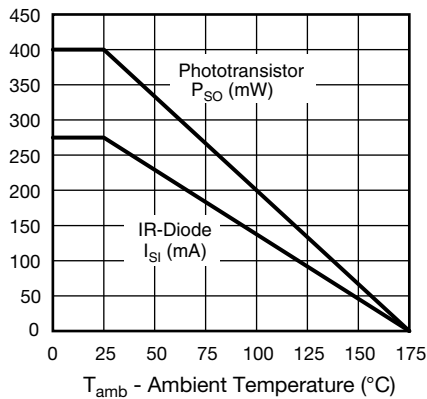
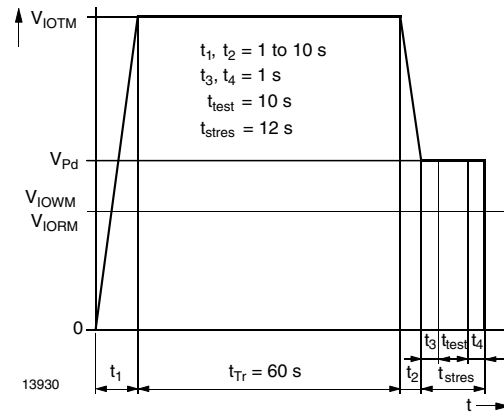

Fig. 1 - Derating Diagram

 Fig. 2 - Test Pulse Diagram for Sample Test according to
 DIN EN 60747-5-2 (VDE0884); IEC60747-5-5

| SWITCHING CHARACTERISTICS ($T_{amb} = 25\text{ }^{\circ}\text{C}$, unless otherwise specified) | | | | | | | |
|---|---|----------|-----------|------|---------------|------|---------------|
| PARAMETER | TEST CONDITION | PART | SYMBOL | MIN. | TYP. | MAX. | UNIT |
| NON-SATURATED | | | | | | | |
| Current | $V_{CC} = 5\text{ V}$, $R_L = 75\text{ }\Omega$, 50 % of V_{PP} | | I_F | | 10 | | mA |
| Turn-on time | $V_{CC} = 5\text{ V}$, $R_L = 75\text{ }\Omega$, 50 % of V_{PP} | | t_{on} | | 3 | | μs |
| Rise time | $V_{CC} = 5\text{ V}$, $R_L = 75\text{ }\Omega$, 50 % of V_{PP} | | t_r | | 2 | | μs |
| Turn-off time | $V_{CC} = 5\text{ V}$, $R_L = 75\text{ }\Omega$, 50 % of V_{PP} | | t_{off} | | 2.3 | | μs |
| Fall time | $V_{CC} = 5\text{ V}$, $R_L = 75\text{ }\Omega$, 50 % of V_{PP} | | t_f | | 2 | | μs |
| Propagation H to L | $V_{CC} = 5\text{ V}$, $R_L = 75\text{ }\Omega$, 50 % of V_{PP} | | t_{PHL} | | 1.1 | | μs |
| Propagation L to H | $V_{CC} = 5\text{ V}$, $R_L = 75\text{ }\Omega$, 50 % of V_{PP} | | t_{PLH} | | 2.5 | | μs |
| SATURATED | | | | | | | |
| Current | $V_{CC} = 5\text{ V}$, $R_L = 1\text{ k}\Omega$, $V_{TH} = 1.5\text{ V}$ | ILD615-1 | I_F | | 20 | | mA |
| | | ILQ615-1 | | | | | |
| | | ILD615-2 | I_F | | 10 | | mA |
| | | ILQ615-2 | | | | | |
| | | ILD615-3 | I_F | | 10 | | mA |
| | | ILQ615-3 | | | | | |
| ILD615-4 | I_F | | 5 | | mA | | |
| ILQ615-4 | | | | | | | |
| Turn-on time | $V_{CC} = 5\text{ V}$, $R_L = 1\text{ k}\Omega$, $V_{TH} = 1.5\text{ V}$ | ILD615-1 | t_{on} | | 3 | | μs |
| | | ILQ615-1 | | | | | |
| | | ILD615-2 | t_{on} | | 4.3 | | μs |
| | | ILQ615-2 | | | | | |
| | | ILD615-3 | t_{on} | | 4.3 | | μs |
| | | ILQ615-3 | | | | | |
| ILD615-4 | t_{on} | | 6 | | μs | | |
| ILQ615-4 | | | | | | | |

ILD615, ILQ615



Vishay Semiconductors Optocoupler, Phototransistor Output
(Dual, Quad Channel)

| SWITCHING CHARACTERISTICS ($T_{amb} = 25\text{ }^{\circ}\text{C}$, unless otherwise specified) | | | | | | | |
|--|---|----------|-----------|------|---------------|------|---------------|
| PARAMETER | TEST CONDITION | PART | SYMBOL | MIN. | TYP. | MAX. | UNIT |
| SATURATED | | | | | | | |
| Rise time | $V_{CC} = 5\text{ V}$, $R_L = 1\text{ k}\Omega$, $V_{TH} = 1.5\text{ V}$ | ILD615-1 | t_r | | 2 | | μs |
| | | ILQ615-1 | | | | | |
| | | ILD615-2 | t_r | | 2.8 | | μs |
| | | ILQ615-2 | | | | | |
| | | ILD615-3 | t_r | | 2.8 | | μs |
| | | ILQ615-3 | | | | | |
| ILD615-4 | t_r | | 4.6 | | μs | | |
| ILQ615-4 | | | | | | | |
| Turn-off time | $V_{CC} = 5\text{ V}$, $R_L = 1\text{ k}\Omega$, $V_{TH} = 1.5\text{ V}$ | ILD615-1 | t_{off} | | 18 | | μs |
| | | ILQ615-1 | | | | | |
| | | ILD615-2 | t_{off} | | 25 | | μs |
| | | ILQ615-2 | | | | | |
| | | ILD615-3 | t_{off} | | 25 | | μs |
| | | ILQ615-3 | | | | | |
| ILD615-4 | t_{off} | | 25 | | μs | | |
| ILQ615-4 | | | | | | | |
| Fall time | $V_{CC} = 5\text{ V}$, $R_L = 1\text{ k}\Omega$, $V_{TH} = 1.5\text{ V}$ | ILD615-1 | t_f | | 11 | | μs |
| | | ILQ615-1 | | | | | |
| | | ILD615-2 | t_f | | 14 | | μs |
| | | ILQ615-2 | | | | | |
| | | ILD615-3 | t_f | | 14 | | μs |
| | | ILQ615-3 | | | | | |
| ILD615-4 | t_f | | 15 | | μs | | |
| ILQ615-4 | | | | | | | |
| Propagation H to L | $V_{CC} = 5\text{ V}$, $R_L = 1\text{ k}\Omega$, $V_{TH} = 1.5\text{ V}$ | ILD615-1 | t_{PHL} | | 1.6 | | μs |
| | | ILQ615-1 | | | | | |
| | | ILD615-2 | t_{PHL} | | 2.6 | | μs |
| | | ILQ615-2 | | | | | |
| | | ILD615-3 | t_{PHL} | | 2.6 | | μs |
| | | ILQ615-3 | | | | | |
| ILD615-4 | t_{PHL} | | 5.4 | | μs | | |
| ILQ615-4 | | | | | | | |
| Propagation L to H | $V_{CC} = 5\text{ V}$, $R_L = 1\text{ k}\Omega$, $V_{TH} = 1.5\text{ V}$ | ILD615-1 | t_{PLH} | | 8.6 | | μs |
| | | ILQ615-1 | | | | | |
| | | ILD615-2 | t_{PLH} | | 7.2 | | μs |
| | | ILQ615-2 | | | | | |
| | | ILD615-3 | t_{PLH} | | 7.2 | | μs |
| | | ILQ615-3 | | | | | |
| ILD615-4 | t_{PLH} | | 7.4 | | μs | | |
| ILQ615-4 | | | | | | | |

| COMMON MODE TRANSIENT IMMUNITY ($T_{amb} = 25\text{ }^{\circ}\text{C}$, unless otherwise specified) | | | | | | | |
|---|---|----------|------|------|------|------------------------|--|
| PARAMETER | TEST CONDITION | SYMBOL | MIN. | TYP. | MAX. | UNIT | |
| Common mode rejection output high | $V_{CM} = 50\text{ V}_{P-P}$, $R_L = 1\text{ k}\Omega$, $I_F = 0\text{ mA}$ | CM_H | | 5000 | | $\text{V}/\mu\text{s}$ | |
| Common mode rejection output low | $V_{CM} = 50\text{ V}_{P-P}$, $R_L = 1\text{ k}\Omega$, $I_F = 0\text{ mA}$ | CM_L | | 5000 | | $\text{V}/\mu\text{s}$ | |
| Common mode coupling capacitance | | C_{CM} | | 0.01 | | pF | |

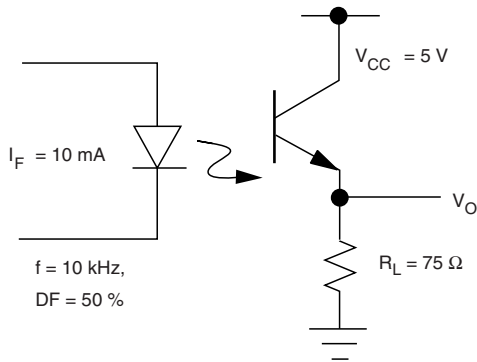
TYPICAL CHARACTERISTICS ($T_{amb} = 25\text{ }^{\circ}\text{C}$, unless otherwise specified)

iild615_01

Fig. 3 - Non-Saturated Switching Timing

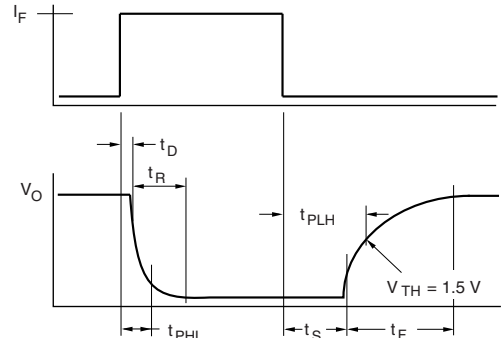

iild615_04

Fig. 6 - Saturated Switching Timing

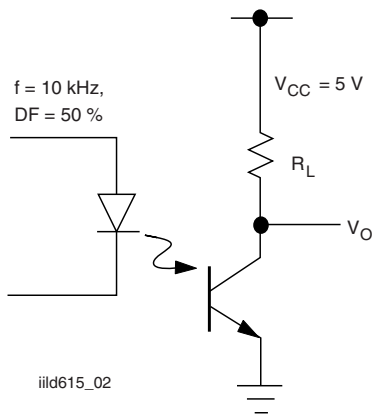

iild615_02

Fig. 4 - Saturated Switching Timing

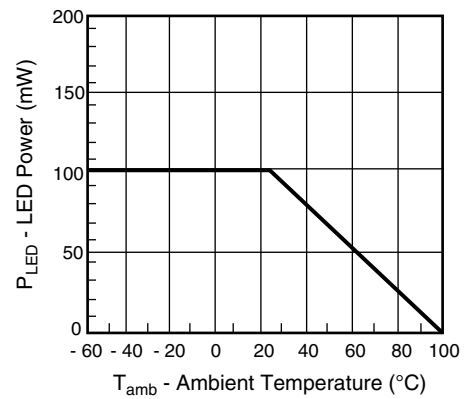
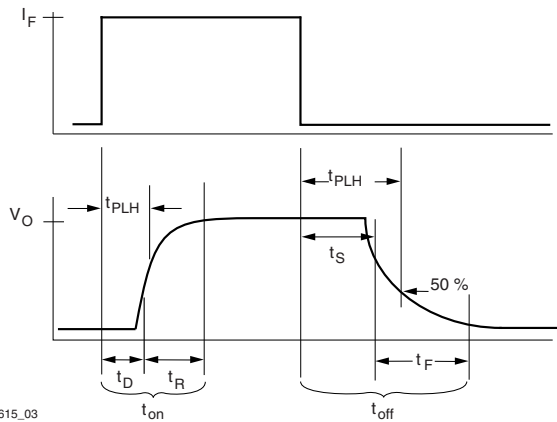
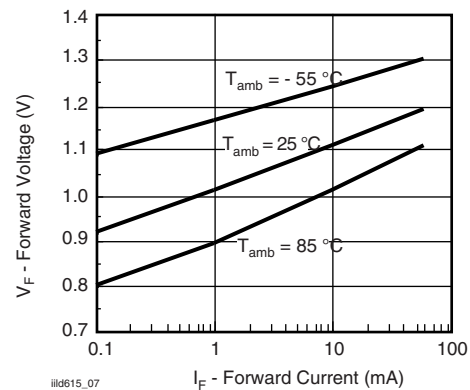

Fig. 7 - Maximum LED Power Dissipation



iild615_03

Fig. 5 - Non-Saturated Switching Timing



iild615_07

Fig. 8 - Forward Voltage vs. Forward Current

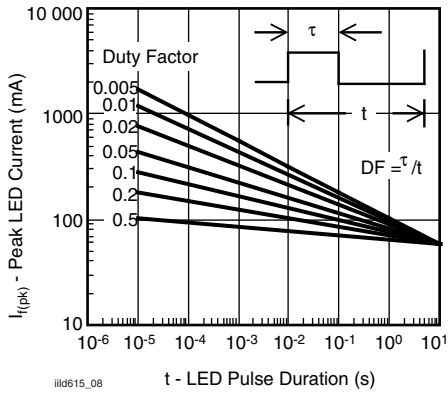

Fig. 9 - Peak LED Current vs. Pulse Duration, τ

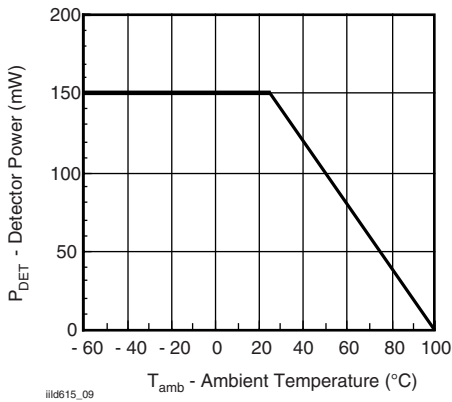

Fig. 10 - Maximum Detector Power Dissipation

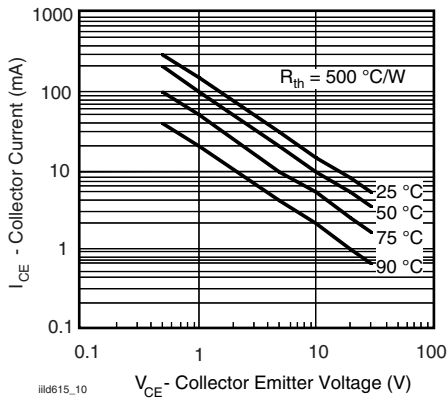

Fig. 11 - Maximum Collector Current vs. Collector Voltage

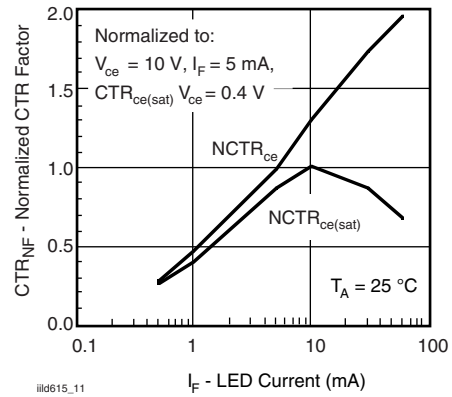

Fig. 12 - Normalization Factor for Non-Saturated and Saturated CTR vs. I_F

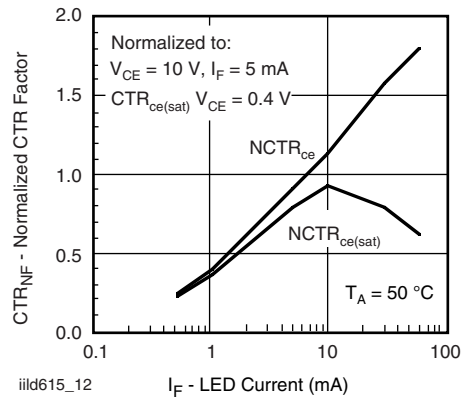

Fig. 13 - Normalization Factor for Non-Saturated and Saturated CTR vs. I_F

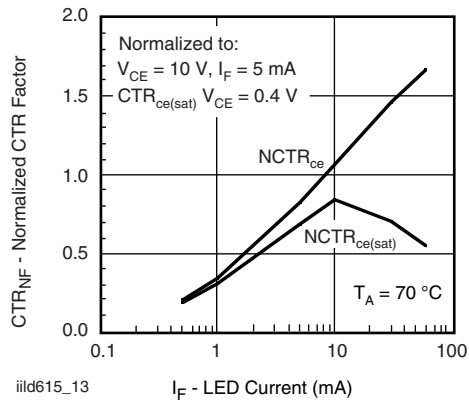

Fig. 14 - Normalization Factor for Non-Saturated and Saturated CTR vs. I_F

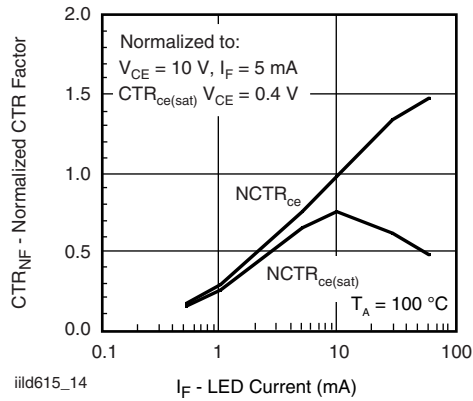

Fig. 15 - Normalization Factor for Non-Saturated and Saturated CTR vs. I_F

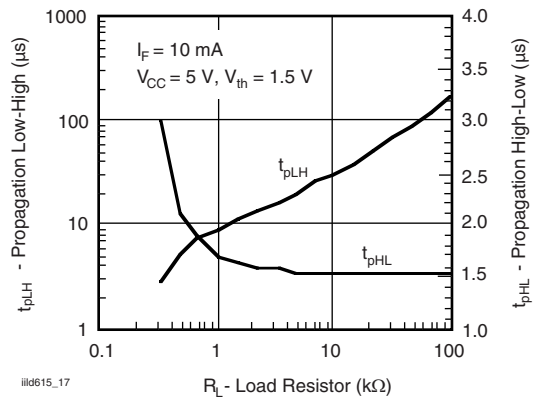

Fig. 18 - -1, Propagation Delay vs. Collector Load Resistor

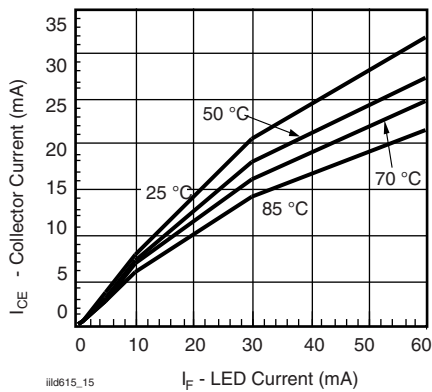

Fig. 16 - Collector Emitter Current vs. Temperature and LED Current

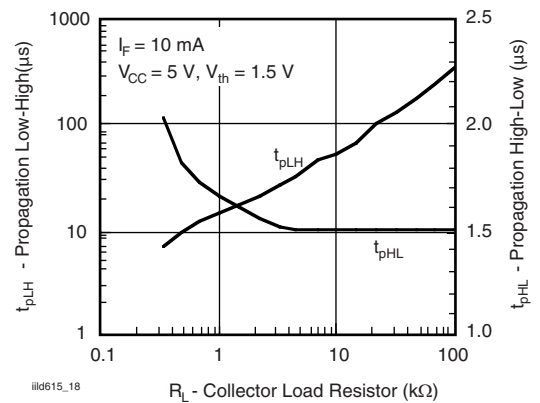

Fig. 19 - -2, -3, Propagation Delay vs. Collector Load Resistor

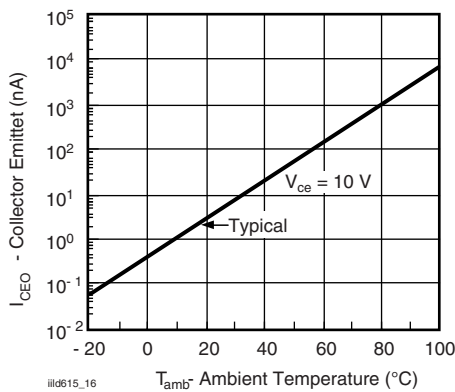

Fig. 17 - Collector Emitter Leakage vs. Temperature

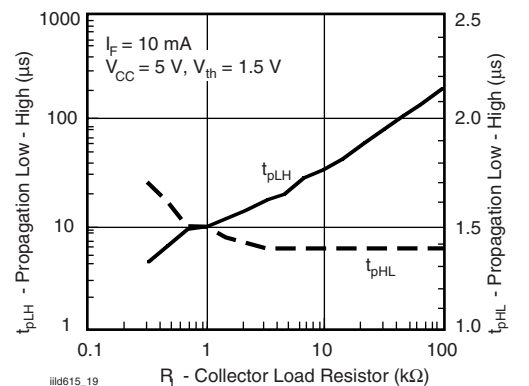

Fig. 20 - -4, Propagation Delay vs. Collector Load Resistor

ILD615, ILQ615



Vishay Semiconductors Optocoupler, Phototransistor Output
(Dual, Quad Channel)

PACKAGE DIMENSIONS in millimeters

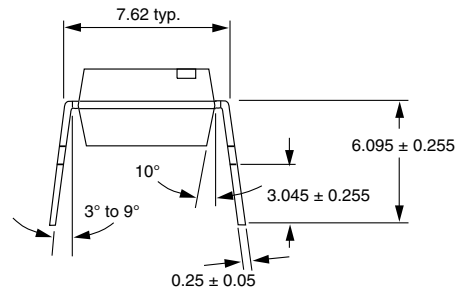
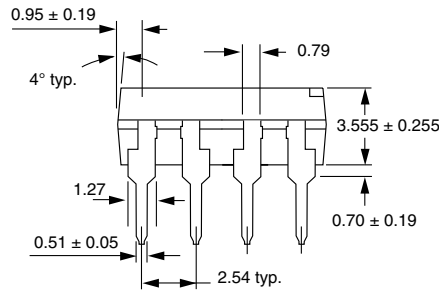
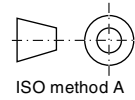
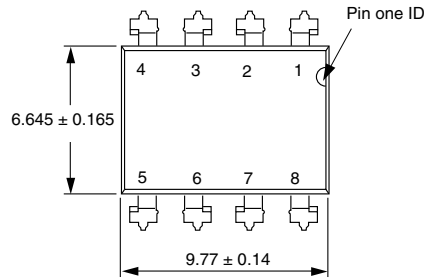

i178006

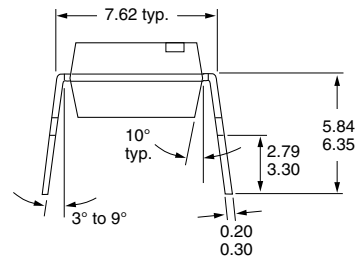
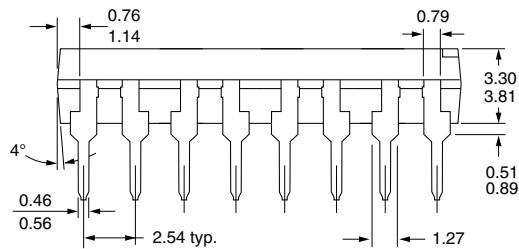
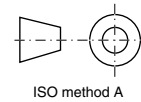
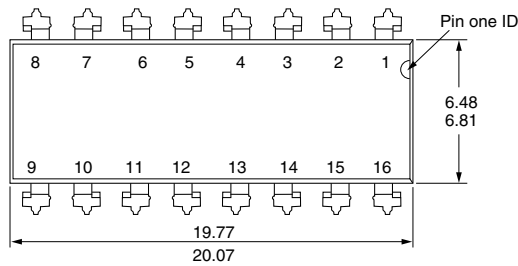

i178007

Option 6

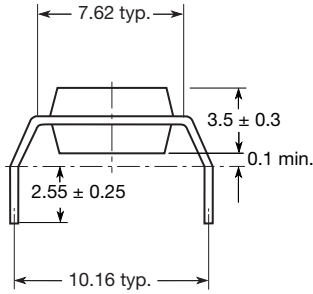

Option 7

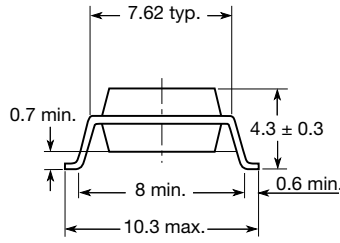

Option 9

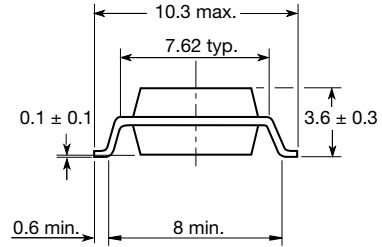

20802-22

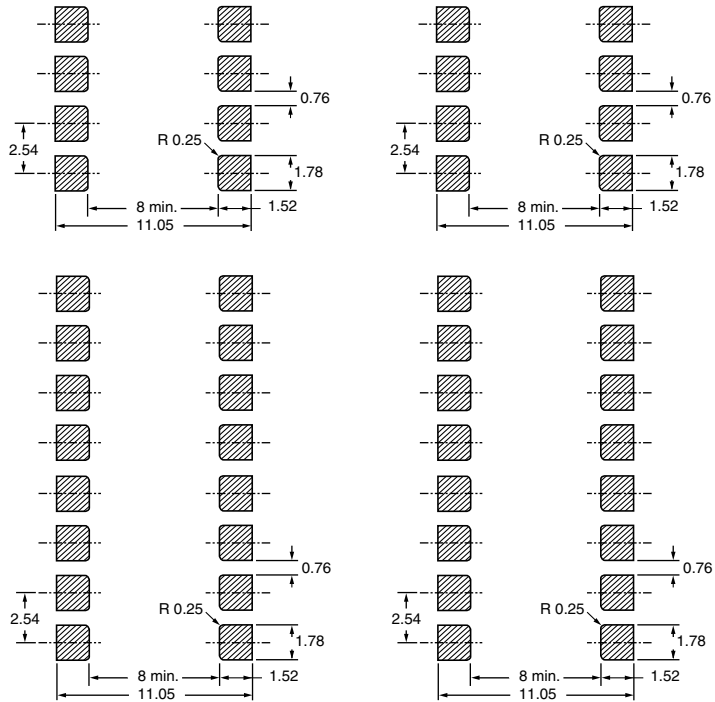

PACKAGE MARKING

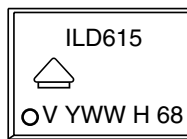

21764-88

Notes

- Only options 1 and 7 reflected in the package marking.
- The VDE Logo is only marked on option1 parts.
- Tape and reel suffix (T) is not part of the package marking.



Disclaimer

ALL PRODUCT, PRODUCT SPECIFICATIONS AND DATA ARE SUBJECT TO CHANGE WITHOUT NOTICE TO IMPROVE RELIABILITY, FUNCTION OR DESIGN OR OTHERWISE.

Vishay Intertechnology, Inc., its affiliates, agents, and employees, and all persons acting on its or their behalf (collectively, "Vishay"), disclaim any and all liability for any errors, inaccuracies or incompleteness contained in any datasheet or in any other disclosure relating to any product.

Vishay makes no warranty, representation or guarantee regarding the suitability of the products for any particular purpose or the continuing production of any product. To the maximum extent permitted by applicable law, Vishay disclaims (i) any and all liability arising out of the application or use of any product, (ii) any and all liability, including without limitation special, consequential or incidental damages, and (iii) any and all implied warranties, including warranties of fitness for particular purpose, non-infringement and merchantability.

Statements regarding the suitability of products for certain types of applications are based on Vishay's knowledge of typical requirements that are often placed on Vishay products in generic applications. Such statements are not binding statements about the suitability of products for a particular application. It is the customer's responsibility to validate that a particular product with the properties described in the product specification is suitable for use in a particular application. Parameters provided in datasheets and / or specifications may vary in different applications and performance may vary over time. All operating parameters, including typical parameters, must be validated for each customer application by the customer's technical experts. Product specifications do not expand or otherwise modify Vishay's terms and conditions of purchase, including but not limited to the warranty expressed therein.

Except as expressly indicated in writing, Vishay products are not designed for use in medical, life-saving, or life-sustaining applications or for any other application in which the failure of the Vishay product could result in personal injury or death. Customers using or selling Vishay products not expressly indicated for use in such applications do so at their own risk. Please contact authorized Vishay personnel to obtain written terms and conditions regarding products designed for such applications.

No license, express or implied, by estoppel or otherwise, to any intellectual property rights is granted by this document or by any conduct of Vishay. Product names and markings noted herein may be trademarks of their respective owners.