

6th Generation CoolSiC™

650V SiC Schottky Diode

The CoolSiC™ generation 6 (G6) is the leading edge technology from Infineon for the SiC Schottky barrier diodes. The Infineon proprietary innovative G5 technology was enhanced in G6 by introducing further advancements like a novel Schottky metal system. The result is a family of products with improved efficiency over all load conditions, resulting from a lower figure of merit ($Q_C \times V_F$). The CoolSiC™ Schottky diode 650 V G6 has been designed to complement our 600 V and 650 V CoolMOS™ 7 families, meeting the most stringent application requirements in this voltage range.

Table 1 Key performance parameters

Parameter	Value	Unit
V_{RRM}	650	V
Q_C ($V_R = 400$ V)	17.1	nC
E_C ($V_R = 400$ V)	3.2	μJ
I_F ($T_C \leq 140$ °C, $D = 1$)	12	A
V_F ($I_F = 12$ A, $T_j = 25$ °C)	1.25	V

Table 2 Package information

Type / ordering Code	Package	Marking
IDH12G65C6	PG-TO220-2	D1265C6

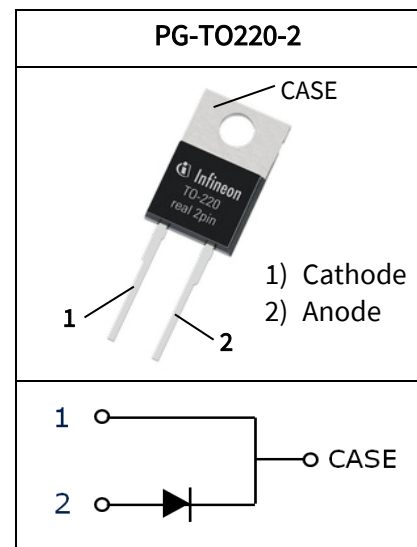

Features

- Best in class forward voltage (1.25 V)
- Best in class figure of merit ($Q_C \times V_F$)
- High dv/dt ruggedness (150 V/ns)

Benefits

- System efficiency improvement
- System cost and size savings due to the reduced cooling requirements
- Enabling higher frequency and increased power density

Potential Applications

- Power factor correction in SMPS
- Solar inverter
- Uninterruptible power supply

Product Validation

- Qualified for industrial applications according to the relevant tests of JEDEC (J-STD20 and JESD22)



Table of Content

1	Maximum ratings	3
2	Thermal characteristics	3
3	Electrical characteristics	4
3.1	Static characteristics	4
3.2	AC characteristics	4
4	Diagrams	5
5	Simplified forward characteristic	7
6	Package outlines	8

1 Maximum ratings

Table 3 Maximum ratings

Parameter	Symbol	Values			Unit	Note/Test condition
		Min.	Typ.	Max.		
Continuous forward current	I_F	-	-	12	A	$T_C \leq 140\text{ °C}, D = 1$
		-	-	15		$T_C \leq 125\text{ °C}, D = 1$
		-	-	27		$T_C \leq 25\text{ °C}, D = 1$
Surge-repetitive forward current, sine halfwave ¹	$I_{F,RM}$	-	-	53		$T_C = 25\text{ °C}, t_p = 10\text{ ms}$
Surge non-repetitive forward current, sine halfwave	$I_{F,SM}$	-	-	64		$T_C = 25\text{ °C}, t_p = 10\text{ ms}$
		-	-	51		$T_C = 150\text{ °C}, t_p = 10\text{ ms}$
Non-repetitive peak forward current	$I_{F,max}$	-	-	630	$T_C = 25\text{ °C}, t_p = 10\text{ }\mu\text{s}$	
i^2t value	$\int i^2 dt$	-	-	21	A ² s	$T_C = 25\text{ °C}, t_p = 10\text{ ms}$
		-	-	13		$T_C = 150\text{ °C}, t_p = 10\text{ ms}$
Repetitive peak reverse voltage	V_{RRM}	-	-	650	V	$T_C = 25\text{ °C}$
Diode dv/dt ruggedness	dv/dt	-	-	150	V/ns	$V_R = 0..480\text{ V}$
Power dissipation	P_{tot}	-	-	81	W	$T_C = 25\text{ °C}, R_{thJC,max}$
Operating and storage temperature	T_j	-55	-	175	°C	-
	T_{stg}					
Mounting torque	-	-	-	70	Ncm	M3 screw

2 Thermal characteristics

Table 4 Thermal characteristics (PG-TO-220-2)

Parameter	Symbol	Values			Unit	Note/Test condition
		Min.	Typ.	Max.		
Thermal resistance, junction-case	R_{thJC}	-	1.1	1.9	K/W	-
Thermal resistance, junction-ambient	R_{thJA}	-	-	62		leaded
Soldering temperature, wavesoldering only allowed at leads	T_{sold}	-	-	260	°C	1.6 mm (0.063 in.) from case for 10 s

¹ The surge-repetitive forward current test was performed with 1000 pulses (half-wave rectified sine with the 10 ms period).

3 Electrical characteristics

3.1 Static characteristics

Table 5 Static characteristics

Parameter	Symbol	Values			Unit	Note/Test condition
		Min.	Typ.	Max.		
DC blocking voltage	V_{DC}	650	–	–	V	$T_j = 25\text{ °C}$
Diode forward voltage	V_F	–	1.25	1.35		$I_F = 12\text{ A}, T_j = 25\text{ °C}$
		–	1.5	–		$I_F = 12\text{ A}, T_j = 150\text{ °C}$
Reverse current	I_R	–	1.2	40	μA	$V_R = 420\text{ V}, T_j = 25\text{ °C}$
		–	40	–		$V_R = 420\text{ V}, T_j = 125\text{ °C}$
		–	92	–		$V_R = 420\text{ V}, T_j = 150\text{ °C}$

3.2 AC characteristics

Table 6 AC characteristics

Parameter	Symbol	Values			Unit	Note/Test Condition
		Min.	Typ.	Max.		
Total capacitive charge	Q_C	–	17.1	–	nC	$V_R = 400\text{ V}, T_j = 150\text{ °C},$ $di/dt = 200\text{ A}/\mu\text{s}, I_F \leq I_{F,MAX}$
Total Capacitance	C	–	594	–	pF	$V_R = 1\text{ V}, f = 1\text{ MHz},$ $T_j = 25\text{ °C}$
		–	35	–		$V_R = 300\text{ V}, f = 1\text{ MHz},$ $T_j = 25\text{ °C}$
		–	34	–		$V_R = 600\text{ V}, f = 1\text{ MHz},$ $T_j = 25\text{ °C}$

4 Diagrams

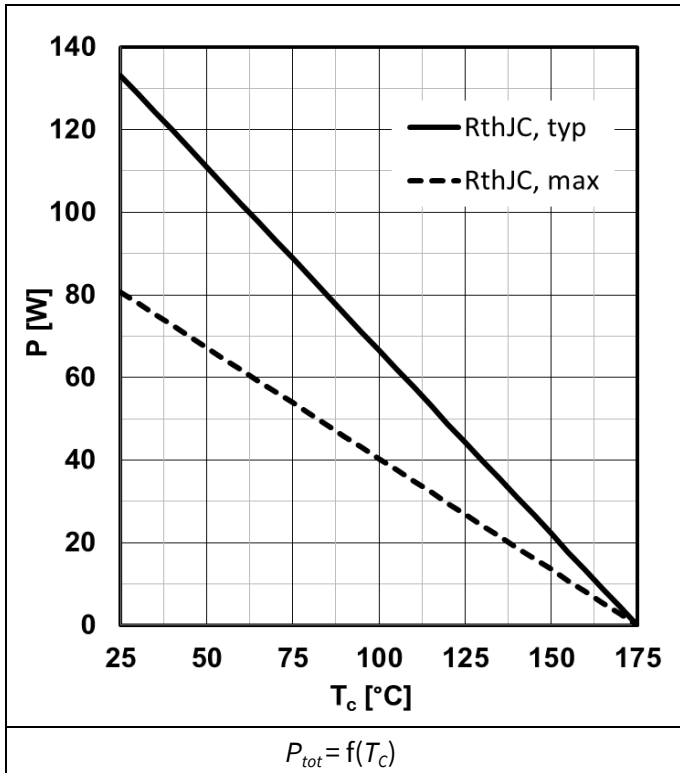

Figure 1 Power dissipation

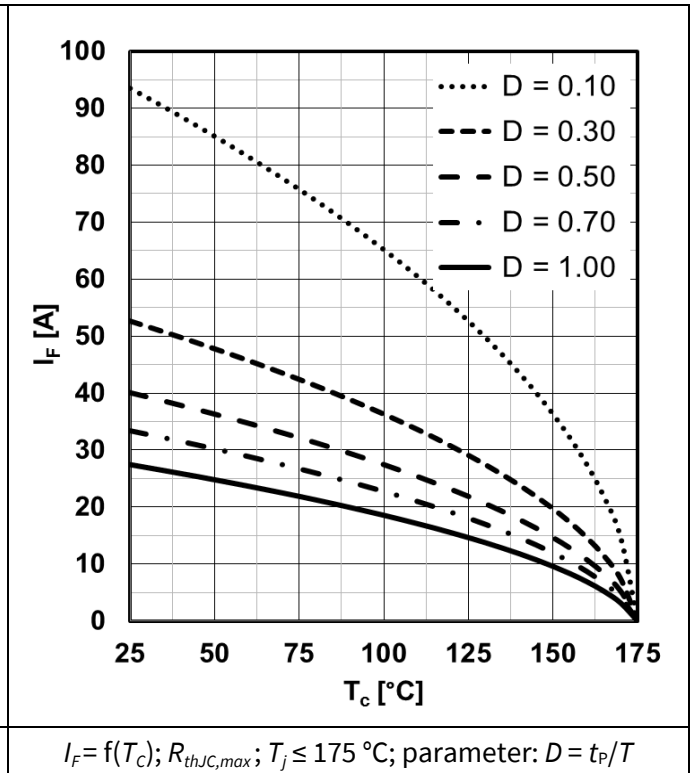

Figure 2 Max. forward current

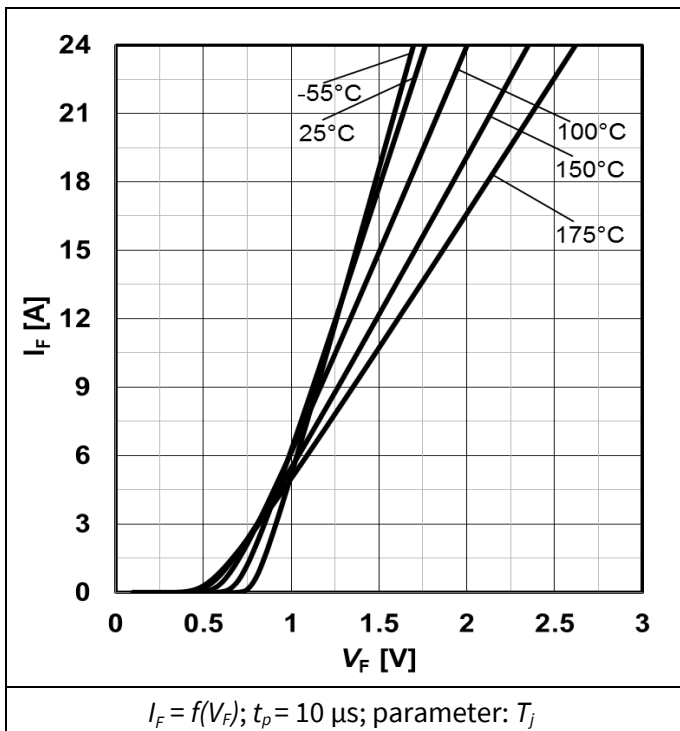

Figure 3 Typ. forward characteristics

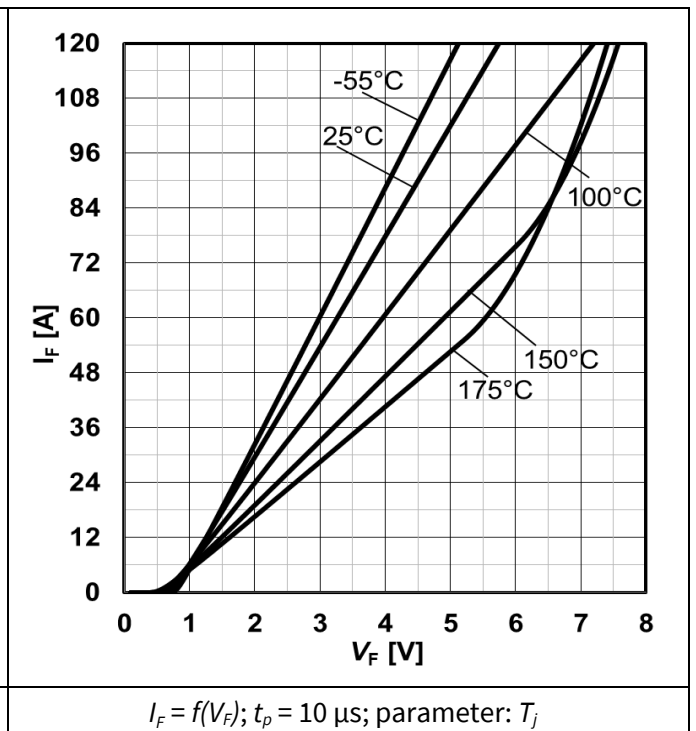

Figure 4 Typ. forward characteristics in surge current

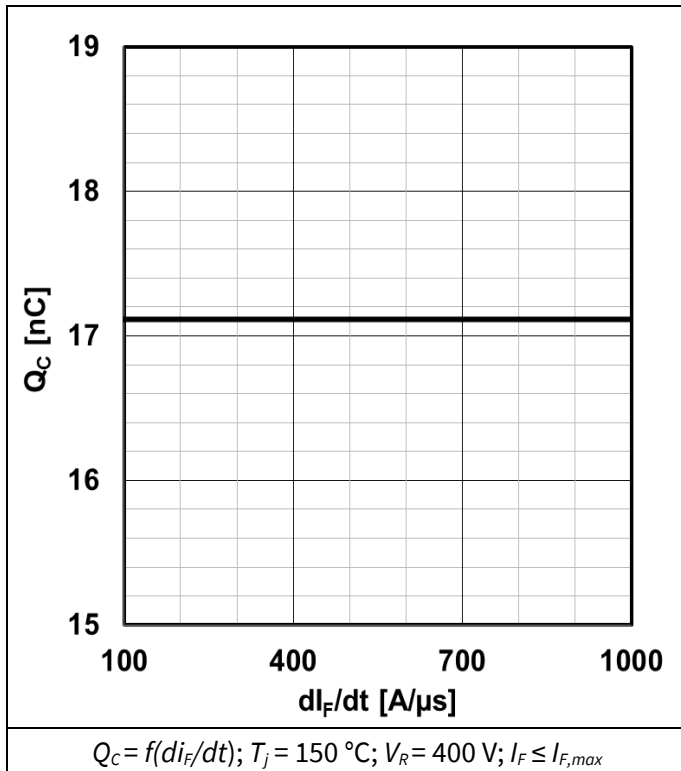

Figure 5 Typ. cap. charge vs. current slope

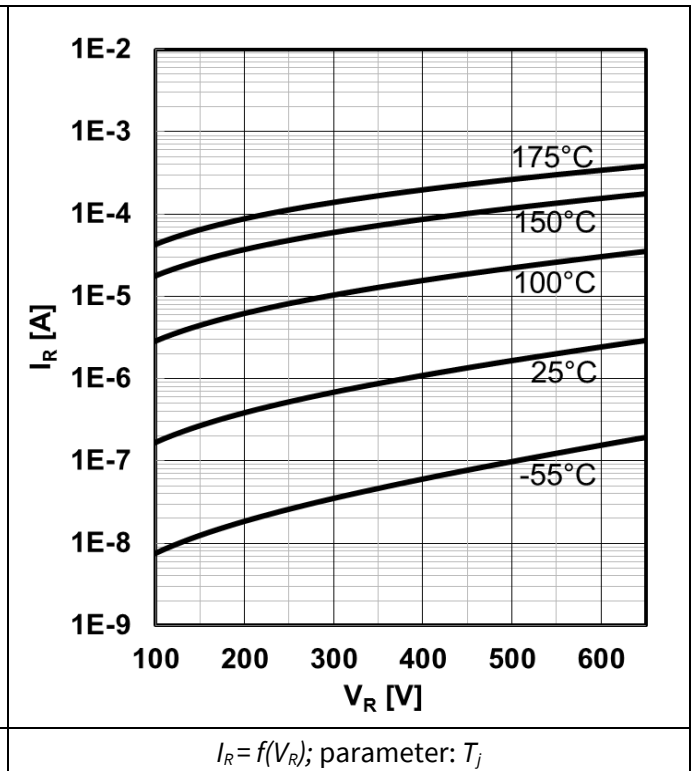

Figure 6 Typ. reverse current vs. reverse voltage

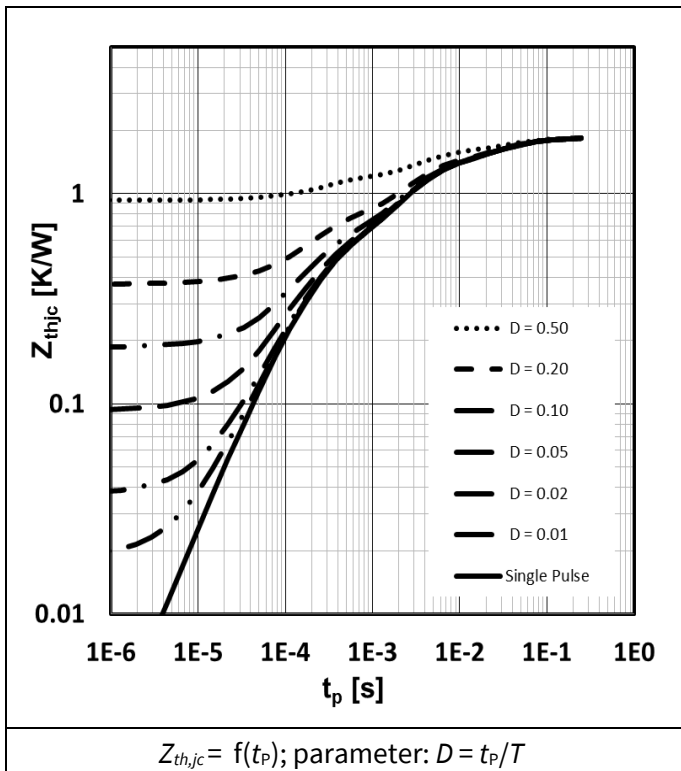

Figure 7 Max. transient thermal impedance

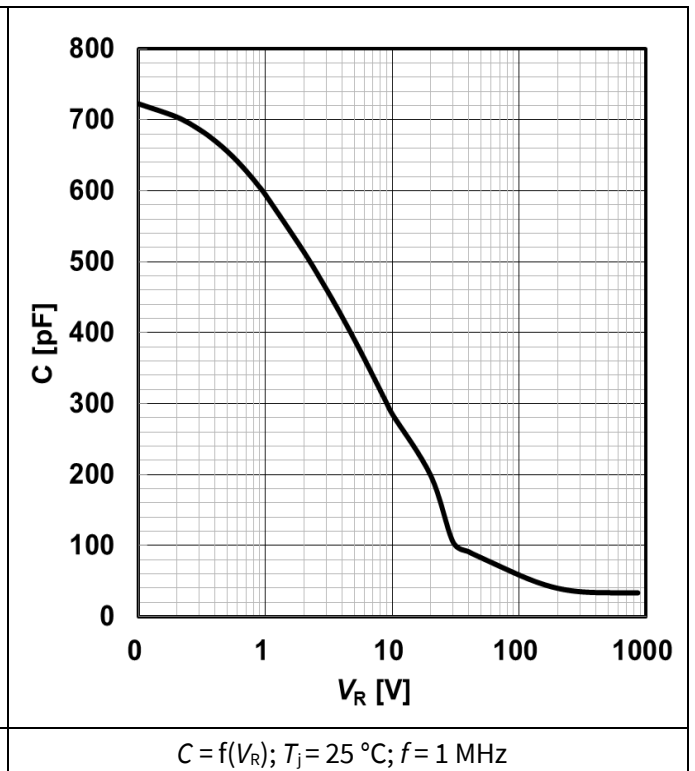

Figure 8 Typ. capacitance vs. reverse voltage

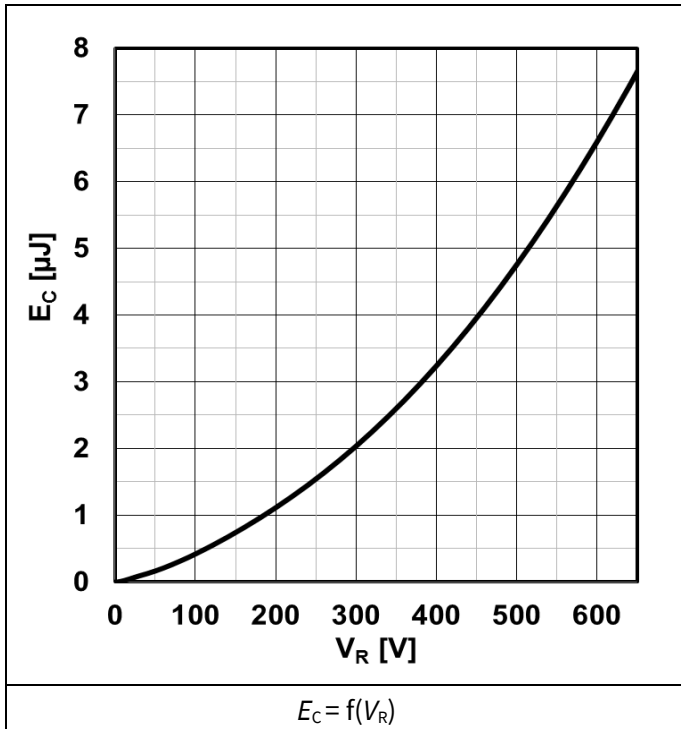

Figure 9 Typ. capacitance stored energy

5 Simplified forward characteristic

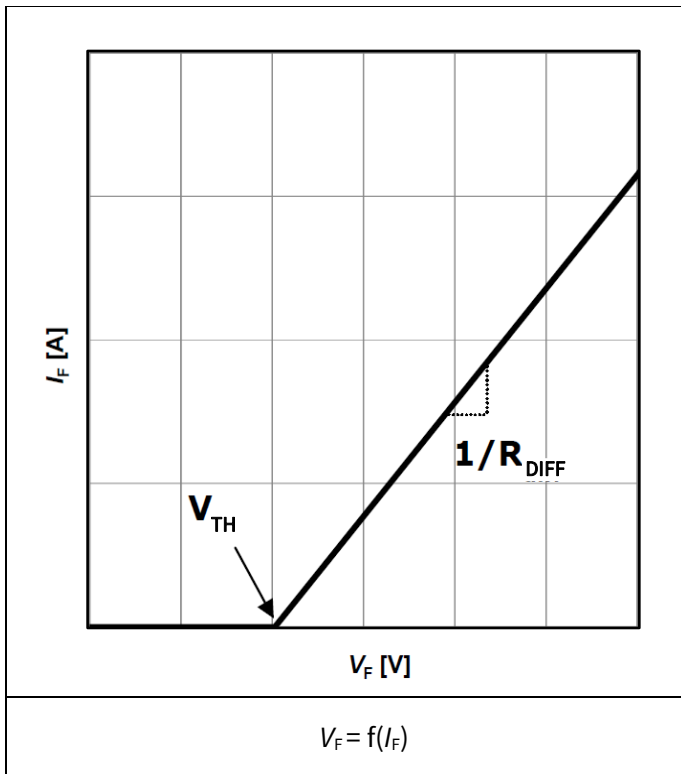

Figure 10 Equivalent forward current curve

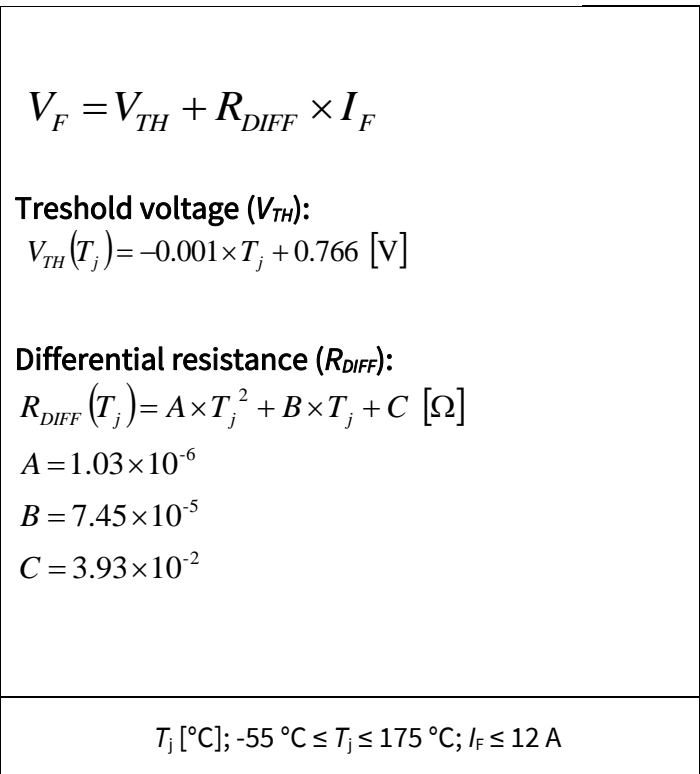

Figure 11 Mathematical Equation

6 Package outlines

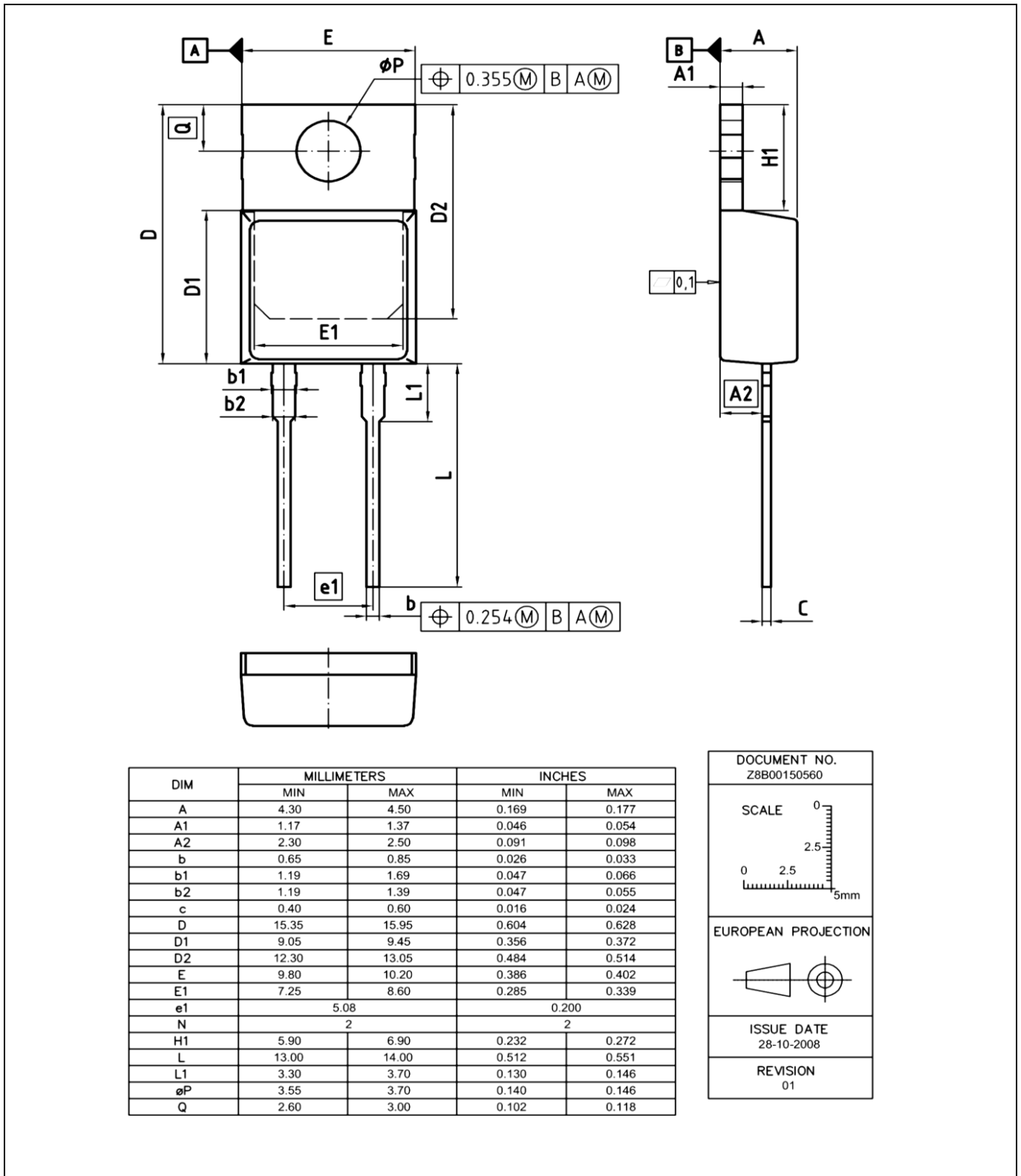

Figure 12 Outlines of the package PG-TO220-2, dimensions in mm/inches

Revision History

Major changes since the last revision

Revision	Date	Subject (major changes since last revision)
2.0	2017-05-23	Release of final version

Other Trademarks

All referenced product or service names and trademarks are the property of their respective owners.

Edition 2017-05-23

Published by

**Infineon Technologies AG
81726 München, Germany**

**© 2017 Infineon Technologies AG.
All Rights Reserved.**

Do you have a question about this document?

Email: erratum@infineon.com

Document reference

IMPORTANT NOTICE

The information given in this document shall in no event be regarded as a guarantee of conditions or characteristics ("Beschaffenheitsgarantie").

With respect to any examples, hints or any typical values stated herein and/or any information regarding the application of the product, Infineon Technologies hereby disclaims any and all warranties and liabilities of any kind, including without limitation warranties of non-infringement of intellectual property rights of any third party.

In addition, any information given in this document is subject to customer's compliance with its obligations stated in this document and any applicable legal requirements, norms and standards concerning customer's products and any use of the product of Infineon Technologies in customer's applications.

The data contained in this document is exclusively intended for technically trained staff. It is the responsibility of customer's technical departments to evaluate the suitability of the product for the intended application and the completeness of the product information given in this document with respect to such application.

For further information on the product, technology, delivery terms and conditions and prices please contact your nearest Infineon Technologies office (www.infineon.com).

WARNINGS

Due to technical requirements products may contain dangerous substances. For information on the types in question please contact your nearest Infineon Technologies office.

Except as otherwise explicitly approved by Infineon Technologies in a written document signed by authorized representatives of Infineon Technologies, Infineon Technologies' products may not be used in any applications where a failure of the product or any consequences of the use thereof can reasonably be expected to result in personal injury.