

GN 843.1

Plunger clamps



GN 843.1-AS

GN 843.1-ASW

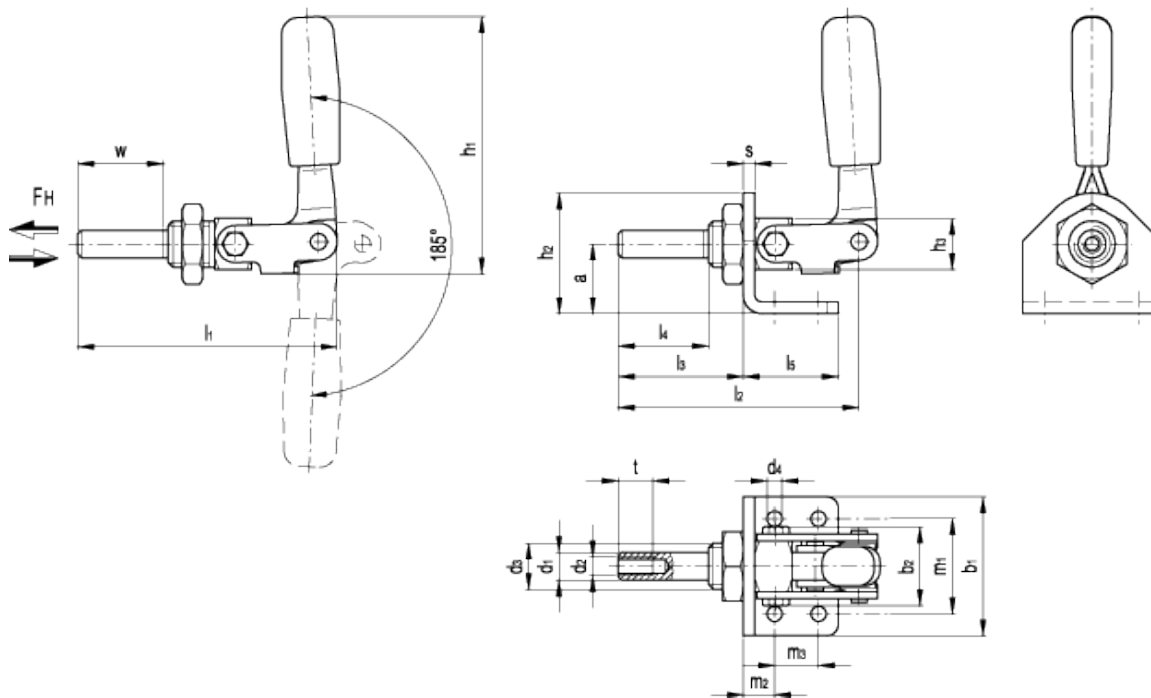

technical informations

Body

Zinc-plated steel, blue passivated.

Sheet metal parts

Zinc-plated case-hardened steel C10, blue passivated.

- Version AS: without mounting bracket.
- Version ASW: with mounting bracket.

Handle

Oil resistant, solid plastic, red colour.

Features and applications

All moving parts are lubricated with a special grease.

Plunger clamps GN 843.1 can be mounted on a mounting bracket (Version ASW) or directly on the jig.

The centre bush fixing method allows the operating handle to be turned into the most favourable position.

Plunger clamps GN 843.1 replace the standard GN 843.

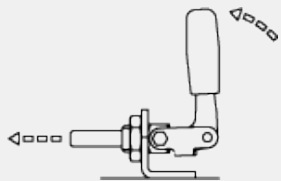

Standard Elements	Main dimensions																				Stroke	Holding force	Weight
Description	a	b ₁	b ₂	d ₁	d ₂	d ₃	d ₄	h ₁	h ₂	h ₃	l ₁	l ₂	l ₃	l ₄	l ₅	m ₁	m ₂	m ₃	s	t	w	FH [N]	g
GN 843.1-80-AS	-	-	30	10	M6	M16x1.5	-	70	-	19	71	65	34	22	-	-	-	-	-	12	21	3000	132
GN 843.1-165-AS	-	-	35	12	M8	M20x1.5	-	110	-	22	113	105	54	39	-	-	-	-	-	15	38	5400	331
GN 843.1-340-AS	-	-	47.6	16	M10	M24x2	-	145	-	30	173	162	85	68	-	-	-	-	-	18	66	7000	841
GN 843.1-80-ASW	24	35	30	10	M6	M16x1.5	5.5	70	38.5	19	71	65	34	22	22	20	12	-	4	12	21	3000	178
GN 843.1-165-ASW	32	60	35	12	M8	M20x1.5	6.5	110	50	22	113	105	54	39	41	41	13.5	19	5	15	38	5400	483
GN 843.1-340-ASW	48	75	47.6	16	M10	M24x2	8.5	145	70	30	173	162	85	68	59	55	19	25	5	18	66	7000	1127



ELESA and GANTER models all rights reserved in accordance with the law. Always mention the source when reproducing our drawings.

STANDARD MACHINE ELEMENTS WORLDWIDE