

Standard Rectifier

1~ Rectifier	
V_{RRM}	= 1600 V
I_{DAV}	= 25 A
I_{FSM}	= 370 A

1~ Rectifier Bridge

Part number

GBO25-16NO1

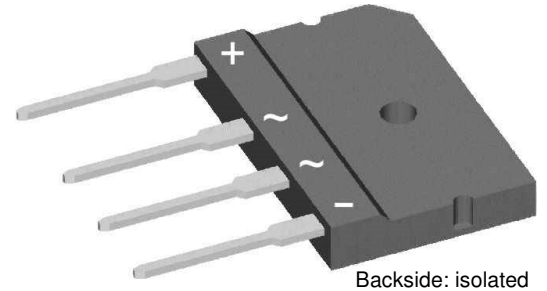

Backside: isolated

E72873

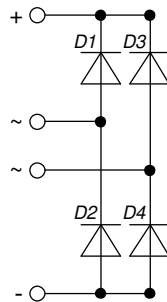

Features / Advantages:

- Low forward voltage drop
- Planar passivated chips
- Easy to mount with one screw
- Space and weight savings

Applications:

- Supplies for DC power equipment
- Input rectifiers for PWM inverter
- Battery DC power supplies
- Field supply for DC motors

Package: GBFP

- Isolation Voltage: 2500 V~
- Industry standard outline
- RoHS compliant
- Epoxy meets UL 94V-0
- Soldering pins for PCB mounting
- Base plate: Plastic overmolded tab
- Reduced weight

Terms and Conditions of Usage

The data contained in this product data sheet is exclusively intended for technically trained staff. The user will have to evaluate the suitability of the product for the intended application and the completeness of the product data with respect to his application. The specifications of our components may not be considered as an assurance of component characteristics. The information in the valid application- and assembly notes must be considered. Should you require product information in excess of the data given in this product data sheet or which concerns the specific application of your product, please contact your local sales office.

Due to technical requirements our product may contain dangerous substances. For information on the types in question please contact your local sales office.

Should you intend to use the product in aviation, in health or life endangering or life support applications, please notify. For any such application we urgently recommend

- to perform joint risk and quality assessments;

- the conclusion of quality agreements;

- to establish joint measures of an ongoing product survey, and that we may make delivery dependent on the realization of any such measures.

Rectifier				Ratings			
Symbol	Definition	Conditions		min.	typ.	max.	Unit
V_{RSM}	max. non-repetitive reverse blocking voltage					1700	V
V_{RRM}	max. repetitive reverse blocking voltage					1600	V
I_R	reverse current	$V_R = 1600$ V		$T_{VJ} = 25^\circ\text{C}$		40	μA
		$V_R = 1600$ V		$T_{VJ} = 150^\circ\text{C}$		1.5	mA
V_F	forward voltage drop	$I_F = 10$ A		$T_{VJ} = 25^\circ\text{C}$		1.06	V
		$I_F = 20$ A				1.17	V
		$I_F = 10$ A		$T_{VJ} = 150^\circ\text{C}$		0.92	V
		$I_F = 20$ A				1.09	V
I_{DAV}	bridge output current	$T_C = 105^\circ\text{C}$		$T_{VJ} = 175^\circ\text{C}$		25	A
		rectangular	d = 0.5				
V_{FO}	threshold voltage			$T_{VJ} = 175^\circ\text{C}$		0.74	V
r_F	slope resistance					16.3	m Ω
						} for power loss calculation only	
R_{thJC}	thermal resistance junction to case					4.3	K/W
R_{thCH}	thermal resistance case to heatsink				0.50		K/W
P_{tot}	total power dissipation			$T_C = 25^\circ\text{C}$		35	W
I_{FSM}	max. forward surge current	t = 10 ms; (50 Hz), sine		$T_{VJ} = 45^\circ\text{C}$		370	A
		t = 8,3 ms; (60 Hz), sine		$V_R = 0$ V		400	A
		t = 10 ms; (50 Hz), sine		$T_{VJ} = 150^\circ\text{C}$		315	A
		t = 8,3 ms; (60 Hz), sine		$V_R = 0$ V		340	A
I^2t	value for fusing	t = 10 ms; (50 Hz), sine		$T_{VJ} = 45^\circ\text{C}$		685	A ² s
		t = 8,3 ms; (60 Hz), sine		$V_R = 0$ V		665	A ² s
		t = 10 ms; (50 Hz), sine		$T_{VJ} = 150^\circ\text{C}$		495	A ² s
		t = 8,3 ms; (60 Hz), sine		$V_R = 0$ V		480	A ² s
C_J	junction capacitance	$V_R = 400$ V; f = 1 MHz		$T_{VJ} = 25^\circ\text{C}$		10	pF

Package GBFP		Ratings				
Symbol	Definition	Conditions	min.	typ.	max.	Unit
I_{RMS}	RMS current	per terminal			70	A
T_{VJ}	virtual junction temperature		-40		175	°C
T_{op}	operation temperature		-40		150	°C
T_{stg}	storage temperature		-40		150	°C
Weight				7		g
M_D	mounting torque		0.5		0.8	Nm
F_C	mounting force with clip		20		120	N
$d_{Spp/App}$	creepage distance on surface striking distance through air	terminal to terminal	4.9			mm
$d_{Spb/Apb}$		terminal to backside	2.5			mm
V_{ISOL}	isolation voltage	t = 1 second	2500			V
		t = 1 minute	2100			V
		50/60 Hz, RMS; $I_{ISOL} \leq 1$ mA				
R_{thJA}	thermal resistance junction to ambient			50		K/W

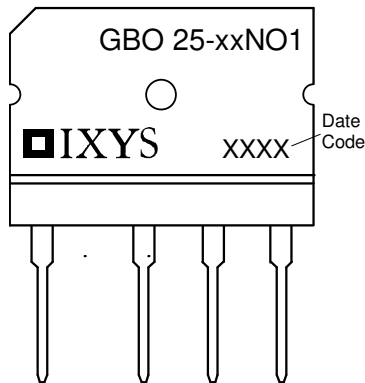

Ordering	Ordering Number	Marking on Product	Delivery Mode	Quantity	Code No.
Standard	GBO25-16NO1	GBO25-16NO1	Tube	16	500240

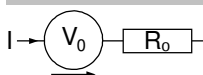
Equivalent Circuits for Simulation
** on die level*
 $T_{VJ} = 175\text{ °C}$

Rectifier

$V_{0\ max}$	threshold voltage	0.74	V
$R_{0\ max}$	slope resistance *	13.7	mΩ

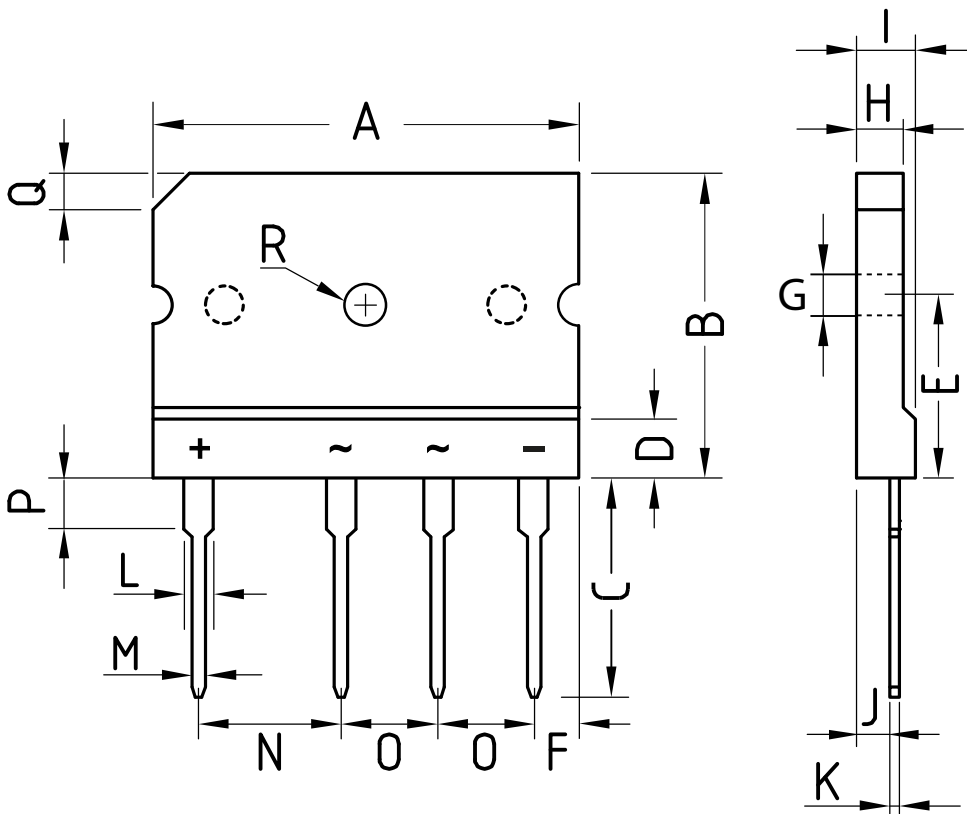
Outlines GBFP



DIM.	MIN.	MAX.
A	29.7	30.3
B	19.7	20.3
C	17.0	18.0
D	4.7	4.9
E	10.8	11.2
F	2.3	2.7
G	3.1	3.4
H	3.4	3.8
I	4.4	4.8
J	2.5	2.9
K	0.6	0.8
L	2.0	2.4
M	0.9	1.1
N	9.8	10.2
O	7.3	7.7
P	3.8	4.2
Q	(3.0) x 45°	
R (Ø)	3.1	3.4

All Dimensions in millimeter

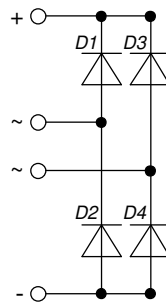

Rectifier

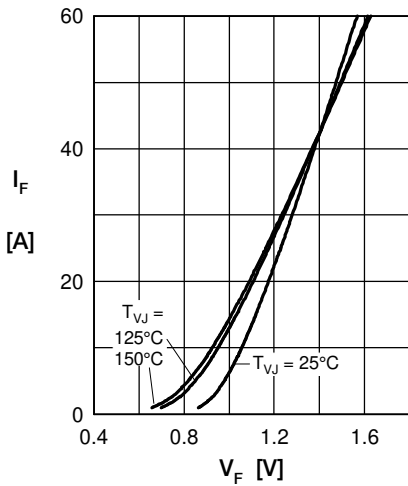

Fig. 1 Forward current vs. voltage drop per diode

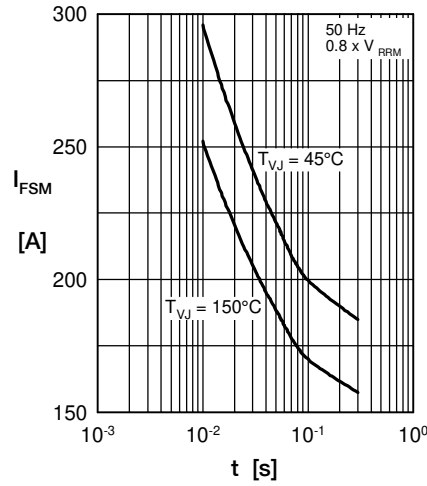

Fig. 2 Surge overload current vs. time per diode

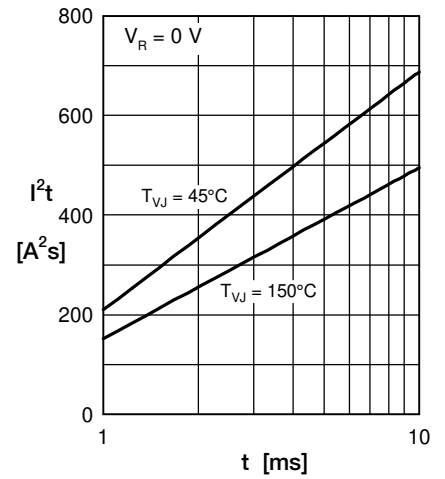

Fig. 3 I^2t vs. time per diode

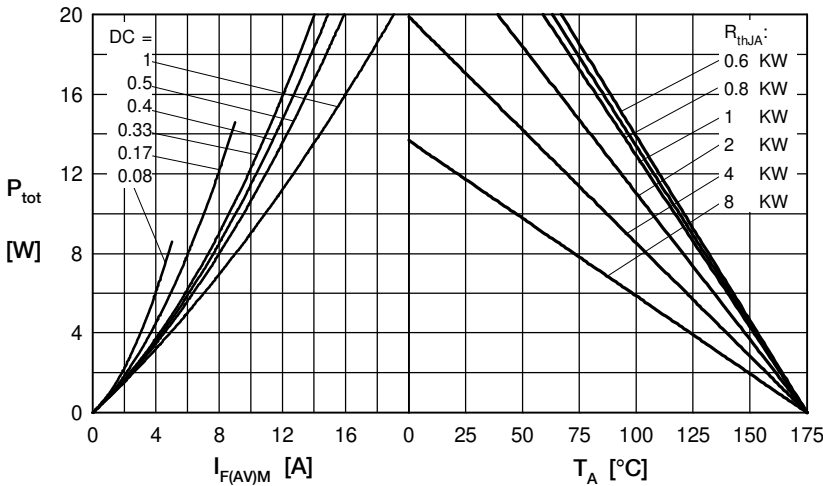

Fig. 4 Power dissipation vs. forward current and ambient temperature per diode

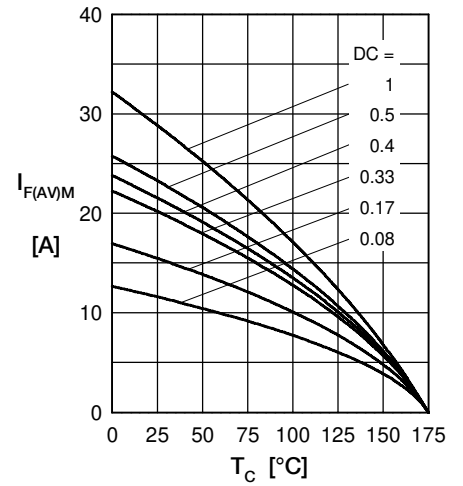

Fig. 5 Max. forward current vs. case temperature per diode

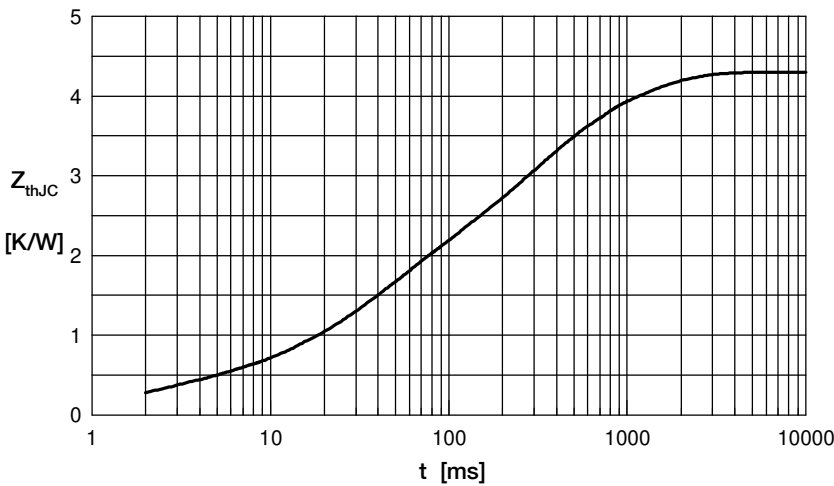

Fig. 6 Transient thermal impedance junction to case vs. time per diode

Constants for Z_{thJC} calculation:

i	R_{th} (K/W)	t_i (s)
1	0.302	0.002
2	1.252	0.032
3	1.582	0.227
4	1.164	0.820