

# 6,5 cm Breitbandlautsprecher / 2.5" Fullrange Speakers

## FRS 7 W Art. No. 2017 – 8 Ω

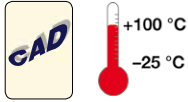

Art. No. 2312

**6,5 cm (2.5") Breitbandlautsprecher** mit ausgeglichenem Frequenzgang und sehr gutem Hochtonanteil. Besonders geeignet als Einbaulautsprecher für die Musikwiedergabe sowie zur Bestückung von ELA Zeilen. Tiefe Resonanzfrequenz und sehr großer Hub.

**Anwendungsmöglichkeiten:** Schmale ELA-Zeilen, Kontroll-Lautsprecher für elektronische Geräte, Modellbau, Elektronische Musikinstrumente

**Zubehör:** Schutzgitter (Art. No. 2312)

**6.5 cm (2.5") full range speaker** with balanced frequency response and very good highs. Especially suitable as built-in speaker for music reproduction and as driver for 100 V network column speakers. Very low resonance frequency and maximum cone displacement.

**Typical applications:** Narrow network column speakers, Control speaker for electronic devices, Model construction, Electronic musical instruments

**Accessories:** Protective grille (Art. No. 2312)

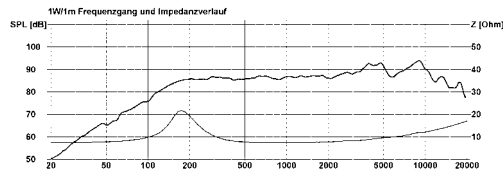
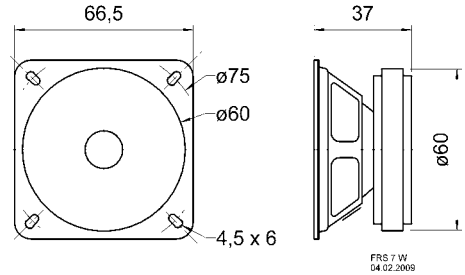
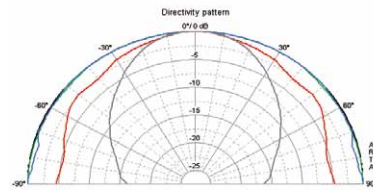

## FR 7 Art. No. 2015 – 4 Ω

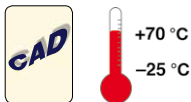

Art. No. 2312

**6,5 cm (2.5") Breitbandlautsprecher** mit geringer Einbautiefe und kleinem Magnet, daher besonders auch für den Einbau in beengten Platzverhältnissen geeignet. Gleichmäßiger Frequenzgang und guter Schalldruckpegel sowie sehr guter Hochtonanteil.

**Anwendungsmöglichkeiten:** Schmale ELA-Zeilen, Kontroll-Lautsprecher für elektronische Geräte, Modellbau, Elektronische Musikinstrumente. **Zubehör:** Schutzgitter (Art.-No. 2312)

**6.5 cm (2.5") full range speaker** minimal mounting depth and small magnet. Balanced frequency response and high efficiency. Very good high range response. Suitable in machines and other equipment where space is at a premium.

**Typical applications:** Narrow network column speakers, Control speaker for electronic devices, Model construction, Electronic musical instruments. **Accessories:** Grille (Art.-No. 2312).

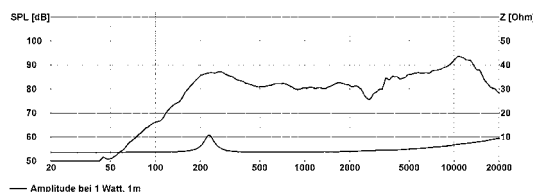
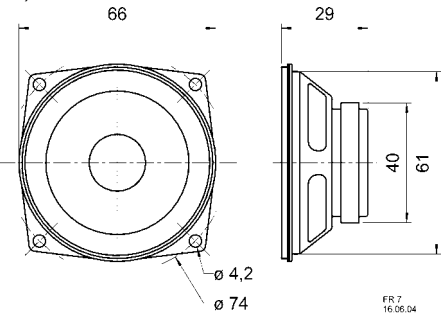
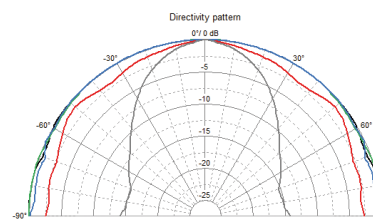

		FRS 7 W	FR 7
Nenn-/Musikbelastbarkeit	Rated/maximum power	8 W / 15 W	5 W / 10 W
Impedanz	Impedance	8 Ω	4 Ω
Übertragungsbereich (-10 dB)	Frequency response (-10 dB)	120-20000 Hz	130-20000 Hz
Mittlerer Schalldruckpegel	Mean sound pressure level	86 dB (1 W/1 m)	86 dB (1 W/1 m)
Grenzauslenkung x <sub>mechan</sub>	Excursion limit x <sub>mechan</sub>	± 2,5 mm	± 1 mm
Resonanzfrequenz	Resonance frequency	160 Hz	220 Hz
Obere Polplattenhöhe	Height of front pole-plate	2,5 mm	2,5 mm
Schwingspulendurchmesser	Voice coil diameter	14 mm Ø	14 mm Ø
Wickelhöhe	Height of winding	4,5 mm	2,5 mm
Schallwandöffnung	Cutout diameter	61 mm Ø	61 mm Ø
Gewicht netto	Net weight	0,22 kg	0,092 kg

Weitere Daten Seiten 156-157 / for further data see pages 156-157