



Is Now Part of



ON Semiconductor®

To learn more about ON Semiconductor, please visit our website at
www.onsemi.com

ON Semiconductor and the ON Semiconductor logo are trademarks of Semiconductor Components Industries, LLC dba ON Semiconductor or its subsidiaries in the United States and/or other countries. ON Semiconductor owns the rights to a number of patents, trademarks, copyrights, trade secrets, and other intellectual property. A listing of ON Semiconductor's product/patent coverage may be accessed at www.onsemi.com/site/pdf/Patent-Marking.pdf. ON Semiconductor reserves the right to make changes without further notice to any products herein. ON Semiconductor makes no warranty, representation or guarantee regarding the suitability of its products for any particular purpose, nor does ON Semiconductor assume any liability arising out of the application or use of any product or circuit, and specifically disclaims any and all liability, including without limitation special, consequential or incidental damages. Buyer is responsible for its products and applications using ON Semiconductor products, including compliance with all laws, regulations and safety requirements or standards, regardless of any support or applications information provided by ON Semiconductor. "Typical" parameters which may be provided in ON Semiconductor data sheets and/or specifications can and do vary in different applications and actual performance may vary over time. All operating parameters, including "Typicals" must be validated for each customer application by customer's technical experts. ON Semiconductor does not convey any license under its patent rights nor the rights of others. ON Semiconductor products are not designed, intended, or authorized for use as a critical component in life support systems or any FDA Class 3 medical devices or medical devices with a same or similar classification in a foreign jurisdiction or any devices intended for implantation in the human body. Should Buyer purchase or use ON Semiconductor products for any such unintended or unauthorized application, Buyer shall indemnify and hold ON Semiconductor and its officers, employees, subsidiaries, affiliates, and distributors harmless against all claims, costs, damages, and expenses, and reasonable attorney fees arising out of, directly or indirectly, any claim of personal injury or death associated with such unintended or unauthorized use, even if such claim alleges that ON Semiconductor was negligent regarding the design or manufacture of the part. ON Semiconductor is an Equal Opportunity/Affirmative Action Employer. This literature is subject to all applicable copyright laws and is not for resale in any manner.



April 2016

FODM8801A, FODM8801B, FODM8801C

OptoHiT™ Series, High-Temperature Phototransistor Optocoupler in Half-Pitch Mini-Flat 4-Pin Package

Features

- Utilizing Proprietary Process Technology to Achieve High Operating Temperature: up to 125°C
- Guaranteed Current Transfer Ratio (CTR) Specifications Across Full Temperature Range
 - Excellent CTR Linearity at High-Temperature
 - CTR at Very Low Input Current, I_F
- High Isolation Voltage Regulated by Safety Agency: C-UL / UL1577, 3750 VAC_{RMS} for 1 minute and DIN EN/IEC60747-5-5
- Compact Half-Pitch, Mini-Flat, 4-Pin Package (1.27 mm Lead Pitch, 2.4 mm Maximum Standoff Height)
- > 5 mm Creepage and Clearance Distance
- Applicable to Infrared Ray Reflow, 245°C

Applications

- Primarily Suited for DC-DC Converters
- Ground-Loop Isolation, Signal-Noise Isolation
- Communications – Adapters, Chargers
- Consumer – Appliances, Set-Top Boxes
- Industrial – Power Supplies, Motor Control, Programmable Logic Control

Description

In the OptoHiT™ series, the FODM8801 is a first-of-kind phototransistor, utilizing Fairchild's leading-edge proprietary process technology to achieve high operating temperature characteristics, up to 125°C. The optocoupler consists of an aluminum gallium arsenide (AlGaAs) infrared light-emitting diode (LED) optically coupled to a phototransistor, available in a compact half-pitch, mini-flat, 4-pin package. It delivers high current transfer ratio at very low input current. The input-output isolation voltage, V_{ISO} , is rated at 3750 VAC_{RMS}.

Schematic

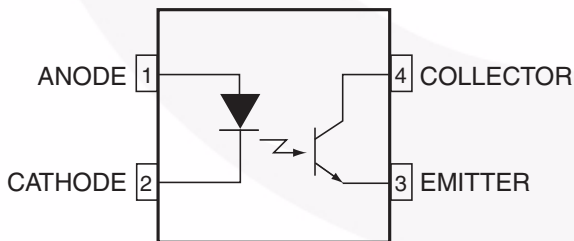

Figure 1. Schematic

Package

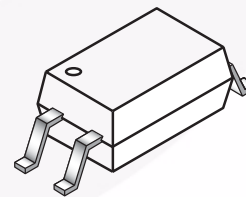

Figure 2. Half-Pitch Mini-Flat

Safety and Insulation Ratings

As per DIN EN/IEC 60747-5-5, this optocoupler is suitable for “safe electrical insulation” only within the safety limit data. Compliance with the safety ratings shall be ensured by means of protective circuits.

Parameter		Characteristics
Installation Classifications per DIN VDE 0110/1.89 Table 1, For Rated Mains Voltage	< 150 V _{RMS}	I–IV
	< 300 V _{RMS}	I–III
Climatic Classification		45/125/21
Pollution Degree (DIN VDE 0110/1.89)		2
Comparative Tracking Index		175

Symbol	Parameter	Value	Unit
V _{PR}	Input-to-Output Test Voltage, Method A, V _{IORM} × 1.6 = V _{PR} , Type and Sample Test with t _m = 10 s, Partial Discharge < 5 pC	848	V _{peak}
	Input-to-Output Test Voltage, Method B, V _{IORM} × 1.875 = V _{PR} , 100% Production Test with t _m = 1 s, Partial Discharge < 5 pC	1060	V _{peak}
V _{IORM}	Maximum Working Insulation Voltage	565	V _{peak}
V _{IOTM}	Highest Allowable Over-Voltage	6000	V _{peak}
	External Creepage	≥ 5	mm
	External Clearance	≥ 5	mm
DTI	Distance Through Insulation (Insulation Thickness)	≥ 0.5	mm
T _S	Case Temperature ⁽¹⁾	150	°C
I _{S,INPUT}	Input Current ⁽¹⁾	200	mA
P _{S,OUTPUT}	Output Power ⁽¹⁾	300	mW
R _{IO}	Insulation Resistance at T _S , V _{IO} = 500 V ⁽¹⁾	> 10 ⁹	Ω

Note:

1. Safety limit values – maximum values allowed in the event of a failure.

Absolute Maximum Ratings

Stresses exceeding the absolute maximum ratings may damage the device. The device may not function or be operable above the recommended operating conditions and stressing the parts to these levels is not recommended. In addition, extended exposure to stresses above the recommended operating conditions may affect device reliability. The absolute maximum ratings are stress ratings only. $T_A = 25^\circ\text{C}$ unless otherwise specified.

Symbol	Parameter	Value	Unit
Total Package			
T_{STG}	Storage Temperature	-40 to +150	$^\circ\text{C}$
T_{OPR}	Operating Temperature	-40 to +125	$^\circ\text{C}$
T_J	Junction Temperature	-40 to +140	$^\circ\text{C}$
T_{SOL}	Lead Solder Temperature	245 for 10 s	$^\circ\text{C}$
Emitter			
$I_{\text{F(average)}}$	Continuous Forward Current	20	mA
V_R	Reverse Input Voltage	6	V
PD_{LED}	Power Dissipation ⁽²⁾⁽⁴⁾	40	mW
Detector			
$I_{\text{C(average)}}$	Continuous Collector Current	30	mA
V_{CEO}	Collector-Emitter Voltage	75	V
V_{ECO}	Emitter-Collector Voltage	7	V
PD_{C}	Collector Power Dissipation ⁽³⁾⁽⁴⁾	150	mW

Notes:

- Derate linearly from 73°C at a rate of $0.24 \text{ mW}/^\circ\text{C}$
- Derate linearly from 73°C at a rate of $2.23 \text{ mW}/^\circ\text{C}$.
- Functional operation under these conditions is not implied. Permanent damage may occur if the device is subjected to conditions outside these ratings.

Recommended Operating Conditions

The Recommended Operating Conditions table defines the conditions for actual device operation. Recommended operating conditions are specified to ensure optimal performance to the datasheet specifications. Fairchild does not recommend exceeding them or designing to absolute maximum ratings.

Symbol	Parameter	Value	Unit
T_A	Operating Temperature	-40 to +125	$^\circ\text{C}$
$V_{\text{FL(OFF)}}$	Input Low Voltage	-5.0 to +0.8	V
I_{FH}	Input High Forward Current	1 to 10	mA

Isolation Characteristics

Symbol	Parameter	Conditions	Min.	Typ.	Max.	Unit
V_{ISO}	Input-Output Isolation Voltage	$f = 60 \text{ Hz}$, $t = 1 \text{ min.}$, $I_{\text{I-O}} \leq 10 \mu\text{A}$ ⁽⁵⁾⁽⁶⁾	3,750			VAC_{RMS}
R_{ISO}	Isolation Resistance	$V_{\text{I-O}} = 500 \text{ V}$ ⁽⁵⁾	10^{12}			Ω
C_{ISO}	Isolation Capacitance	$f = 1 \text{ MHz}$		0.3	0.5	pF

Notes:

- Device is considered a two-terminal device: pins 1 and 2 are shorted together and pins 3 and 4 are shorted together.
- $3,750 \text{ VAC}_{\text{RMS}}$ for 1 minute is equivalent to $4,500 \text{ VAC}_{\text{RMS}}$ for 1 second.

Electrical Characteristics

Apply over all recommended conditions ($T_A = -40^\circ\text{C}$ to $+125^\circ\text{C}$ unless otherwise specified).
All typical values are measured at $T_A = 25^\circ\text{C}$.

Symbol	Parameter	Conditions	Min.	Typ.	Max.	Unit
Emitter						
V_F	Forward Voltage	$I_F = 1\text{ mA}$	1.00	1.35	1.80	V
$\Delta V_F / \Delta T_A$	Forward-Voltage Coefficient	$I_F = 1\text{ mA}$		-1.6		mV / $^\circ\text{C}$
I_R	Reverse Current	$V_R = 6\text{ V}$			10	μA
C_T	Terminal Capacitance	$V = 0\text{ V}$, $f = 1\text{ MHz}$		30		pF
Detector						
BV_{CEO}	Collector-Emitter Breakdown Voltage	$I_C = 0.5\text{ mA}$, $I_F = 0\text{ mA}$	75	130		V
BV_{ECO}	Emitter-Collector Breakdown Voltage	$I_E = 100\ \mu\text{A}$, $I_F = 0\text{ mA}$	7	12		V
I_{CEO}	Collector Dark Current	$V_{CE} = 75\text{ V}$, $I_F = 0\text{ mA}$, $T_A = 25^\circ\text{C}$			100	nA
		$V_{CE} = 50\text{ V}$, $I_F = 0\text{ mA}$			50	μA
		$V_{CE} = 5\text{ V}$, $I_F = 0\text{ mA}$			30	μA
C_{CE}	Capacitance	$V_{CE} = 0\text{ V}$, $f = 1\text{ MHz}$		8		pF

Transfer Characteristics

Apply over all recommended conditions ($T_A = -40^\circ\text{C}$ to $+125^\circ\text{C}$ unless otherwise specified).
All typical values are measured at $T_A = 25^\circ\text{C}$.

Symbol	Parameter	Device	Conditions	Min.	Typ.	Max.	Unit
CTR _{CE}	Current Transfer Ratio (Collector-Emitter)	FODM8801A	$I_F = 1.0\text{ mA}, V_{CE} = 5\text{ V}$ @ $T_A = 25^\circ\text{C}$	80	120	160	%
			$I_F = 1.0\text{ mA}, V_{CE} = 5\text{ V}$	35	120	230	
			$I_F = 1.6\text{ mA}, V_{CE} = 5\text{ V}$	40	125		
			$I_F = 3.0\text{ mA}, V_{CE} = 5\text{ V}$	45	138		
		FODM8801B	$I_F = 1.0\text{ mA}, V_{CE} = 5\text{ V}$ @ $T_A = 25^\circ\text{C}$	130	195	260	
			$I_F = 1.0\text{ mA}, V_{CE} = 5\text{ V}$	65	195	360	
			$I_F = 1.6\text{ mA}, V_{CE} = 5\text{ V}$	70	202		
			$I_F = 3.0\text{ mA}, V_{CE} = 5\text{ V}$	75	215		
		FODM8801C	$I_F = 1.0\text{ mA}, V_{CE} = 5\text{ V}$ @ $T_A = 25^\circ\text{C}$	200	300	400	
			$I_F = 1.0\text{ mA}, V_{CE} = 5\text{ V}$	100	300	560	
			$I_F = 1.6\text{ mA}, V_{CE} = 5\text{ V}$	110	312		
			$I_F = 3.0\text{ mA}, V_{CE} = 5\text{ V}$	115	330		
CTR _{CE(SAT)}	Saturated Current Transfer Ratio (Collector-Emitter)	FODM8801A	$I_F = 1.0\text{ mA}, V_{CE} = 0.4\text{ V}$ @ $T_A = 25^\circ\text{C}$	65	108	150	%
			$I_F = 1.0\text{ mA}, V_{CE} = 0.4\text{ V}$	30	108		
			$I_F = 1.6\text{ mA}, V_{CE} = 0.4\text{ V}$	25	104		
			$I_F = 3.0\text{ mA}, V_{CE} = 0.4\text{ V}$	20	92		
		FODM8801B	$I_F = 1.0\text{ mA}, V_{CE} = 0.4\text{ V}$ @ $T_A = 25^\circ\text{C}$	90	168	245	
			$I_F = 1.0\text{ mA}, V_{CE} = 0.4\text{ V}$	45	168		
			$I_F = 1.6\text{ mA}, V_{CE} = 0.4\text{ V}$	40	155		
			$I_F = 3.0\text{ mA}, V_{CE} = 0.4\text{ V}$	35	132		
		FODM8801C	$I_F = 1.0\text{ mA}, V_{CE} = 0.4\text{ V}$ @ $T_A = 25^\circ\text{C}$	140	238	380	
			$I_F = 1.0\text{ mA}, V_{CE} = 0.4\text{ V}$	75	238		
			$I_F = 1.6\text{ mA}, V_{CE} = 0.4\text{ V}$	65	215		
			$I_F = 3.0\text{ mA}, V_{CE} = 0.4\text{ V}$	55	177		
V _{CE(SAT)}	Saturation Voltage	FODM8801A	$I_F = 1.0\text{ mA}, I_C = 0.3\text{ mA}$		0.17	0.40	V
			$I_F = 1.6\text{ mA}, I_C = 0.4\text{ mA}$		0.16	0.40	
			$I_F = 3.0\text{ mA}, I_C = 0.6\text{ mA}$		0.15	0.40	
		FODM8801B	$I_F = 1.0\text{ mA}, I_C = 0.45\text{ mA}$		0.17	0.40	
			$I_F = 1.6\text{ mA}, I_C = 0.6\text{ mA}$		0.16	0.40	
			$I_F = 3.0\text{ mA}, I_C = 1.0\text{ mA}$		0.16	0.40	
		FODM8801C	$I_F = 1.0\text{ mA}, I_C = 0.75\text{ mA}$		0.18	0.40	
			$I_F = 1.6\text{ mA}, I_C = 1.0\text{ mA}$		0.17	0.40	
			$I_F = 3.0\text{ mA}, I_C = 1.6\text{ mA}$		0.17	0.40	

Switching Characteristics

Apply over all recommended conditions ($T_A = -40^{\circ}\text{C}$ to $+125^{\circ}\text{C}$ unless otherwise specified).
 All typical values are measured at $T_A = 25^{\circ}\text{C}$.

Symbol	Parameter	Device	Conditions	Min.	Typ.	Max.	Unit
t_{ON}	Turn-On Time	All Devices	$I_F = 1.6 \text{ mA}$, $V_{\text{CC}} = 5 \text{ V}$, $R_L = 0.75 \text{ k}\Omega$	1	6	20	μs
			$I_F = 1.6 \text{ mA}$, $V_{\text{CC}} = 5 \text{ V}$, $R_L = 4.7 \text{ k}\Omega$		6		
t_{OFF}	Turn-Off Time	All Devices	$I_F = 1.6 \text{ mA}$, $V_{\text{CC}} = 5 \text{ V}$, $R_L = 0.75 \text{ k}\Omega$	1	6	20	μs
			$I_F = 1.6 \text{ mA}$, $V_{\text{CC}} = 5 \text{ V}$, $R_L = 4.7 \text{ k}\Omega$		40		
t_R	Output Rise Time (10% to 90%)	All Devices	$I_F = 1.6 \text{ mA}$, $V_{\text{CC}} = 5 \text{ V}$, $R_L = 0.75 \text{ k}\Omega$		5		μs
t_F	Output Fall Time (90% to 10%)	All Devices	$I_F = 1.6 \text{ mA}$, $V_{\text{CC}} = 5 \text{ V}$, $R_L = 0.75 \text{ k}\Omega$		5.5		μs
CM_H	Common-Mode Rejection Voltage (Transient Immunity) – Output High	All Devices	$T_A = 25^{\circ}\text{C}$, $I_F = 0 \text{ mA}$, $V_O > 2.0 \text{ V}$, $R_L = 4.7 \text{ k}\Omega$, $V_{\text{CM}} = 1000 \text{ V}^{(7)}$, Figure 16		20		$\text{kV} / \mu\text{s}$
CM_L	Common-Mode Rejection Voltage (Transient Immunity) – Output Low	All Devices	$T_A = 25^{\circ}\text{C}$, $I_F = 1.6 \text{ mA}$, $V_O < 0.8 \text{ V}$, $R_L = 4.7 \text{ k}\Omega$, $V_{\text{CM}} = 1000 \text{ V}^{(7)}$, Figure 16		20		$\text{kV} / \mu\text{s}$

Note:

7. Common-mode transient immunity at output high is the maximum tolerable positive dV_{cm}/dt on the leading edge of the common-mode impulse signal, V_{CM} , to assure that the output remains high.

Typical Performance Curves

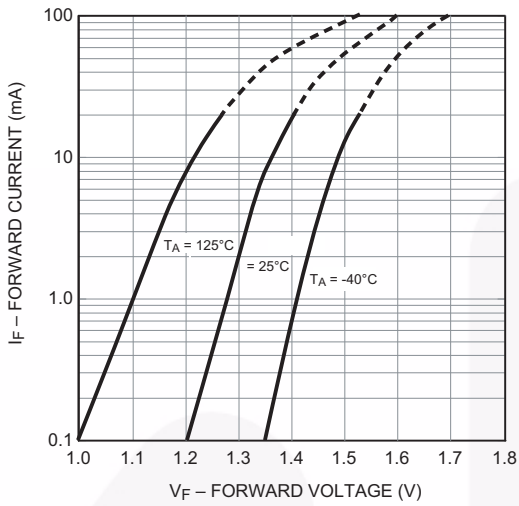

Figure 3. Forward Current vs. Forward Voltage

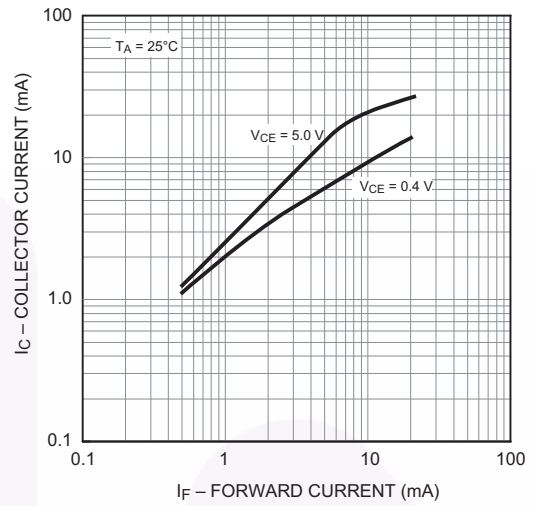

Figure 4. Collector Current vs. Forward Current

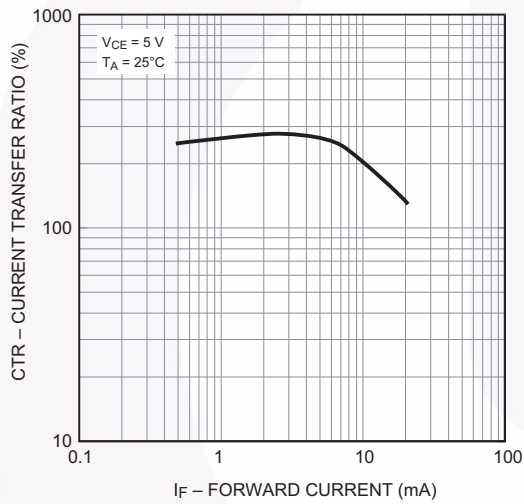

Figure 5. Current Transfer Ratio vs. Forward Current

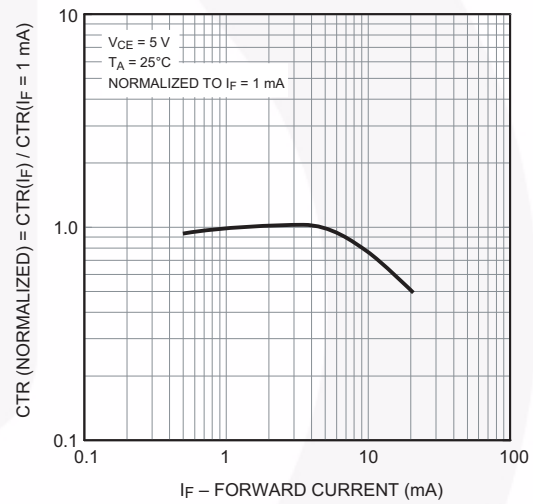

Figure 6. Normalized CTR vs. Forward Current

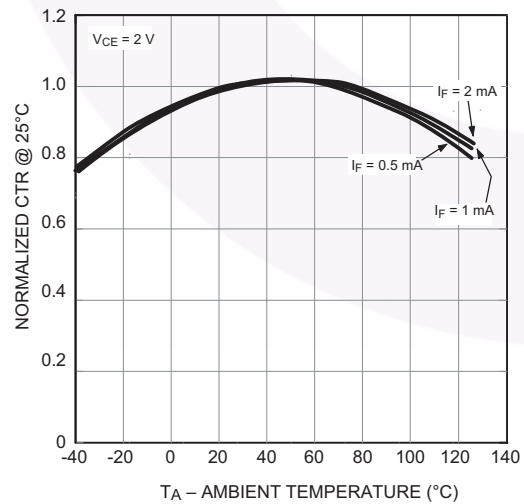

Figure 7. Normalized CTR vs. Ambient Temperature

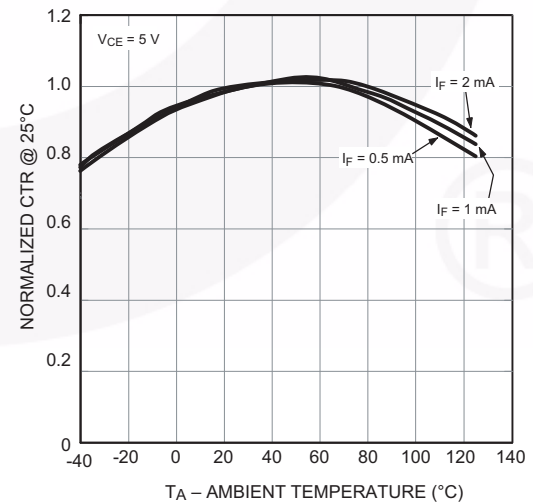

Figure 8. Normalized CTR vs. Ambient Temperature

Typical Performance Curves (Continued)

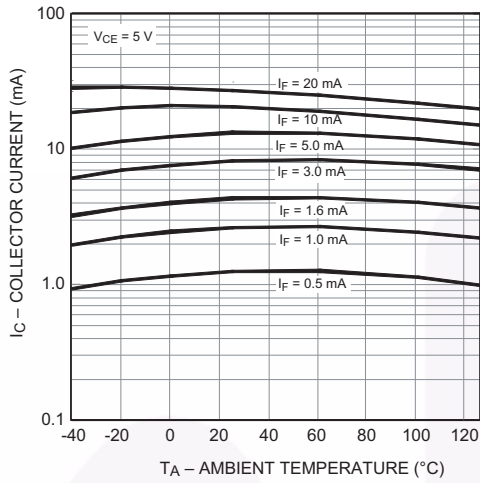

Figure 9. Collector Current vs. Ambient Temperature

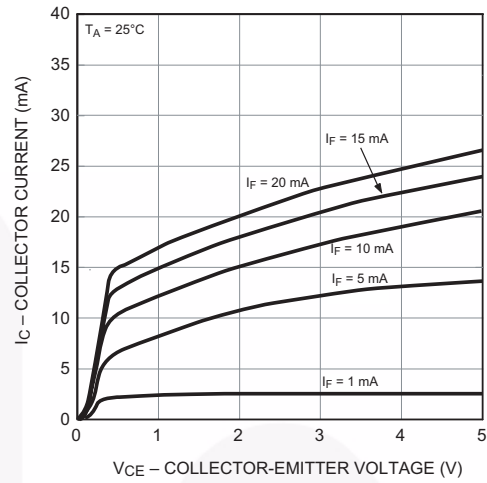

Figure 10 Collector Current vs. Collector-Emitter Voltage

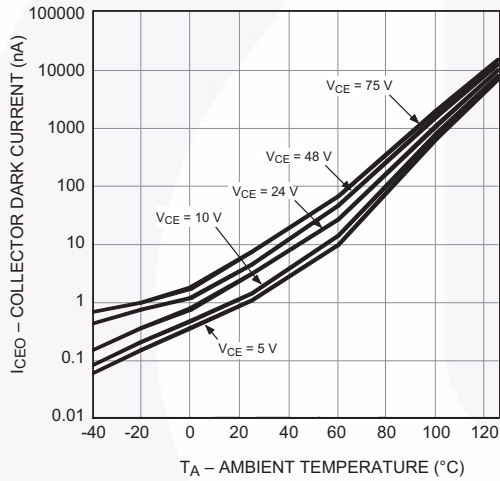

Figure 11. Collector Dark Current vs. Ambient Temperature

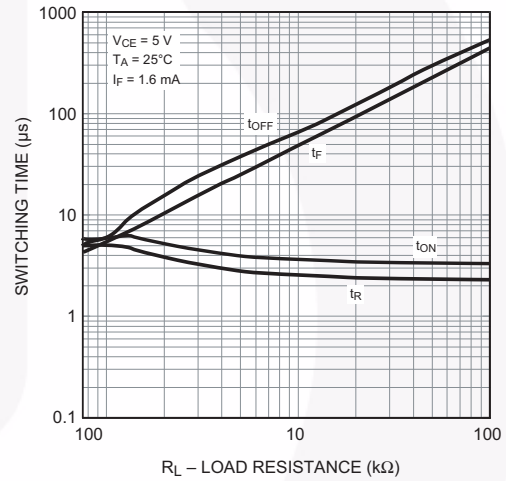

Figure 12. Switching Time vs. Load Resistance

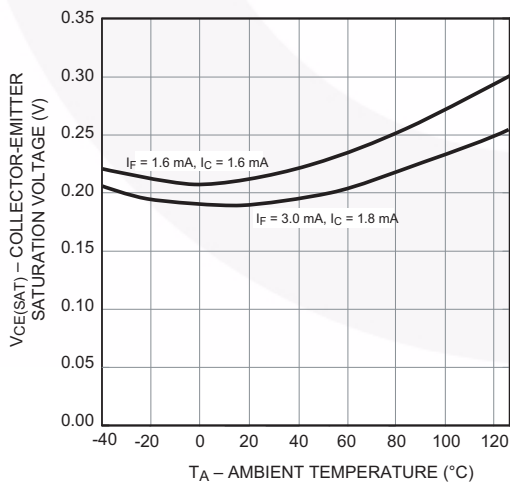

Figure 13. Collector-Emitter Saturation Voltage vs. Ambient Temperature

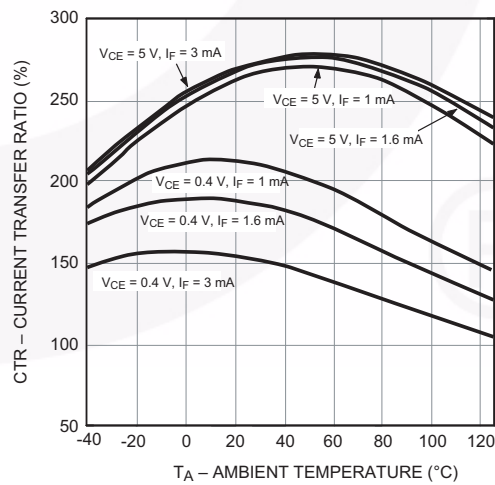

Figure 14. Current Transfer Ratio vs. Ambient Temperature

Test Circuits

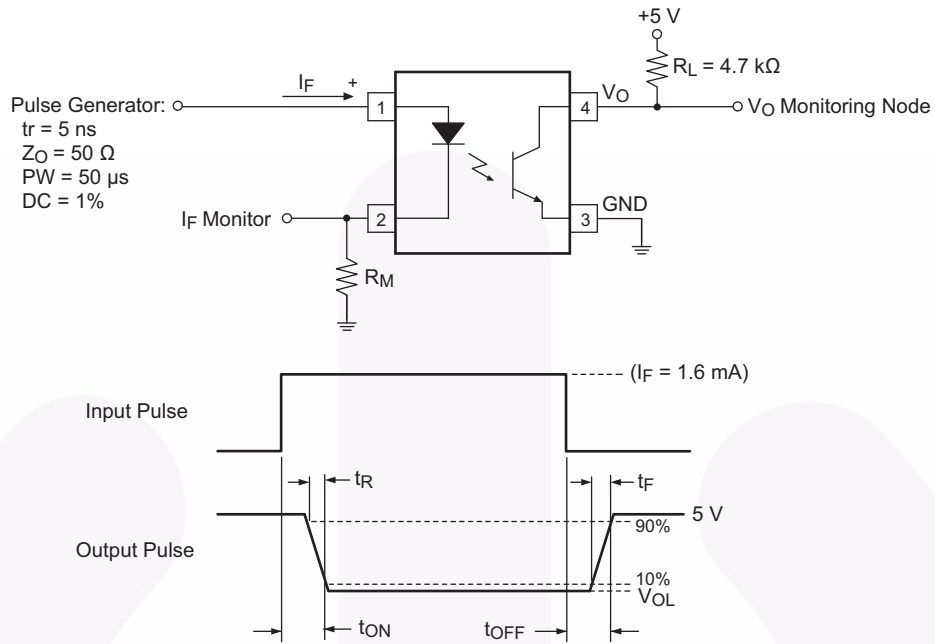

Figure 15. Test Circuit for Propagation Delay, Rise Time, and Fall Time

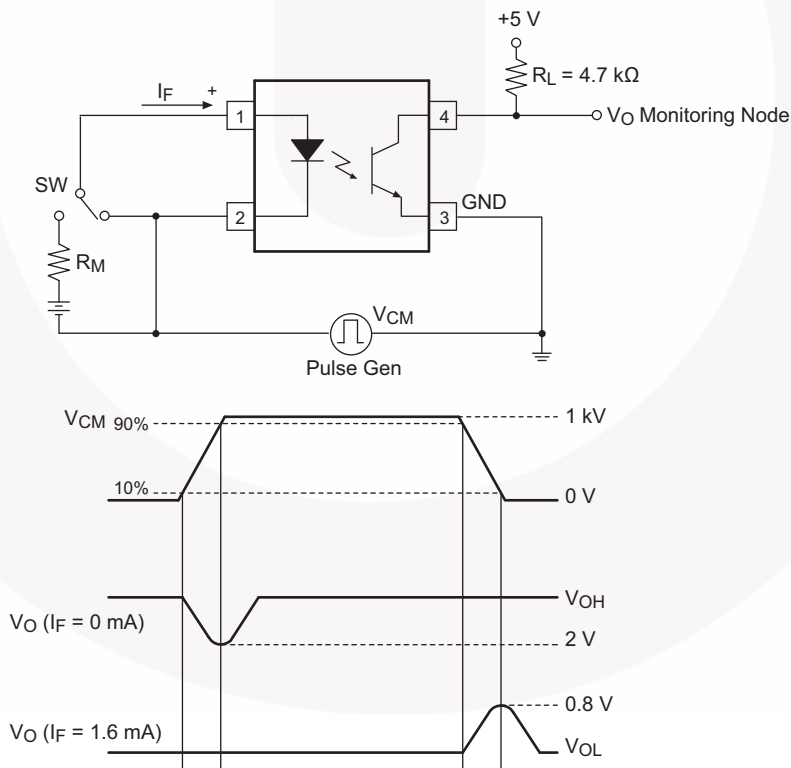
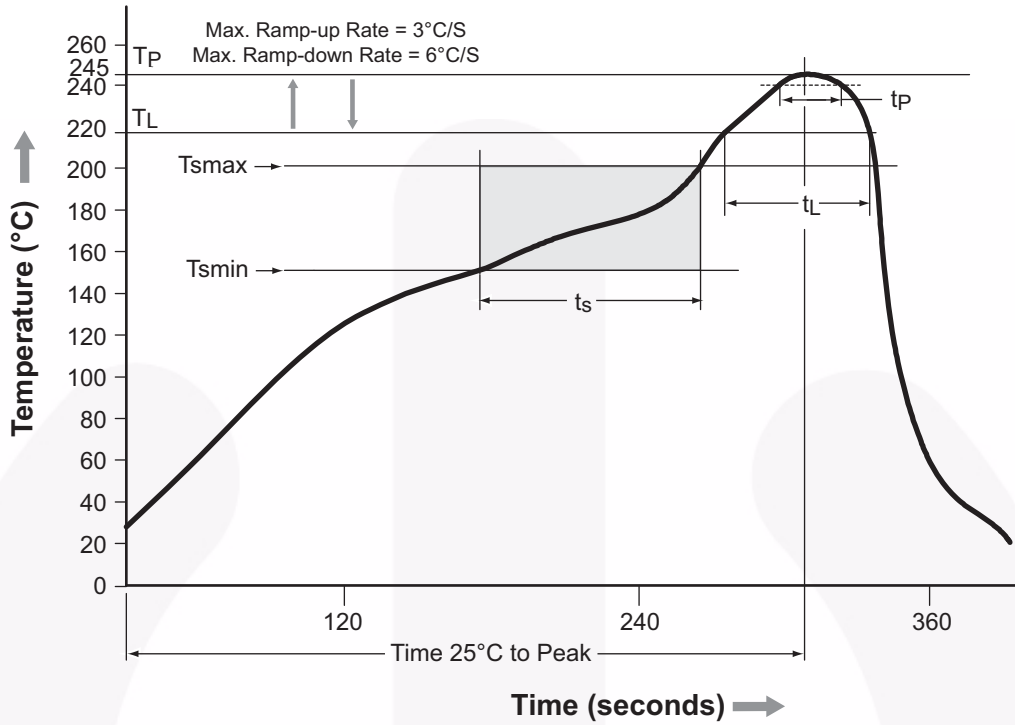

Figure 16. Test Circuit for Instantaneous Common-Mode Rejection Voltage

Reflow Profile



Profile Feature	Pb-Free Assembly Profile
Temperature Min. (T _{smin})	150°C
Temperature Max. (T _{smax})	200°C
Time (t _s) from (T _{smin} to T _{smax})	60–120 seconds
Ramp-up Rate (t _L to t _p)	3°C/second max.
Liquidous Temperature (T _L)	217°C
Time (t _L) Maintained Above (T _L)	60–150 seconds
Peak Body Package Temperature	245°C +0°C / –5°C
Time (t _p) within 5°C of 260°C	30 seconds
Ramp-down Rate (T _P to T _L)	6°C/second max.
Time 25°C to Peak Temperature	8 minutes max.

Figure 17. Reflow Profile

Ordering Information

Part Number	Package	Packing Method
FODM8801A	Half Pitch Mini-Flat 4-Pin	Tube (100 units)
FODM8801AR2	Half Pitch Mini-Flat 4-Pin	Tape and Reel (2500 Units)
FODM8801AV	Half Pitch Mini-Flat 4-Pin, DIN EN/IEC60747-5-5 Option	Tube (100 Units)
FODM8801AR2V	Half Pitch Mini-Flat 4-Pin, DIN EN/IEC60747-5-5 Option	Tape and Reel (2500 Units)

Note:

8. The product orderable part number system listed in this table also applies to the FODM8801B, FODM8801C products.

Marking Information

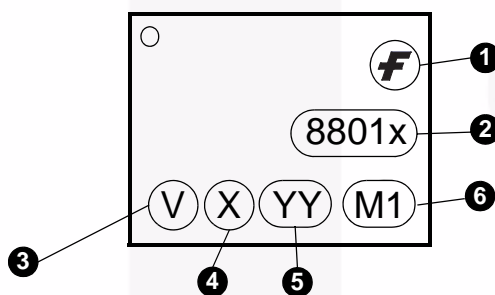
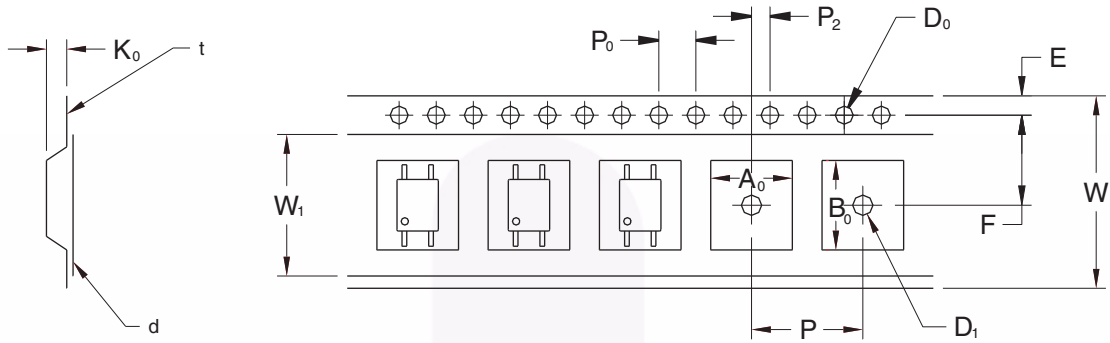

Figure 18. Top Mark

Table 1. Top Mark Definitions

1	Fairchild Logo
2	Device Number
3	DIN EN/IEC60747-5-5 Option (only appears on component ordered with this option)
4	One-Digit Year Code, e.g., “6”
5	Digit Work Week, Ranging from “01” to “53”
6	Assembly Package Code

Tape and Reel Dimensions



		1.27 Pitch
Description	Symbol	Dimensions (mm)
Tape Width	W	12.00 +0.30/-0.10
Tape Thickness	t	0.30 ±0.05
Sprocket Hole Pitch	P ₀	4.00 ±0.10
Sprocket Hole Diameter	D ₀	1.50 +0.10/-0.0
Sprocket Hole Location	E	1.75 ±0.10
Pocket Location	F	5.50 ±0.10
	P ₂	2.00 ±0.10
Pocket Pitch	P	8.00 ±0.10
Pocket Dimension	A ₀	2.80 ±0.10
	B ₀	7.30 ±0.10
	K ₀	2.30 ±0.10
Pocket Hole Diameter	D ₁	1.50 Min.
Cover Tape Width	W ₁	9.20
Cover Tape Thickness	d	0.065 ±0.010
Max. Component Rotation or Tilt		10° Max.
Devices Per Reel		2500
Reel Diameter		330 mm (13")

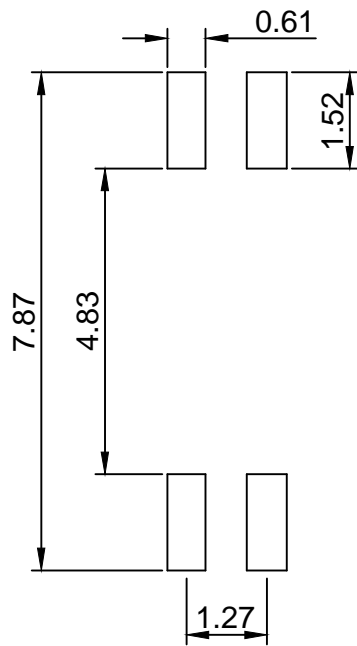
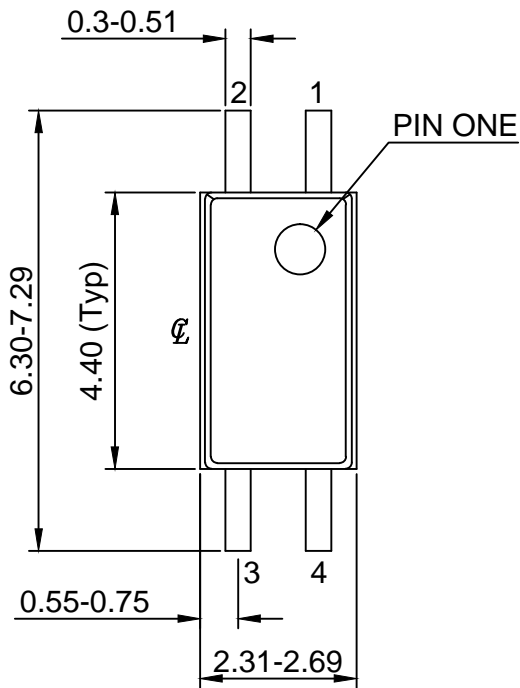

LAND PATTERN RECOMMENDATION

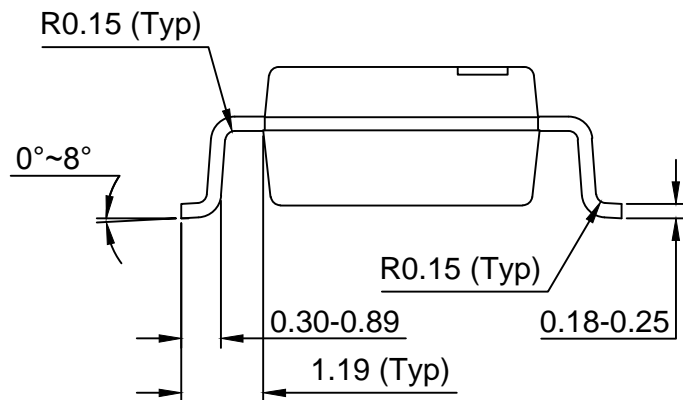
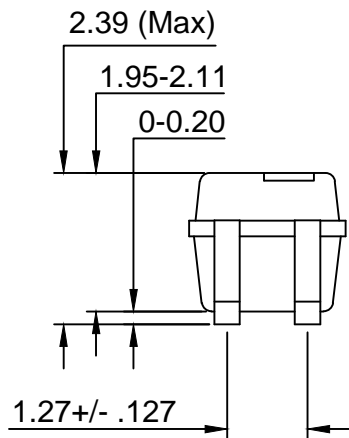

NOTES:

- A) NO STANDARD APPLIES TO THIS PACKAGE
- B) ALL DIMENSIONS ARE IN MILLIMETERS.
- C) DIMENSIONS ARE EXCLUSIVE OF BURRS, MOLD FLASH, AND TIE BAR EXTRUSION
- D) DRAWING FILENAME AND REVISION : MKT-MFP04AREV4.



ON Semiconductor and  are trademarks of Semiconductor Components Industries, LLC dba ON Semiconductor or its subsidiaries in the United States and/or other countries. ON Semiconductor owns the rights to a number of patents, trademarks, copyrights, trade secrets, and other intellectual property. A listing of ON Semiconductor's product/patent coverage may be accessed at www.onsemi.com/site/pdf/Patent-Marking.pdf. ON Semiconductor reserves the right to make changes without further notice to any products herein. ON Semiconductor makes no warranty, representation or guarantee regarding the suitability of its products for any particular purpose, nor does ON Semiconductor assume any liability arising out of the application or use of any product or circuit, and specifically disclaims any and all liability, including without limitation special, consequential or incidental damages. Buyer is responsible for its products and applications using ON Semiconductor products, including compliance with all laws, regulations and safety requirements or standards, regardless of any support or applications information provided by ON Semiconductor. "Typical" parameters which may be provided in ON Semiconductor data sheets and/or specifications can and do vary in different applications and actual performance may vary over time. All operating parameters, including "Typicals" must be validated for each customer application by customer's technical experts. ON Semiconductor does not convey any license under its patent rights nor the rights of others. ON Semiconductor products are not designed, intended, or authorized for use as a critical component in life support systems or any FDA Class 3 medical devices or medical devices with a same or similar classification in a foreign jurisdiction or any devices intended for implantation in the human body. Should Buyer purchase or use ON Semiconductor products for any such unintended or unauthorized application, Buyer shall indemnify and hold ON Semiconductor and its officers, employees, subsidiaries, affiliates, and distributors harmless against all claims, costs, damages, and expenses, and reasonable attorney fees arising out of, directly or indirectly, any claim of personal injury or death associated with such unintended or unauthorized use, even if such claim alleges that ON Semiconductor was negligent regarding the design or manufacture of the part. ON Semiconductor is an Equal Opportunity/Affirmative Action Employer. This literature is subject to all applicable copyright laws and is not for resale in any manner.

PUBLICATION ORDERING INFORMATION

LITERATURE FULFILLMENT:

Literature Distribution Center for ON Semiconductor
19521 E. 32nd Pkwy, Aurora, Colorado 80011 USA
Phone: 303-675-2175 or 800-344-3860 Toll Free USA/Canada
Fax: 303-675-2176 or 800-344-3867 Toll Free USA/Canada
Email: orderlit@onsemi.com

N. American Technical Support: 800-282-9855 Toll Free
USA/Canada
Europe, Middle East and Africa Technical Support:
Phone: 421 33 790 2910
Japan Customer Focus Center
Phone: 81-3-5817-1050

ON Semiconductor Website: www.onsemi.com
Order Literature: <http://www.onsemi.com/orderlit>
For additional information, please contact your local
Sales Representative