



Is Now Part of



**ON Semiconductor®**

To learn more about ON Semiconductor, please visit our website at  
[www.onsemi.com](http://www.onsemi.com)

ON Semiconductor and the ON Semiconductor logo are trademarks of Semiconductor Components Industries, LLC dba ON Semiconductor or its subsidiaries in the United States and/or other countries. ON Semiconductor owns the rights to a number of patents, trademarks, copyrights, trade secrets, and other intellectual property. A listing of ON Semiconductor's product/patent coverage may be accessed at [www.onsemi.com/site/pdf/Patent-Marking.pdf](http://www.onsemi.com/site/pdf/Patent-Marking.pdf). ON Semiconductor reserves the right to make changes without further notice to any products herein. ON Semiconductor makes no warranty, representation or guarantee regarding the suitability of its products for any particular purpose, nor does ON Semiconductor assume any liability arising out of the application or use of any product or circuit, and specifically disclaims any and all liability, including without limitation special, consequential or incidental damages. Buyer is responsible for its products and applications using ON Semiconductor products, including compliance with all laws, regulations and safety requirements or standards, regardless of any support or applications information provided by ON Semiconductor. "Typical" parameters which may be provided in ON Semiconductor data sheets and/or specifications can and do vary in different applications and actual performance may vary over time. All operating parameters, including "Typicals" must be validated for each customer application by customer's technical experts. ON Semiconductor does not convey any license under its patent rights nor the rights of others. ON Semiconductor products are not designed, intended, or authorized for use as a critical component in life support systems or any FDA Class 3 medical devices or medical devices with a same or similar classification in a foreign jurisdiction or any devices intended for implantation in the human body. Should Buyer purchase or use ON Semiconductor products for any such unintended or unauthorized application, Buyer shall indemnify and hold ON Semiconductor and its officers, employees, subsidiaries, affiliates, and distributors harmless against all claims, costs, damages, and expenses, and reasonable attorney fees arising out of, directly or indirectly, any claim of personal injury or death associated with such unintended or unauthorized use, even if such claim alleges that ON Semiconductor was negligent regarding the design or manufacture of the part. ON Semiconductor is an Equal Opportunity/Affirmative Action Employer. This literature is subject to all applicable copyright laws and is not for resale in any manner.



November 2015

# FOD814 Series, FOD817 Series 4-Pin DIP Phototransistor Optocouplers

## Features

- AC Input Response (FOD814)
- Current Transfer Ratio in Selected Groups:
  - FOD814: 20–300%
  - FOD817: 50–600%
  - FOD814A: 50–150%
  - FOD817A: 80–160%
  - FOD817B: 130–260%
  - FOD817C: 200–400%
  - FOD817D: 300–600%
- Minimum  $BV_{CEO}$  of 70 V Guaranteed
- Safety and Regulatory Approvals
  - UL1577, 5,000  $VAC_{RMS}$  for 1 Minute
  - DIN EN/IEC60747-5-5

## Applications

### FOD814 Series

- AC Line Monitor
- Unknown Polarity DC Sensor
- Telephone Line Interface

### FOD817 Series

- Power Supply Regulators
- Digital Logic Inputs
- Microprocessor Inputs

## Description

The FOD814 consists of two gallium arsenide infrared emitting diodes, connected in inverse parallel, driving a silicon phototransistor output in a 4-pin dual in-line package. The FOD817 Series consists of a gallium arsenide infrared emitting diode driving a silicon phototransistor in a 4-pin dual in-line package.

## Functional Block Diagram

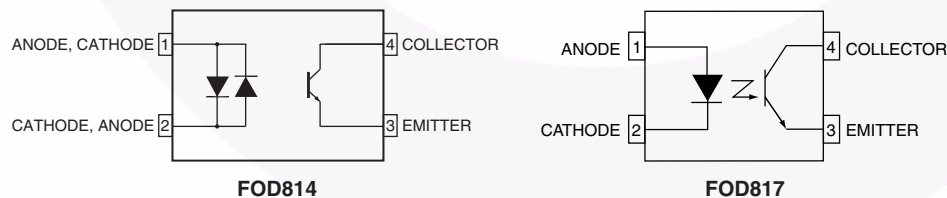


Figure 1. Schematic

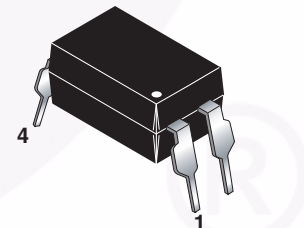


Figure 2. Package Outlines

## Safety and Insulation Ratings

As per DIN EN/IEC 60747-5-5, this optocoupler is suitable for “safe electrical insulation” only within the safety limit data. Compliance with the safety ratings shall be ensured by means of protective circuits.

Parameter		Characteristics
Installation Classifications per DIN VDE 0110/1.89 Table 1, For Rated Mains Voltage	< 150 V <sub>RMS</sub>	I–IV
	< 300 V <sub>RMS</sub>	I–III
Climatic Classification		30/110/21
Pollution Degree (DIN VDE 0110/1.89)		2
Comparative Tracking Index		175

Symbol	Parameter	Value	Unit
V <sub>PR</sub>	Input-to-Output Test Voltage, Method A, V <sub>IORM</sub> × 1.6 = V <sub>PR</sub> , Type and Sample Test with t <sub>m</sub> = 10 s, Partial Discharge < 5 pC	1360	V <sub>peak</sub>
	Input-to-Output Test Voltage, Method B, V <sub>IORM</sub> × 1.875 = V <sub>PR</sub> , 100% Production Test with t <sub>m</sub> = 1 s, Partial Discharge < 5 pC	1560	V <sub>peak</sub>
V <sub>IORM</sub>	Maximum Working Insulation Voltage	850	V <sub>peak</sub>
V <sub>IOTM</sub>	Highest Allowable Over-Voltage	8000	V <sub>peak</sub>
	External Creepage	≥ 7	mm
	External Clearance	≥ 7	mm
	External Clearance (for Option W, 0.4" Lead Spacing)	≥ 10	mm
DTI	Distance Through Insulation (Insulation Thickness)	≥ 0.4	mm
T <sub>S</sub>	Case Temperature <sup>(1)</sup>	175	°C
I <sub>S,INPUT</sub>	Input Current <sup>(1)</sup>	400	mA
P <sub>S,OUTPUT</sub>	Output Power <sup>(1)</sup>	700	mW
R <sub>IO</sub>	Insulation Resistance at T <sub>S</sub> , V <sub>IO</sub> = 500 V <sup>(1)</sup>	> 10 <sup>11</sup>	Ω

**Note:**

1. Safety limit values – maximum values allowed in the event of a failure.

## Absolute Maximum Ratings

Stresses exceeding the absolute maximum ratings may damage the device. The device may not function or be operable above the recommended operating conditions and stressing the parts to these levels is not recommended. In addition, extended exposure to stresses above the recommended operating conditions may affect device reliability. The absolute maximum ratings are stress ratings only.  $T_A = 25^\circ\text{C}$  Unless otherwise specified.

Symbol	Parameter	Value		Unit
		FOD814	FOD817	
<b>Total Device</b>				
$T_{STG}$	Storage Temperature	-55 to +150		$^\circ\text{C}$
$T_{OPR}$	Operating Temperature	-55 to +105	-55 to +110	$^\circ\text{C}$
$T_J$	Junction Temperature	-55 to +125		$^\circ\text{C}$
$T_{SOL}$	Lead Solder Temperature	260 for 10 seconds		$^\circ\text{C}$
$\theta_{JC}$	Junction-to-Case Thermal Resistance	210		$^\circ\text{C}/\text{W}$
$P_{TOT}$	Total Device Power Dissipation	200		mW
<b>EMITTER</b>				
$I_F$	Continuous Forward Current	$\pm 50$	50	mA
$V_R$	Reverse Voltage		6	V
$P_D$	Power Dissipation	70		mW
	Derate Above $100^\circ\text{C}$	1.7		mW/ $^\circ\text{C}$
<b>DETECTOR</b>				
$V_{CEO}$	Collector-Emitter Voltage	70		V
$V_{ECO}$	Emitter-Collector Voltage	6		V
$I_C$	Continuous Collector Current	50		mA
$P_C$	Collector Power Dissipation	150		mW
	Derate Above $90^\circ\text{C}$	2.9		mW/ $^\circ\text{C}$

## Electrical Characteristics

$T_A = 25^\circ\text{C}$  unless otherwise specified.

### Individual Component Characteristics

Symbol	Parameter	Device	Test Conditions	Min.	Typ.	Max.	Unit
<b>EMITTER</b>							
$V_F$	Forward Voltage	FOD814	$I_F = \pm 20\text{ mA}$		1.2	1.4	V
		FOD817	$I_F = 20\text{ mA}$		1.2	1.4	
$I_R$	Reverse Current	FOD817	$V_R = 4.0\text{ V}$			10	$\mu\text{A}$
$C_t$	Terminal Capacitance	FOD814	$V = 0, f = 1\text{ kHz}$		50	250	pF
		FOD817	$V = 0, f = 1\text{ kHz}$		30	250	
<b>DETECTOR</b>							
$I_{CEO}$	Collector Dark Current	FOD814	$V_{CE} = 20\text{ V}, I_F = 0$			100	nA
		FOD817	$V_{CE} = 20\text{ V}, I_F = 0$			100	
$BV_{CEO}$	Collector-Emitter Breakdown Voltage	FOD814	$I_C = 0.1\text{ mA}, I_F = 0$	70			V
		FOD817	$I_C = 0.1\text{ mA}, I_F = 0$	70			
$BV_{ECO}$	Emitter-Collector Breakdown Voltage	FOD814	$I_E = 10\text{ }\mu\text{A}, I_F = 0$	6			V
		FOD817	$I_E = 10\text{ }\mu\text{A}, I_F = 0$	6			

### DC Transfer Characteristics

Symbol	Parameter	Device	Test Conditions	Min.	Typ.	Max.	Unit
CTR	Current Transfer Ratio <sup>(2)</sup>	FOD814	$I_F = \pm 1\text{ mA}, V_{CE} = 5\text{ V}$	20		300	%
		FOD814A		50		150	
		FOD817	$I_F = 5\text{ mA}, V_{CE} = 5\text{ V}$	50		600	
		FOD817A		80		160	
		FOD817B		130		260	
		FOD817C		200		400	
		FOD817D		300		600	
$V_{CE(SAT)}$	Collector-Emitter Saturation Voltage	FOD814	$I_F = \pm 20\text{ mA}, I_C = 1\text{ mA}$		0.1	0.2	V
		FOD817	$I_F = 20\text{ mA}, I_C = 1\text{ mA}$		0.1	0.2	

### AC Transfer Characteristics

Symbol	Parameter	Device	Test Conditions	Min.	Typ.	Max.	Unit
$f_C$	Cut-Off Frequency	FOD814	$V_{CE} = 5\text{ V}, I_C = 2\text{ mA}, R_L = 100\text{ }\Omega, -3\text{ dB}$	15	80		kHz
$t_r$	Response Time (Rise)	FOD814, FOD817	$V_{CE} = 2\text{ V}, I_C = 2\text{ mA}, R_L = 100\text{ }\Omega^{(3)}$		4	18	$\mu\text{s}$
$t_f$	Response Time (Fall)	FOD814, FOD817			3	18	$\mu\text{s}$

#### Notes:

- Current Transfer Ratio (CTR) =  $I_C / I_F \times 100\%$ .
- For test circuit setup and waveforms, refer to page 7.

**Electrical Characteristics** (Continued) $T_A = 25^\circ\text{C}$  unless otherwise specified.**Isolation Characteristics**

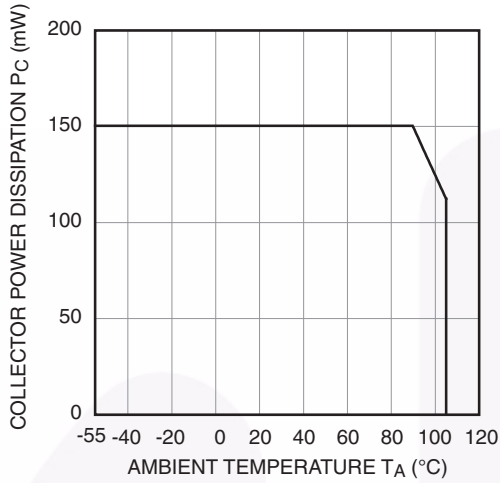
Symbol	Parameter	Device	Test Conditions	Min.	Typ.	Max.	Unit
$V_{\text{ISO}}$	Input-Output Isolation Voltage <sup>(4)</sup>	FOD814, FOD817	$f = 60 \text{ Hz}$ , $t = 1 \text{ minute}$ , $I_{\text{I-O}} \leq 2 \mu\text{A}$	5000			$\text{VAC}_{\text{RMS}}$
$R_{\text{ISO}}$	Isolation Resistance	FOD814, FOD817	$V_{\text{I-O}} = 500 \text{ V}_{\text{DC}}$	$5 \times 10^{10}$	$1 \times 10^{11}$		$\Omega$
$C_{\text{ISO}}$	Isolation Capacitance	FOD814, FOD817	$V_{\text{I-O}} = 0$ , $f = 1 \text{ MHz}$		0.6	1.0	pf

**Note:**

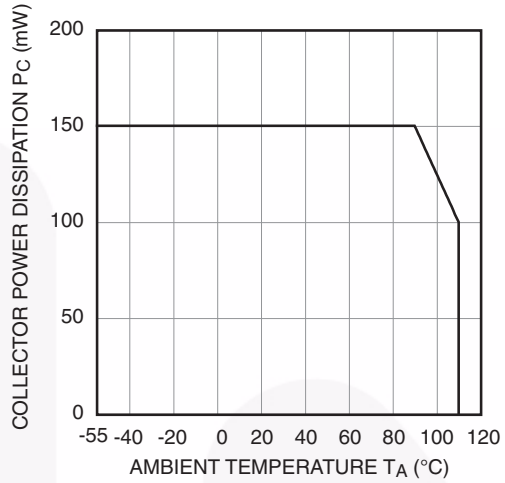
4. For this test, Pins 1 and 2 are common, and Pins 3 and 4 are common.

## Typical Electrical/Optical Characteristic Curves

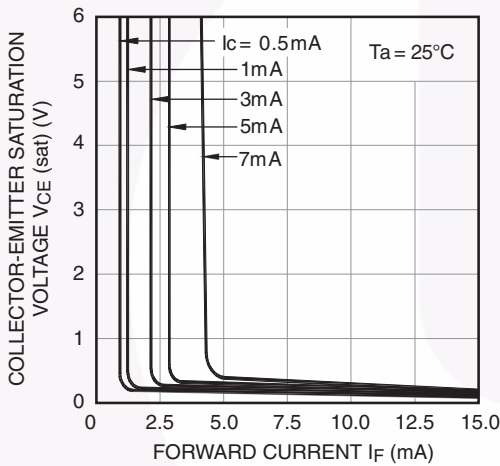
$T_A = 25^\circ\text{C}$  unless otherwise specified.



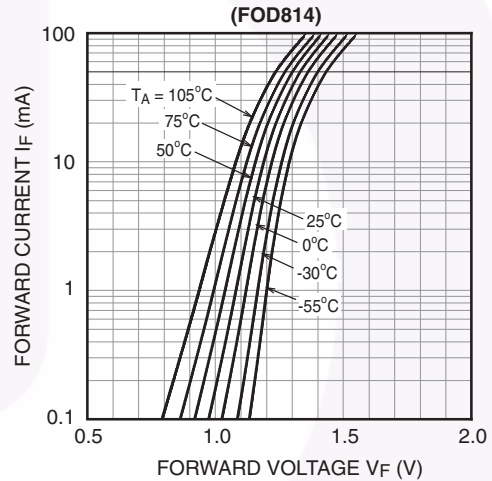
**Fig. 3 Collector Power Dissipation vs. Ambient Temperature (FOD814)**



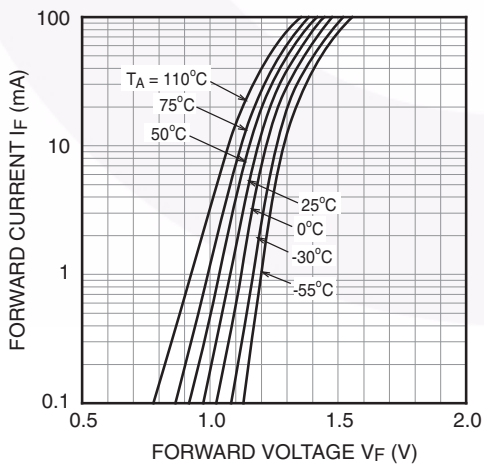
**Fig. 4 Collector Power Dissipation vs. Ambient Temperature (FOD817)**



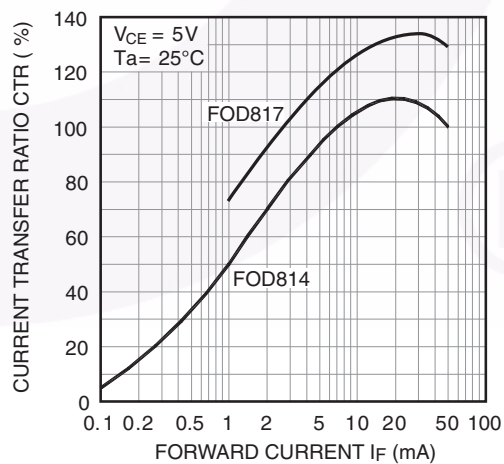
**Fig. 5 Collector-Emitter Saturation Voltage vs. Forward Current**



**Fig. 6 Forward Current vs. Forward Voltage**



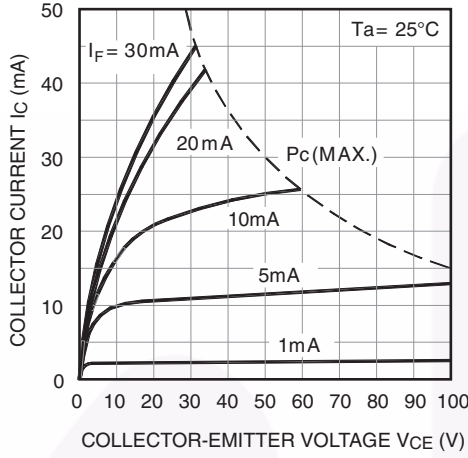
**Fig. 7 Forward Current vs. Forward Voltage (FOD817)**



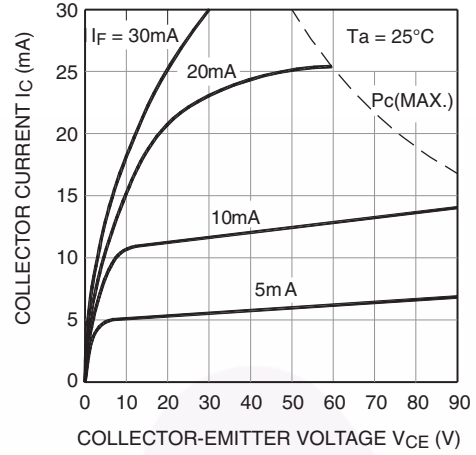
**Fig. 8 Current Transfer Ratio vs. Forward Current**

**Typical Electrical/Optical Characteristic Curves (Continued)**

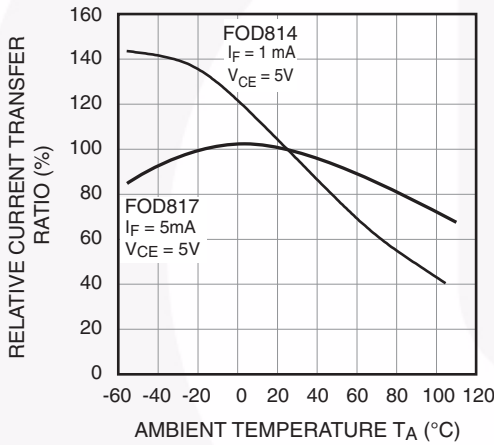
$T_A = 25^\circ\text{C}$  unless otherwise specified.



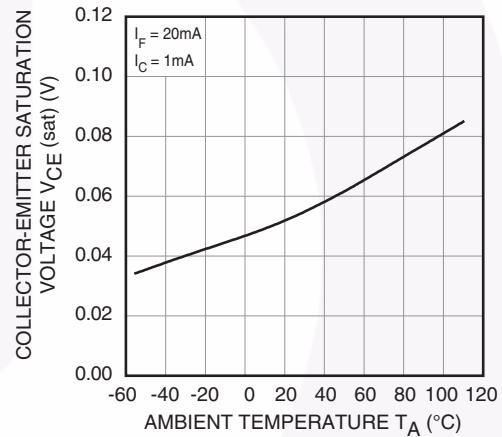
**Fig. 9 Collector Current vs. Collector-Emitter Voltage (FOD814)**



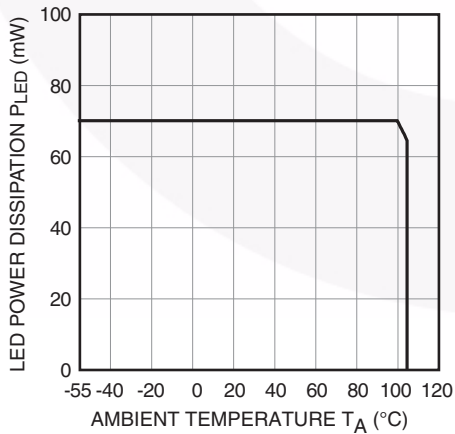
**Fig. 10 Collector Current vs. Collector-Emitter Voltage (FOD817)**



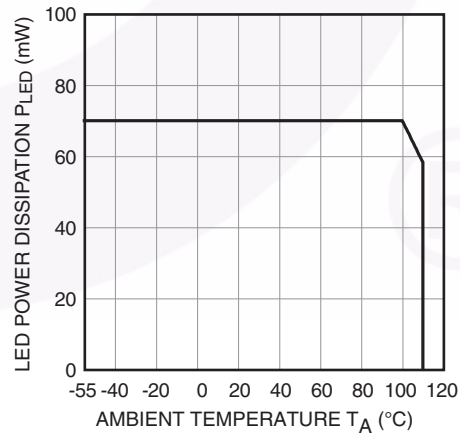
**Fig. 11 Relative Current Transfer Ratio vs. Ambient Temperature**



**Fig. 12 Collector-Emitter Saturation Voltage vs. Ambient Temperature**



**Fig. 13 LED Power Dissipation vs. Ambient Temperature (FOD814)**

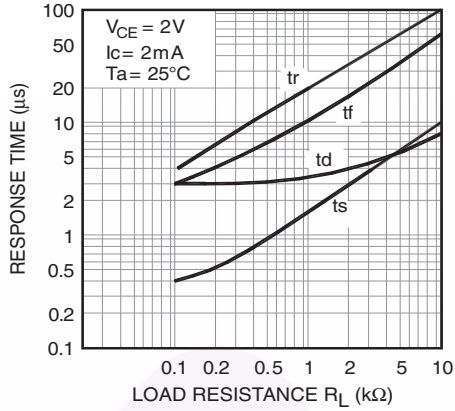


**Fig. 14 LED Power Dissipation vs. Ambient Temperature (FOD817)**

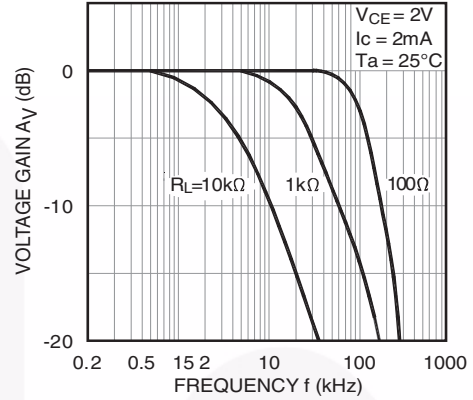


### Typical Electrical/Optical Characteristic Curves (Continued)

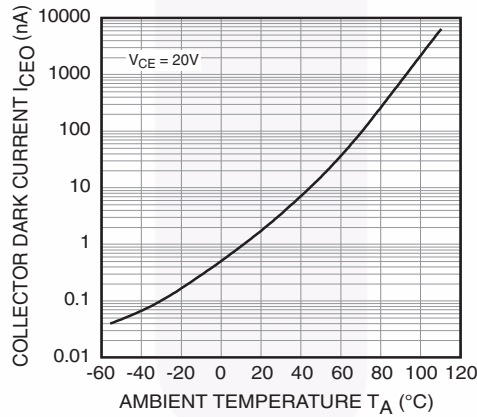
$T_A = 25^\circ\text{C}$  unless otherwise specified.



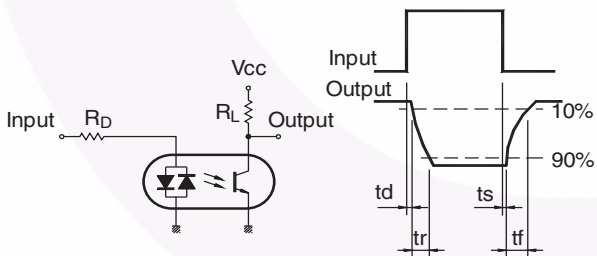
**Fig. 15 Response Time vs. Load Resistance**



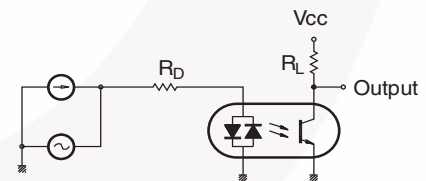
**Fig. 16 Frequency Response**



**Fig. 17 Collector Dark Current vs. Ambient Temperature**

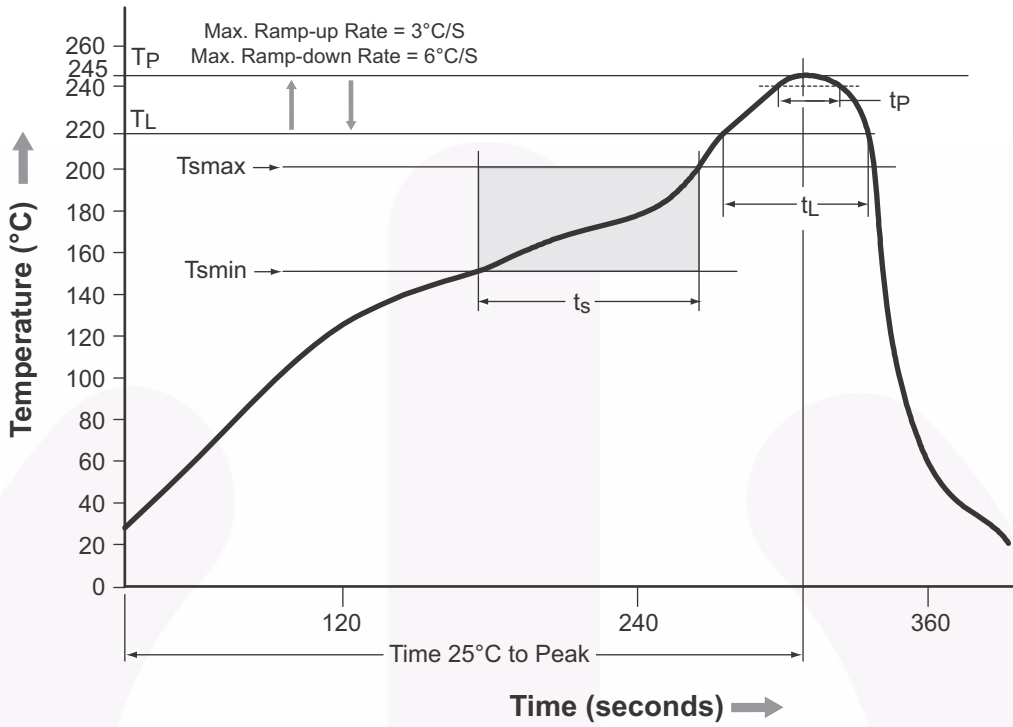


**Fig. 18 Test Circuit for Response Time**



**Fig. 19 Test Circuit for Frequency Response**

### Reflow Profile



Profile Feature	Pb-Free Assembly Profile
Temperature Min. (T <sub>min</sub> )	150°C
Temperature Max. (T <sub>max</sub> )	200°C
Time (t <sub>s</sub> ) from (T <sub>min</sub> to T <sub>max</sub> )	60–120 seconds
Ramp-up Rate (t <sub>L</sub> to t <sub>p</sub> )	3°C/second max.
Liquidous Temperature (T <sub>L</sub> )	217°C
Time (t <sub>L</sub> ) Maintained Above (T <sub>L</sub> )	60–150 seconds
Peak Body Package Temperature	245°C +0°C / -5°C
Time (t <sub>p</sub> ) within 5°C of 260°C	30 seconds
Ramp-down Rate (T <sub>p</sub> to T <sub>L</sub> )	6°C/second max.
Time 25°C to Peak Temperature	8 minutes max.

Figure 20. Reflow Profile

## Ordering Information

Part Number	Package	Packing Method
FOD817X	DIP 4-Pin	Tube (100 units per tube)
FOD817XS	SMT 4-Pin (Lead Bend)	Tube (100 units per tube)
FOD817XSD	SMT 4-Pin (Lead Bend)	Tape and Reel (1,000 units per reel)
FOD817X300	DIP 4-Pin, DIN EN/IEC60747-5-5 option	Tube (100 units per tube)
FOD817X3S	SMT 4-Pin (Lead Bend), DIN EN/IEC60747-5-5 option	Tube (100 units per tube)
FOD817X3SD	SMT 4-Pin (Lead Bend), DIN EN/IEC60747-5-5 option	Tape and Reel (1,000 units per reel)
FOD817X300W	DIP 4-Pin, 0.4" Lead Spacing, DIN EN/IEC60747-5-5 option	Tube (100 units per tube)

### Note:

The product orderable part number system listed in this table also applies to the FOD814 products.

"X" denotes the Current Transfer Ratio (CTR) options

## Marking Information

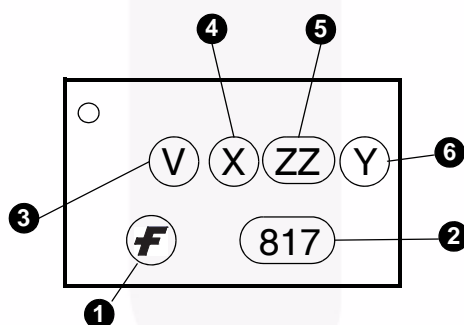


Figure 21. Top Mark

Definitions	
1	Fairchild Logo
2	Device Number
3	DIN EN/IEC60747-5-5 Option (only appears on parts ordered with this option)
4	One-Digit Year Code, e.g., '5'
5	Two-Digit Work Week, Ranging from '01' to '53'
6	Assembly Package Code Y = Manufactured in Thailand YA = Manufactured in China

### Carrier Tape Specifications

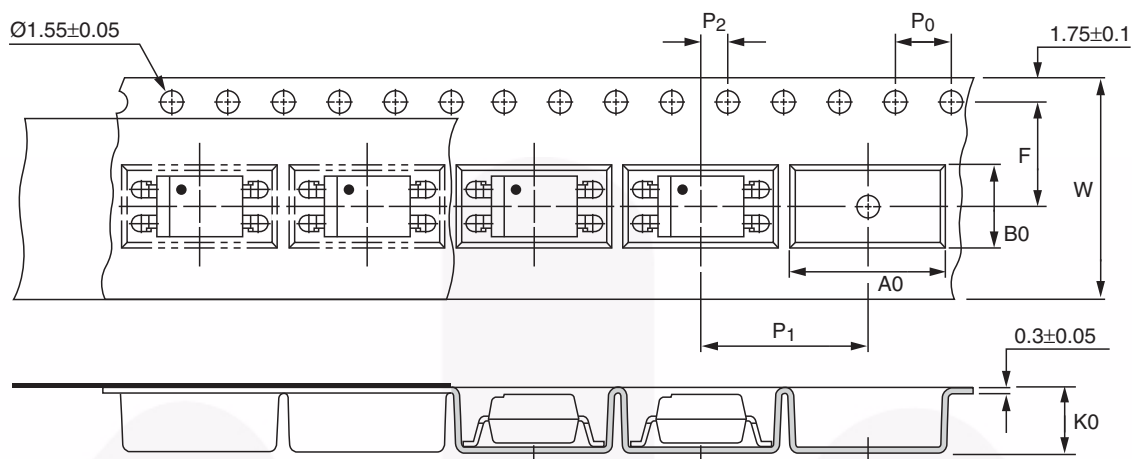
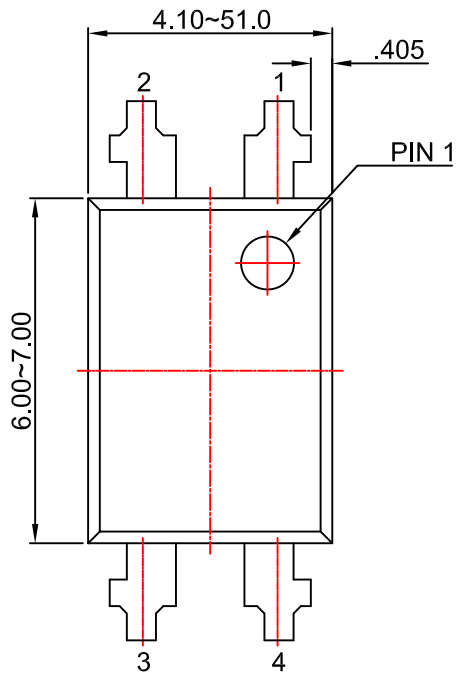


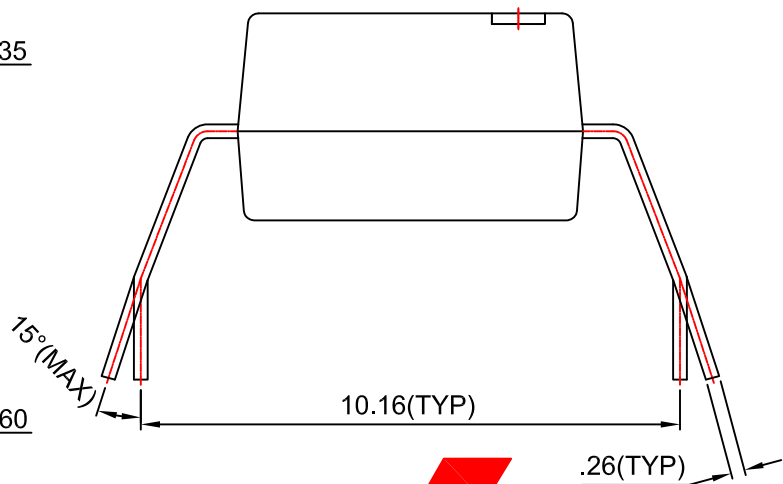
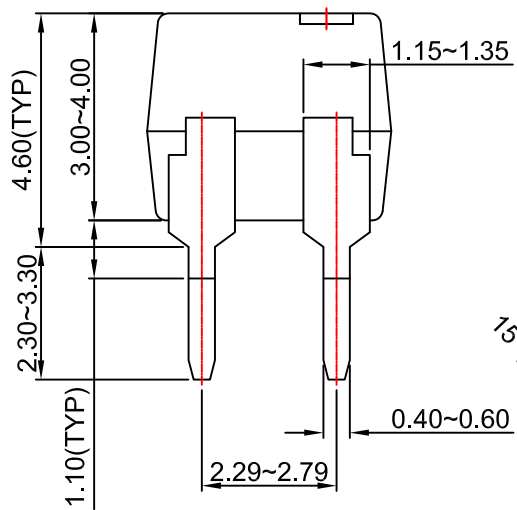
Figure 22. Carrier Tape Specification

Symbol	Description	Dimensions in mm (inches)
W	Tape wide	16 ± 0.3 (0.63)
P <sub>0</sub>	Pitch of sprocket holes	4 ± 0.1 (0.15)
F	Distance of compartment	7.5 ± 0.1 (0.295)
P <sub>2</sub>		2 ± 0.1 (0.079)
P <sub>1</sub>	Distance of compartment to compartment	12 ± 0.1 (0.472)
A <sub>0</sub>	Compartment	10.45 ± 0.1 (0.411)
B <sub>0</sub>		5.30 ± 0.1 (0.209)
K <sub>0</sub>		4.25 ± 0.1 (0.167)

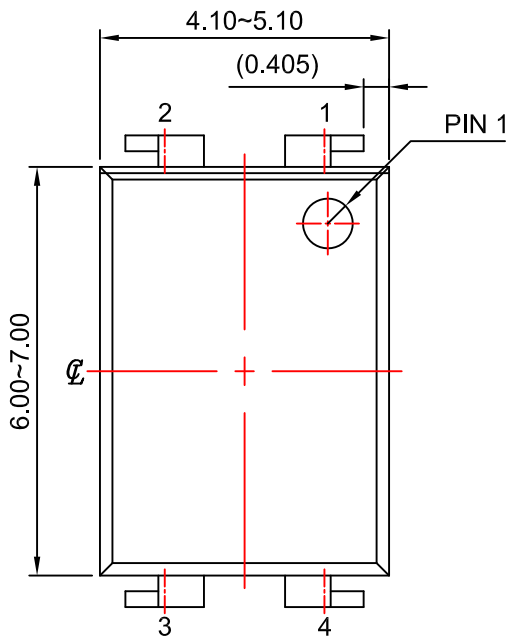


NOTES:

- A) NO STANDARD APPLIES TO THIS PACKAGE.
- B) ALL DIMENSIONS ARE IN MILLIMETERS.
- C) DIMENSIONS ARE EXCLUSIVE OF BURRS, MOLD FLASH, AND TIE BAR EXTRUSION
- D) DRAWING FILENAME AND REVISION: MKT-N04Brev2.

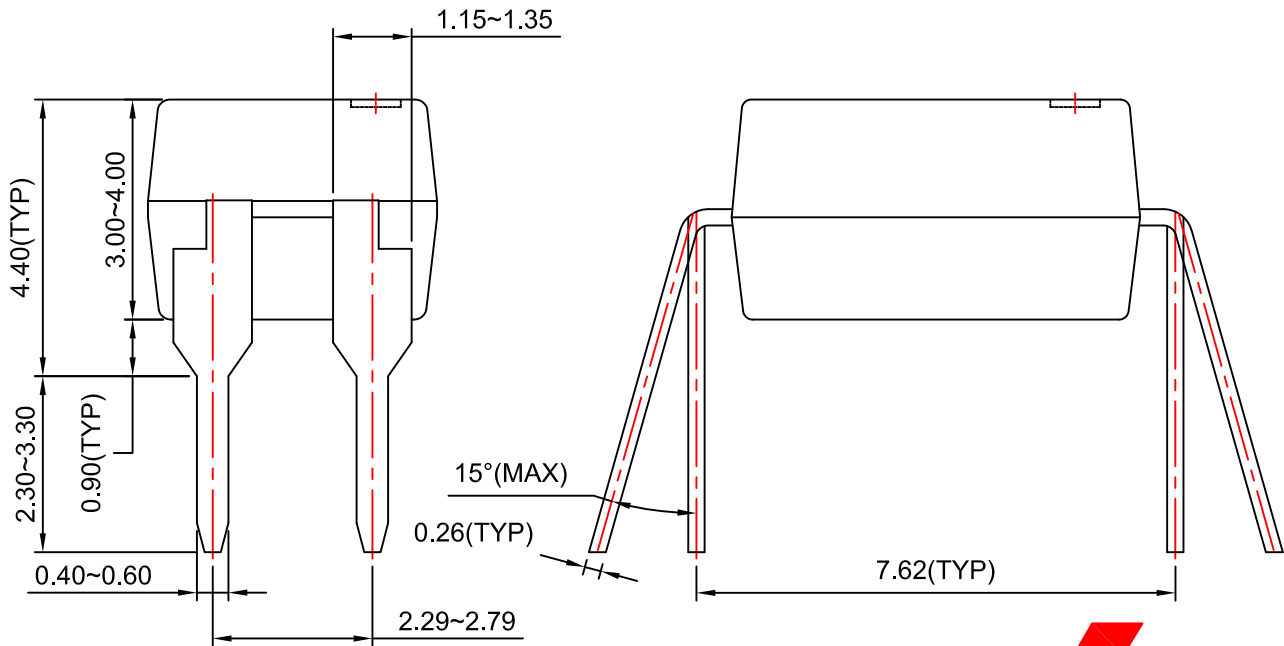






NOTES:

- A) NO STANDARD APPLIES TO THIS PACKAGE.
- B) ALL DIMENSIONS ARE IN MILLIMETERS.
- C) DIMENSIONS ARE EXCLUSIVE OF BURRS, MOLD FLASH, AND TIE BAR EXTRUSION
- D) DRAWING FILENAME AND REVISION: MKT-N04Arev2.



ON Semiconductor and  are trademarks of Semiconductor Components Industries, LLC dba ON Semiconductor or its subsidiaries in the United States and/or other countries. ON Semiconductor owns the rights to a number of patents, trademarks, copyrights, trade secrets, and other intellectual property. A listing of ON Semiconductor's product/patent coverage may be accessed at [www.onsemi.com/site/pdf/Patent-Marking.pdf](http://www.onsemi.com/site/pdf/Patent-Marking.pdf). ON Semiconductor reserves the right to make changes without further notice to any products herein. ON Semiconductor makes no warranty, representation or guarantee regarding the suitability of its products for any particular purpose, nor does ON Semiconductor assume any liability arising out of the application or use of any product or circuit, and specifically disclaims any and all liability, including without limitation special, consequential or incidental damages. Buyer is responsible for its products and applications using ON Semiconductor products, including compliance with all laws, regulations and safety requirements or standards, regardless of any support or applications information provided by ON Semiconductor. "Typical" parameters which may be provided in ON Semiconductor data sheets and/or specifications can and do vary in different applications and actual performance may vary over time. All operating parameters, including "Typicals" must be validated for each customer application by customer's technical experts. ON Semiconductor does not convey any license under its patent rights nor the rights of others. ON Semiconductor products are not designed, intended, or authorized for use as a critical component in life support systems or any FDA Class 3 medical devices or medical devices with a same or similar classification in a foreign jurisdiction or any devices intended for implantation in the human body. Should Buyer purchase or use ON Semiconductor products for any such unintended or unauthorized application, Buyer shall indemnify and hold ON Semiconductor and its officers, employees, subsidiaries, affiliates, and distributors harmless against all claims, costs, damages, and expenses, and reasonable attorney fees arising out of, directly or indirectly, any claim of personal injury or death associated with such unintended or unauthorized use, even if such claim alleges that ON Semiconductor was negligent regarding the design or manufacture of the part. ON Semiconductor is an Equal Opportunity/Affirmative Action Employer. This literature is subject to all applicable copyright laws and is not for resale in any manner.

## PUBLICATION ORDERING INFORMATION

### LITERATURE FULFILLMENT:

Literature Distribution Center for ON Semiconductor  
19521 E. 32nd Pkwy, Aurora, Colorado 80011 USA  
**Phone:** 303-675-2175 or 800-344-3860 Toll Free USA/Canada  
**Fax:** 303-675-2176 or 800-344-3867 Toll Free USA/Canada  
**Email:** [orderlit@onsemi.com](mailto:orderlit@onsemi.com)

**N. American Technical Support:** 800-282-9855 Toll Free  
USA/Canada  
**Europe, Middle East and Africa Technical Support:**  
Phone: 421 33 790 2910  
**Japan Customer Focus Center**  
Phone: 81-3-5817-1050

**ON Semiconductor Website:** [www.onsemi.com](http://www.onsemi.com)  
**Order Literature:** <http://www.onsemi.com/orderlit>  
For additional information, please contact your local  
Sales Representative