

2-stage filter for 3-phase systems with neutral conductor

new



#### Description

- Terminals for three phases, neutral conductor and ground
- High symmetrical and asymmetrical attenuation
- In the frequency range from 10kHz up to 300MHz

#### Standards

- IEC 60939
- UL 1283, Edition 5, CSA 22.2 No. 8-M1986, @ Ta 75 °C

#### Approvals

- VDE Certificate Number: pending
- UL File Number: E72928

#### Applications

- Voltage rating 520 VAC for world wide acceptance
- Protection against interference voltage from the mains
- Especially designed for industrial applications such as: Frequency Converters, Stepper Motor Drives, UPS-Systems, Inverters

#### Weblinks

[pdf-datasheet](#), [html-datasheet](#), [General Product Information](#), [Approvals](#), [CE declaration of conformity](#), [RoHS](#), [CHINA-RoHS](#), [e-Shop](#), [SCHURTER-Stock-Check](#), [Distributor-Stock-Check](#), [Detailed request for product](#)

#### Technical Data

Rated Current	8 - 200 A
Rated voltage	300/520 VAC, 50/60 Hz
Approval for	8 - 200 A @ 50 (75) °C / 300/520 VAC; 50/60 Hz
Overload Current	1.5 x I <sub>r</sub>
Dielectric Strength	300/520 VAC: 2.25 kVDC between L-L 1.7 kVDC between L-N 2.75 kVDC between L-PE 2.75 kVDC between N-PE Test voltage 2 sec
Number of Filter Stages	2-stage
Weight	1.1 - 8.6 kg
Material: Housing	Metal
Sealing Compound	UL 94V-0

Mounting	Screw-on mounting on chassis
Terminal	Screw clamps
Operating Temperature [°C]	-25 °C to 100 °C
Climatic Category	25/100/21 acc. to IEC 60068-1
Degree of Protection	IP 20 acc. to IEC 60529
Protection Class	Suitable for appliances with protection class I acc. to IEC 61140
MTBF	> 200'000h acc. to MIL-HB-217 F

## Dimensions

### Case 2A

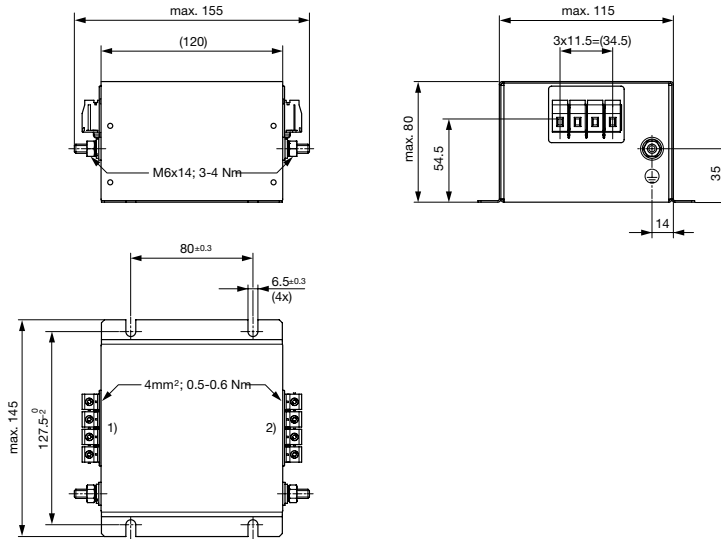

- 1) Line
- 2) Load

### Case 2B

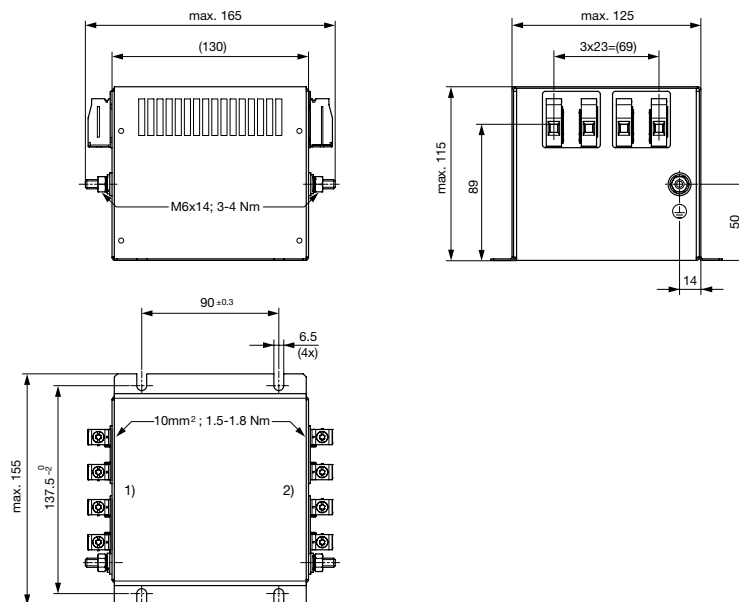

- 1) Line
- 2) Load

Case 2C

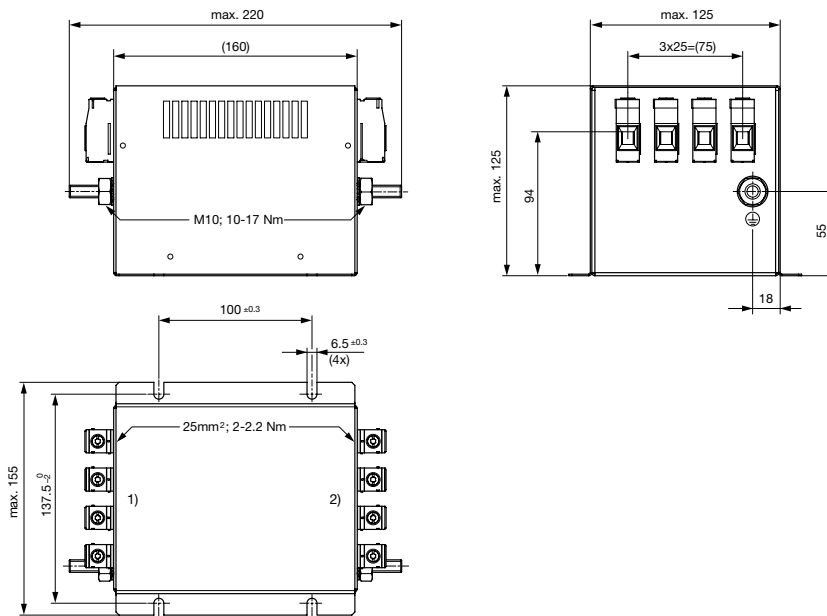

- 1) Line
- 2) Load

Case 2D

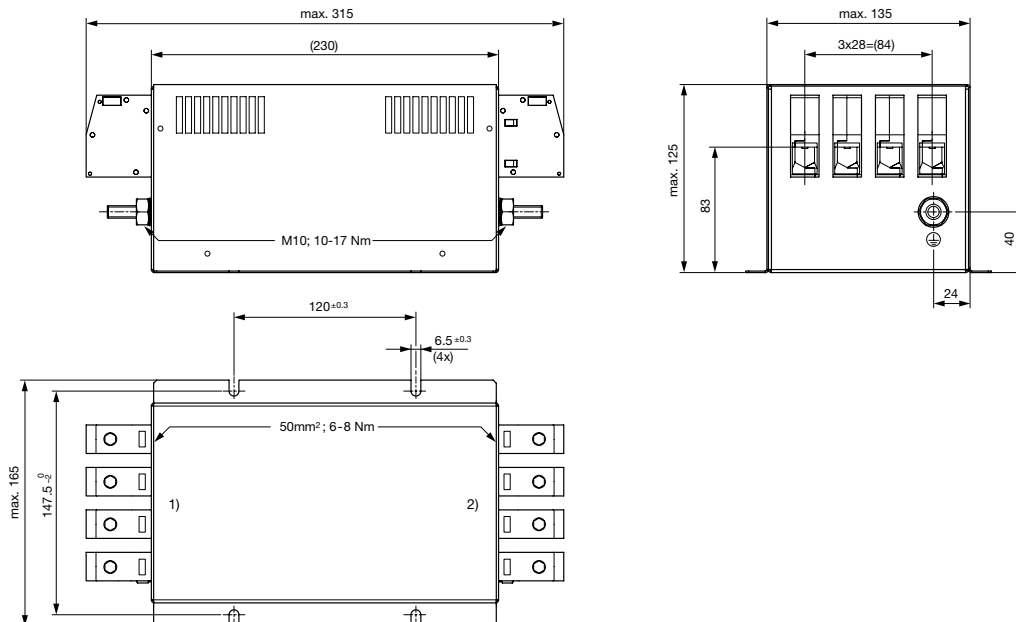

- 1) Line
- 2) Load

### Case 2E

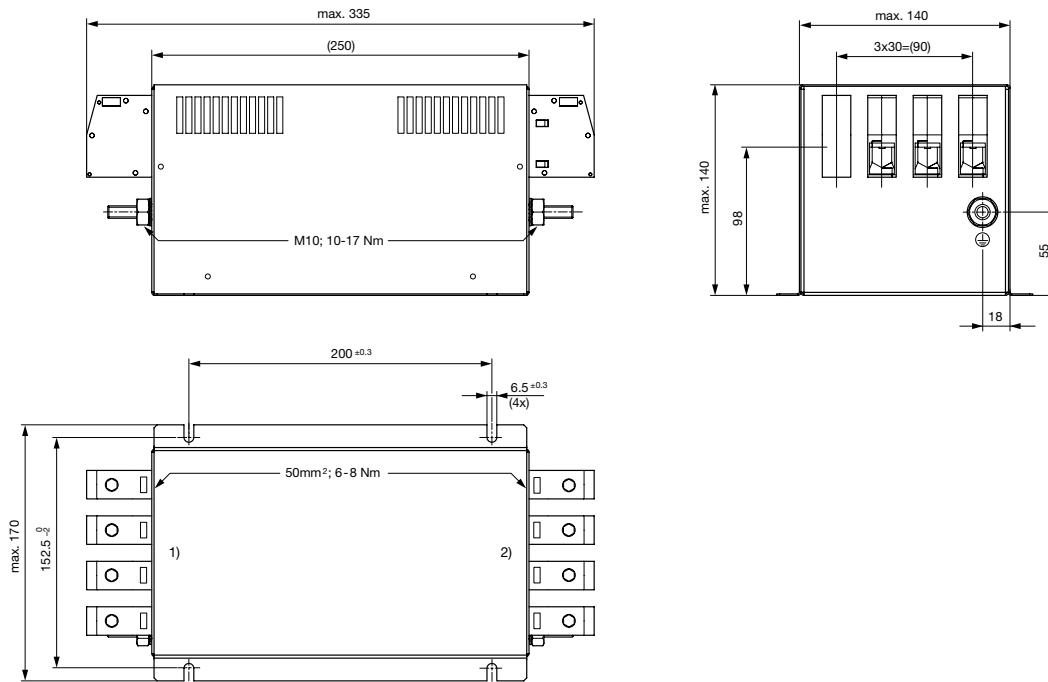

- 1) Line
- 2) Load

### Case 2F

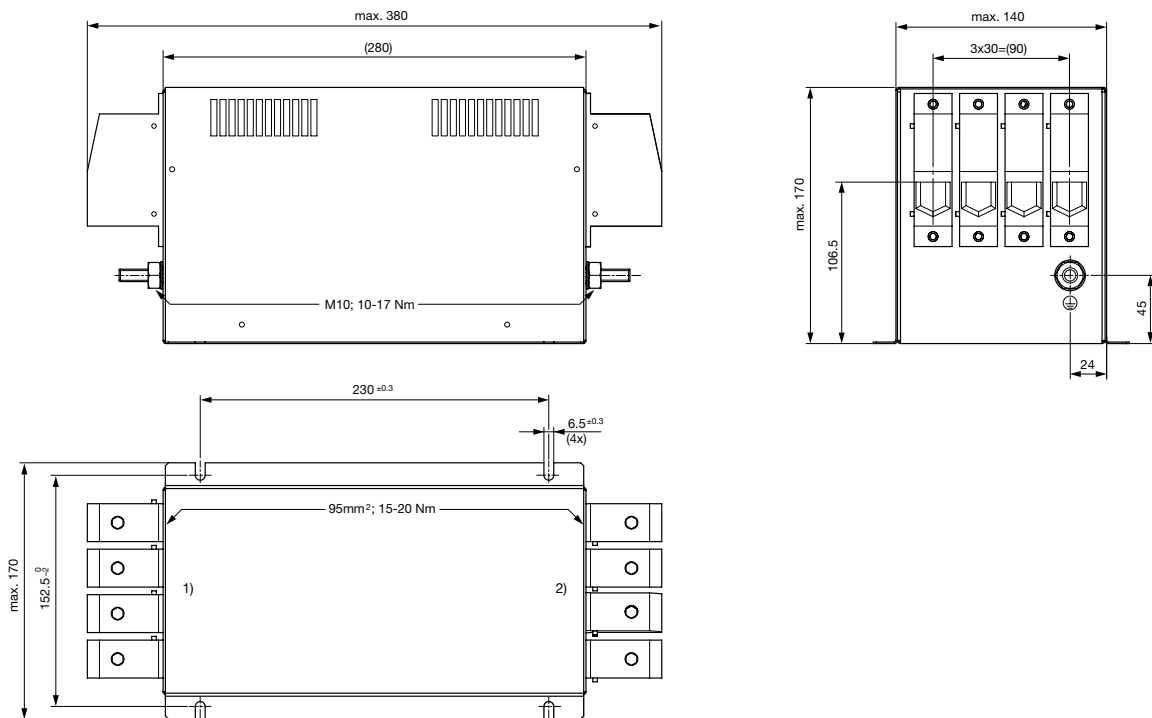

- 1) Line
- 2) Load

**Technical data to the filter components**

Rated Current @ Ta 50°C (75°C) [A]	L1 [mH]	L2 [μH]	C1 [μF]	C2 [μF]	C3 [μF]	R1 [MΩ]	R2 [MΩ]	R3 [MΩ]
8 (5)	2	4	2.2	2.2	3.4	-	1	2
16 (11)	1.3	12	2.2	2.2	3.4	-	1	2
25 (16)	1.6	12	4.7	4.7	3.4	1	1	2
36 (21)	1	12	4.7	4.7	3.4	1	1	2
64 (40)	0.7	7.5	4.7	4.7	3.4	1	1	2
80 (50)	0.6	9	8.2	8.2	3.4	1	1	2
120 (96)	0.6	9	13.6	13.6	3.4	0.5	0.5	2
160 (100)	0.4	9	13.6	13.6	3.4	0.5	0.5	2
200 (140)	0.3	9	13.6	13.6	3.4	0.5	0.5	2

**Diagrams**

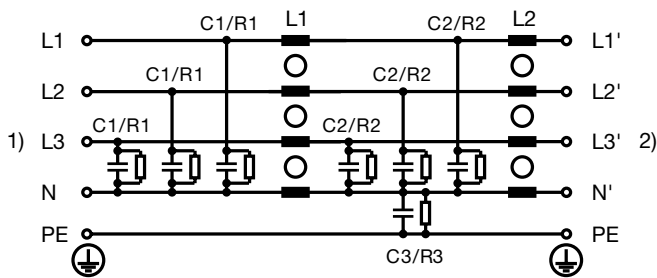

- 1) Line
- 2) Load

**Derating Curves**

Permissible Working Current as a Function of Ambient Temperature

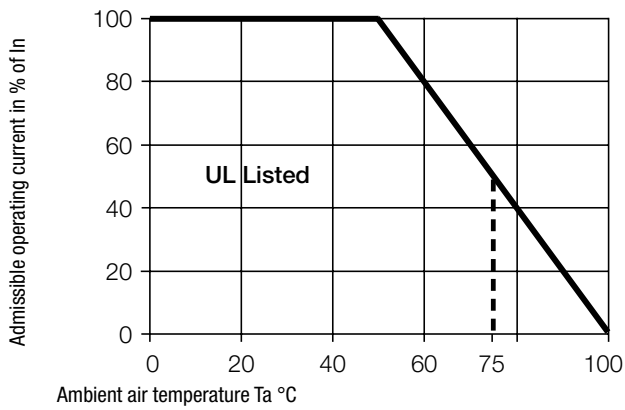

### Attenuation Loss

..... 0.1/100Ω differential mode ..... 100/0.1Ω differential mode - - - - differential mode \_\_\_\_ common mode

Industrial version

8 A

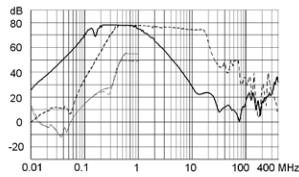

16A

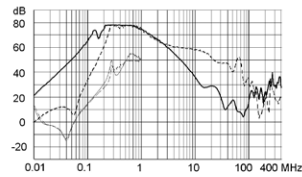

25A

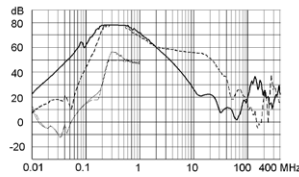

36A

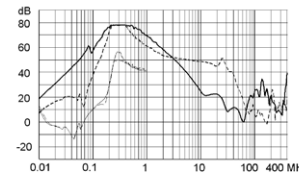

64A

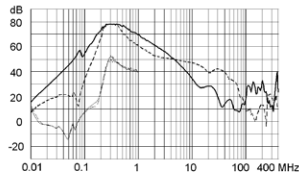

80A

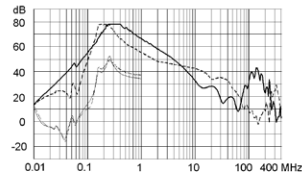

120A

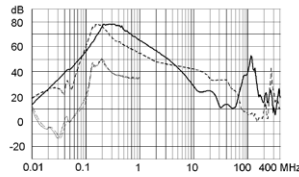

160A

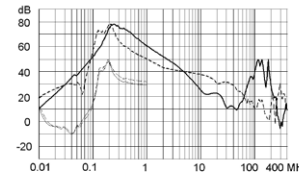

200A

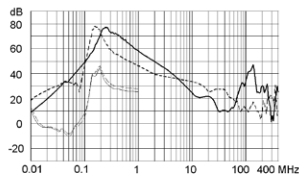

### Variants

Rated Current [A]	Tripped Power Dissipation [W]	Contact Resistance [mΩ]	Leakage Current [mA] <sup>1)</sup>	Weight [kg]	Screw clamps [mm <sup>2</sup> ] <sup>2)</sup>	Housing	Packaging unit [PCS]	Order Number
8 (5)	3.2	12.5	< 1	1.1 kg	4	2A	2	FMBD-B92A-0812
16 (11)	7	6.8	< 1	1.2 kg	4	2A	2	FMBD-B92A-1612
25 (16)	9.5	3.8	< 1	1.8 kg	10	2B	2	FMBD-B92B-2512
36 (21)	12.5	2.4	< 1	2 kg	10	2B	2	FMBD-B92B-3612
64 (40)	21.3	1.3	< 1	2.8 kg	25	2C	1	FMBD-B92C-6412
80 (50)	22.6	0.88	< 1	5.7 kg	50	2D	1	FMBD-B92D-8012
120 (96)	43.2	0.75	< 1	6.3 kg	50	2E	1	FMBD-B92E-J212
160 (100)	37.9	0.37	< 1	8 kg	95	2F	1	FMBD-B92F-J612
200 (140)	41.6	0.26	< 1	8.6 kg	95	2F	1	FMBD-B92F-K012

1) Maximum leakage current under normal operating conditions, assuming that all three phases and the neutral conductor are connected to the supply and the consumer. Under this condition, the current will mainly return through the neutral line, not as earth leakage.

2) Maximum conductor cross section (wire gauge) to be used; a comparative table for AWG and mm<sup>2</sup> values can be found in the general product information [www.schurter.com/emc\\_info](http://www.schurter.com/emc_info)