

0.3mm Pitch, 0.65mm Height, Top Contact, Back-Flip FPC Connectors

FH42 Series

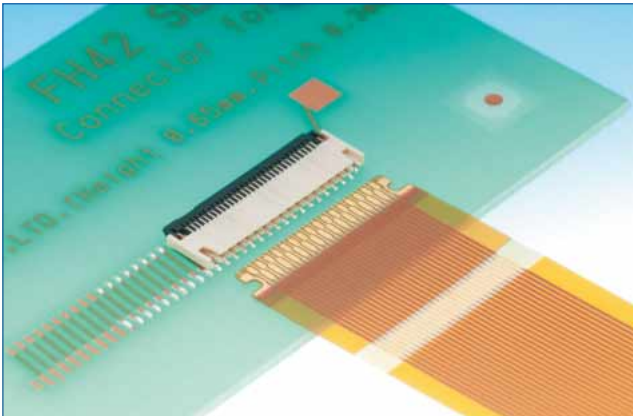

0.65mm height

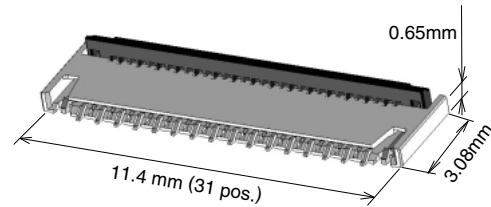

Fig.1

■ Features

1. Space saving 0.3mm pitch and low-profile top contact connector

This top contact connector delivers a 0.65mm height, mounting depth of 3.08mm and depth 3.55mm with the actuator closed. All of this helps to maximize PCB space.

2. FPC retention secured, despite the low profile

Improved FPC horizontal retention by reinforcing the clasp temporary retention mechanism.

3. Reduces production costs

The actuator is delivered in the open position and allows you to immediately insert the FPC.

4. Favorable FPC insertion, despite the low profile

- The unique clasp form means an audible click when the FPC goes over the clasp, while also preventing incorrect (diagonal) insertion of FPC.

- Despite the temporary retention mechanism of the reinforcing clasp, horizontal insertion of FPC is possible.

5. Insertion check window

There is a cutout on the housing that allows you to visually inspect the FPC to make sure that it is locked into place, preventing incorrect insertion of the FPC.

6. Accepts 0.12mm thick FPC

The connector accepts 0.12mm thick FPC, standard thickness for 0.3mm pitch low-profile connectors.

7. Fully molded structure aids PCB layout

The bottom of this connector is enclosed by a fully molded structure that protects the contacts and removes any restrictions from PCB patterning and layout design.

8. Halogen-free

The connector does not use chlorine and bromine exceeding standard limits.

Defined in accordance with IEC61249-2-21 Br : 900 ppm max, Cl : 900 ppm max, Br + Cl : 1,500 ppm max.

9. Supports automatic pick-n-place mounting

Offered in tape and reel packaging that is compatible with automatic machine mounting. (5,000 pieces per reel). The standard packaging is 5,000 pieces per reel, but it is also offered in a 500 piece reel. (The outer diameter of the reel will be ϕ 180mm in this case.)

FPC insertion

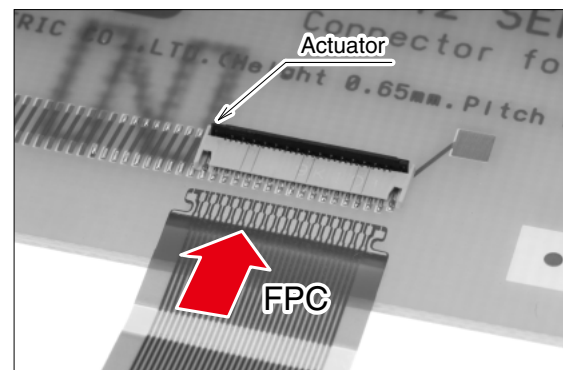

Fig.2

With actuator locked

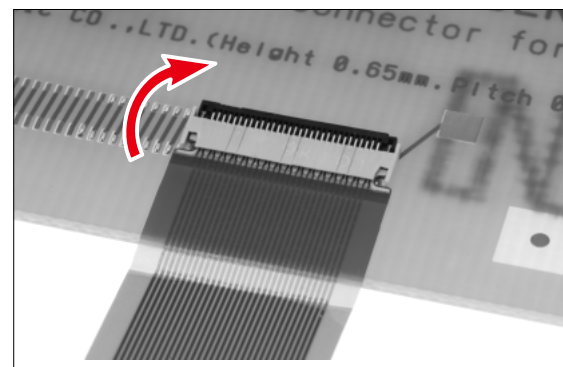
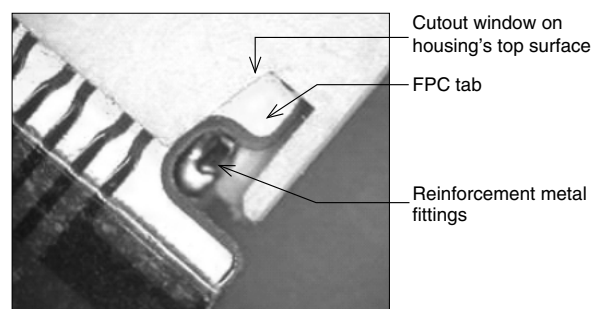

Fig.3



Product Specifications

Ratings	Current rating 0.2A (Note 1)	Operating temperature range : -55 to +85°C (Note 2)	Storage temperature range : -10 to +50°C (Note 3)
	Voltage rating 30Vrms AC	Operating humidity range : Relative humidity 90% max. (No condensation)	Storage humidity range : Relative humidity 90% max. (No condensation)

Recommended FPC SPC	t=0.12 ± 0.02mm, Gold plated
---------------------	------------------------------

Item	Specification	Conditions
1. Insulation resistance	50MΩ min.	100V DC
2. Withstanding voltage	No flashover or insulation breakdown	90Vrms AC / 1 minute
3. Contact resistance	200mΩ max. * Including FPC conductor resistance	1mA, AC max (AC : 1kHz)
4. Durability	Contact resistance : 200mΩ max. No damage, cracks and looseness of parts	10 cycles
5. Vibration	No electrical discontinuity of 1μs or longer Contact resistance : 200mΩ max. No damage, cracks and looseness of parts	Frequency : 10 to 55Hz, Half amplitude of 0.75mm, for 10 cycles in 3 axial directions
6. Shock	No electrical discontinuity of 1μs or longer Contact resistance : 200mΩ max. No damage, cracks and looseness of parts	981m/s ² , Duration of pulse 6ms at 3 times in 3 both axial directions
7. Humidity (Steady state)	Contact resistance : 200mΩ max. Insulation resistance : 50MΩ min. No damage, cracks and looseness of parts	96 hours at 40°C and humidity of 90 to 95%
8. Temperature cycle	Contact resistance : 200mΩ max. Insulation resistance : 50MΩ min. No damage, cracks and looseness of parts	Temperature : -55°C → +15°C to +35°C → +85°C → +15°C to +35°C Time : 30 → 2 to 3 → 30 → 2 to 3 minutes 5 cycles
9. Resistance to soldering heat	No deformation of case of excessive looseness of the terminal	Reflow : Recommended temperature profile Manual soldering : 350°C ±10°C for 5 seconds

Note 1 : When electrifying rated current to all contacts, use 70% of rated current.

Note 2 : Including temperature rise caused by current flow.

Note 3 : The term "storage" refers to the long-term storage condition of unused products before PCB mount.

Operating temperature and humidity ranges shall apply to unpowered products after PCB mount.

Materials / Finish

Parts	Material	Color/Finish	Remarks
Insulator	LCP	Beige	UL94V-0
	PA	Black	UL94HB
Contacts	Phosphor bronze	Gold plated	—
Metal fittings		Pure tin reflow plated	—

Product Number Structure

Refer to the chart below when determining the product specifications from the product number.

Please select from the product numbers listed in this catalog when placing orders.

FH 42 - 31S - 0.3 SHW (10)

① ② ③ ④ ⑤ ⑥

① Series name : FH	⑤ Terminal type SHW : SMT horizontal staggered mounting type
② Series No. : 42	
③ No. of contacts : 7, 9, 11, 15, 19, 23, 31, 39	⑥ Specifications (10) Gold plated with nickel barrier, 5,000 pieces per reel (99) Gold plated with nickel barrier, 500 pieces per reel
④ Contact pitch : 0.3mm	

Nov. 1. 2022 Copyright 2022 HIROSE ELECTRIC CO., LTD. All Rights Reserved.

Connector Dimensional Drawing

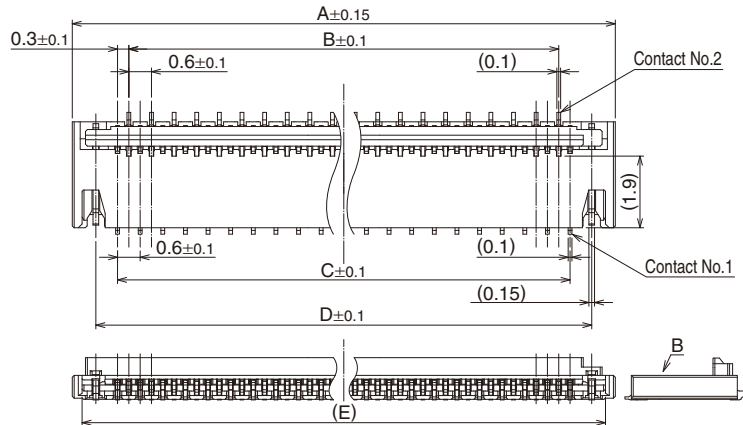

Detailed drawing of B

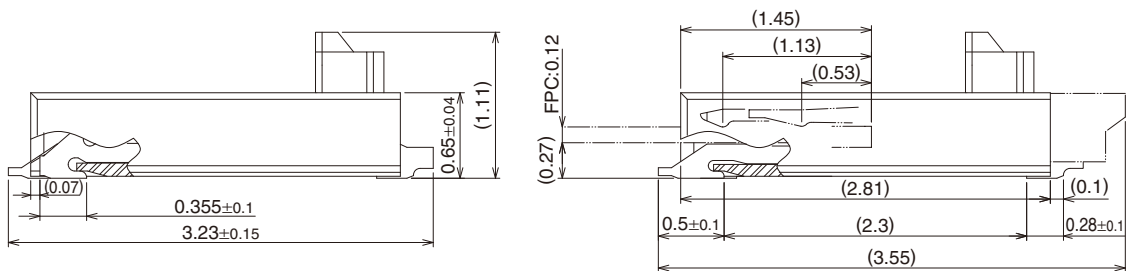

- Notes
1. The dimension in parentheses are for reference.
 2. Lead co-planarity including reinforced metal fittings shall be 0.1mm max.
 3. To be delivered with tape and reel packages, see attached packing specifications for details.
 4. Note that preventive hole for sink mark or slit could be added for improvement.
 5. The quality remains good, even with the dark spots, which could occasionally occur on molded plastic.
 6. The color of the plating may change after the reflow process, but it will not negatively affect the performance of these connectors.
 7. This product satisfies halogen-free requirements defined as 900ppm maximum chlorine, 900ppm maximum bromine, and 1500ppm maximum total of chlorine and bromine.

Unit : mm

Part No.	HRS No.	No. of Contacts	A	B	C	D	E
FH42-7S-0.3SHW(**)	580-2308-6 **	7	4.2	1.2	1.8	2.95	3.68
FH42-9S-0.3SHW(**)	580-2315-0 **	9	4.8	1.8	2.4	3.55	4.28
FH42-11S-0.3SHW(**)	580-2306-0 **	11	5.4	2.4	3	4.15	4.88
FH42-15S-0.3SHW(**)	580-2302-0 **	15	6.6	3.6	4.2	5.35	6.08
FH42-19S-0.3SHW(**)	580-2305-8 **	19	7.8	4.8	5.4	6.55	7.28
FH42-23S-0.3SHW(**)	580-2309-9 **	23	9	6	6.6	7.75	8.48
FH42-31S-0.3SHW(**)	580-2301-7 **	31	11.4	8.4	9	10.15	10.88
FH42-39S-0.3SHW(**)	580-2311-0 **	39	13.8	10.8	11.4	12.55	13.28

Note : This product is packaged on tape and reel and is only sold in full reel quantities of either 5,000 or 500 piece reels.
Please place orders by full reel quantities.

Recommended Land PCB Mounting Pattern

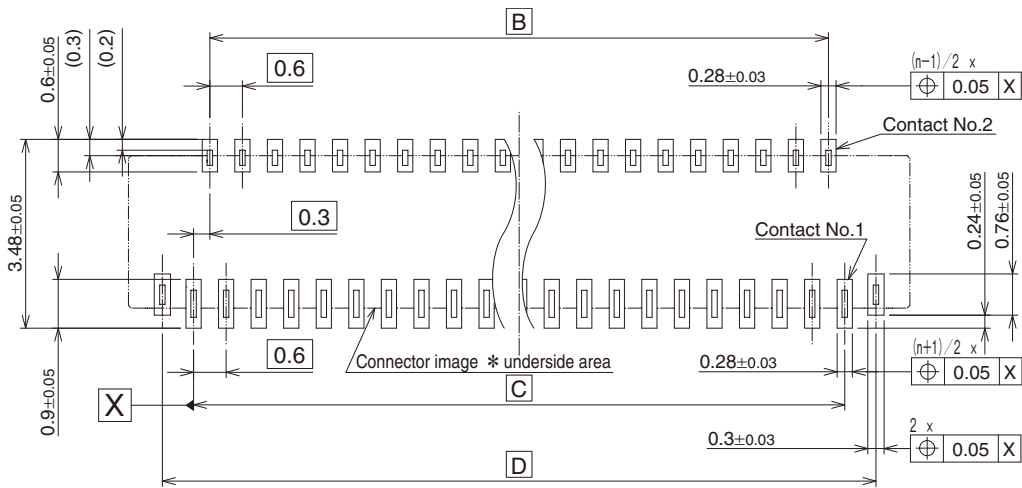

Recommended Stencil Pattern

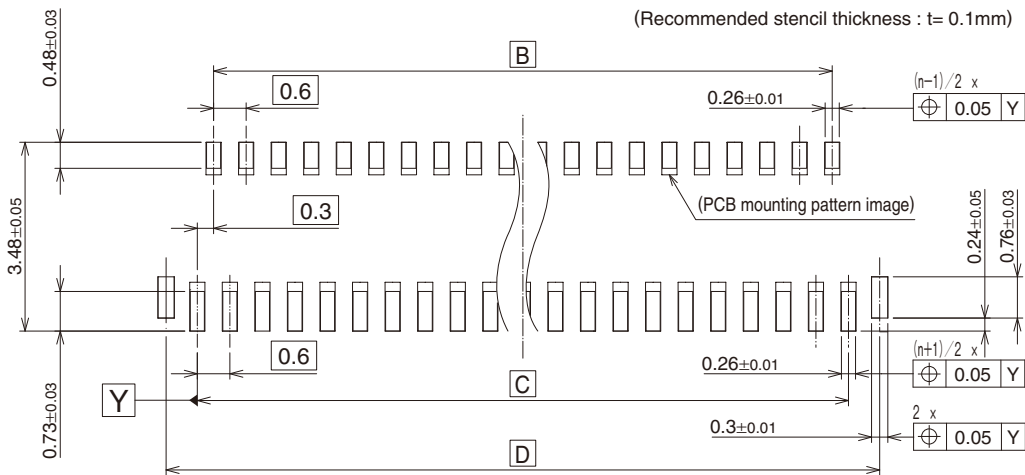

Notes 8. "n" is number of contacts.

Unit : mm

Part No.	HRS No.	No. of Contacts	B	C	D
FH42-7S-0.3SHW(**)	580-2308-6 **	7	1.2	1.8	2.95
FH42-9S-0.3SHW(**)	580-2315-0 **	9	1.8	2.4	3.55
FH42-11S-0.3SHW(**)	580-2306-0 **	11	2.4	3	4.15
FH42-15S-0.3SHW(**)	580-2302-0 **	15	3.6	4.2	5.35
FH42-19S-0.3SHW(**)	580-2305-8 **	19	4.8	5.4	6.55
FH42-23S-0.3SHW(**)	580-2309-9 **	23	6	6.6	7.75
FH42-31S-0.3SHW(**)	580-2301-7 **	31	8.4	9	10.15
FH42-39S-0.3SHW(**)	580-2311-0 **	39	10.8	11.4	12.55

Recommended FPC Pattern

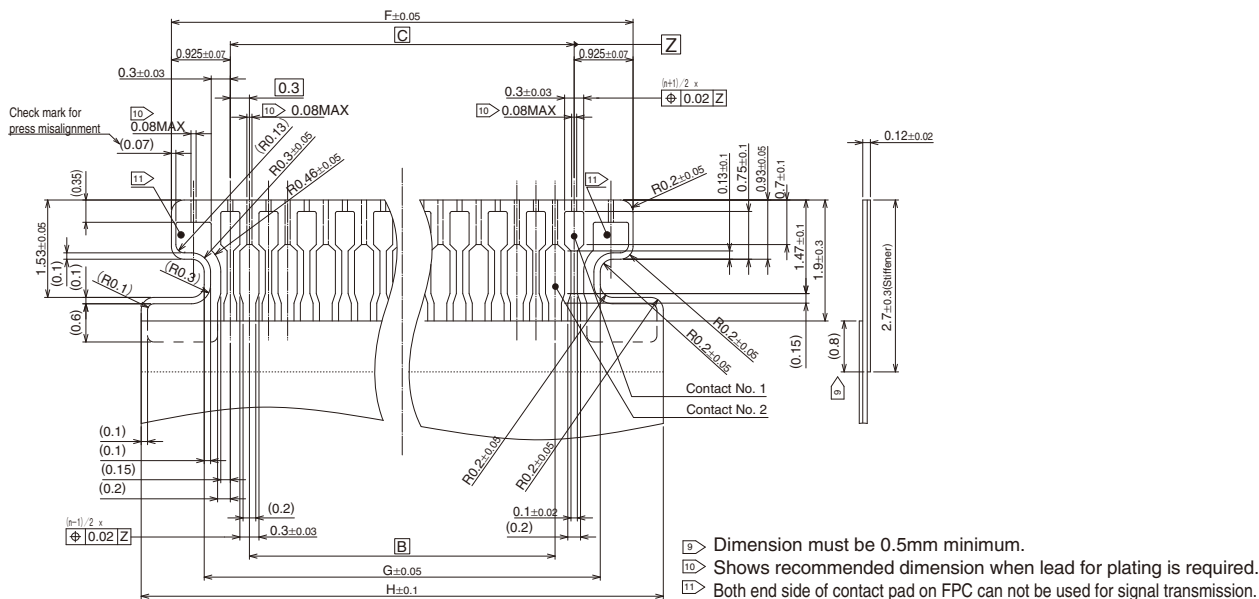

Unit : mm

Part No.	HRS No.	No. of Contacts	B	C	F	G	H
FH42-7S-0.3SHW(**)	580-2308-6 **	7	1.2	1.8	3.65	2.62	4.6
FH42-9S-0.3SHW(**)	580-2315-0 **	9	1.8	2.4	4.25	3.22	5.2
FH42-11S-0.3SHW(**)	580-2306-0 **	11	2.4	3	4.85	3.82	5.8
FH42-15S-0.3SHW(**)	580-2302-0 **	15	3.6	4.2	6.05	5.02	7
FH42-19S-0.3SHW(**)	580-2305-8 **	19	4.8	5.4	7.25	6.22	8.2
FH42-23S-0.3SHW(**)	580-2309-9 **	23	6	6.6	8.45	7.42	9.4
FH42-31S-0.3SHW(**)	580-2301-7 **	31	8.4	9	10.85	9.82	11.8
FH42-39S-0.3SHW(**)	580-2311-0 **	39	10.8	11.4	13.25	12.22	14.2

FH42 Series FPC Material Configuration (Reference Example)

Single-sided FPC

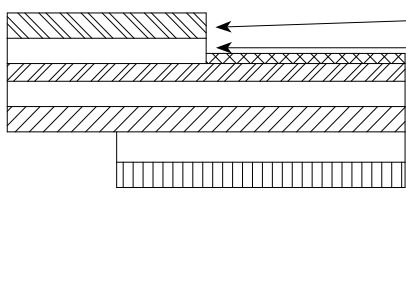

FPC : Flexible Printed Circuit

Material Name	Materials	Thickness (μm)
Covering film layer	Polyimide 1mil	(25)
Cover adhesive		(25)
Surface treatment	1μm to 5μm Nickel underplated 0.2μm Gold plated	3.2
Copper foil	Cu 1/2 oz	18
Base adhesive	Heat-Hardened adhesive	Non-adhesive type
Base film	Polyimide 1mil	25
Reinforcement material adhesive	Heat-Hardened adhesive	35
Stiffener	Polyimide 2mil thick	50
Total		131.2

Precautions

1. This specification is a recommendation for the construction of the FH42 series FPC ($t=0.12 \pm 0.02$).
2. For details about the construction, please contact the FPC manufacturers.

◆ Packaging Specifications

● Embossed carrier tape dimension (Tape width : 24mm MAX)

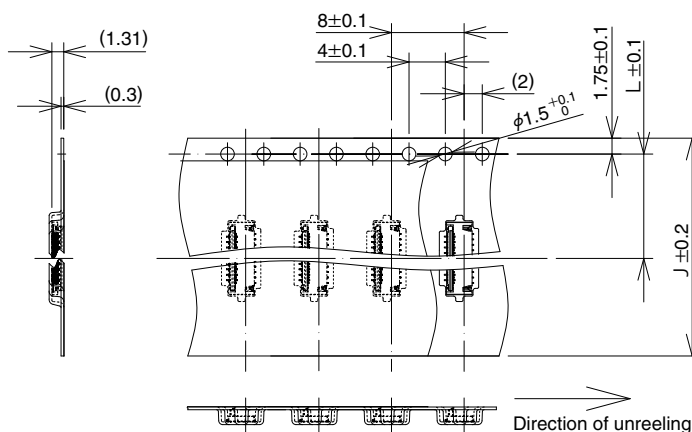

● Embossed carrier tape dimension (Tape width : 32mm MIN)

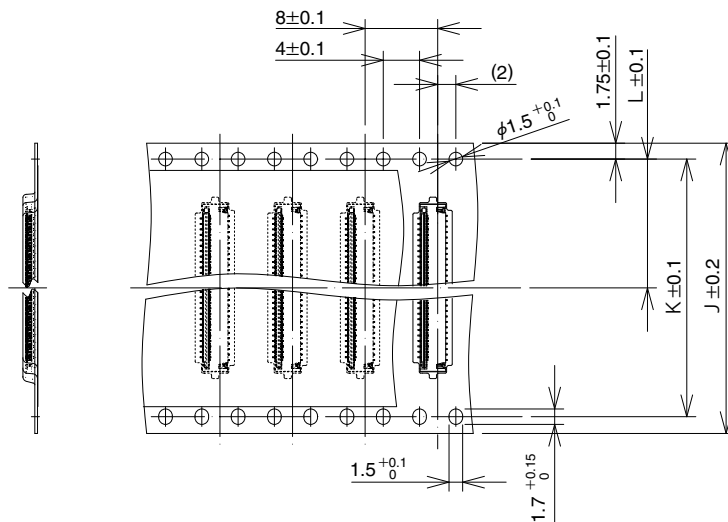

● Reel dimensions

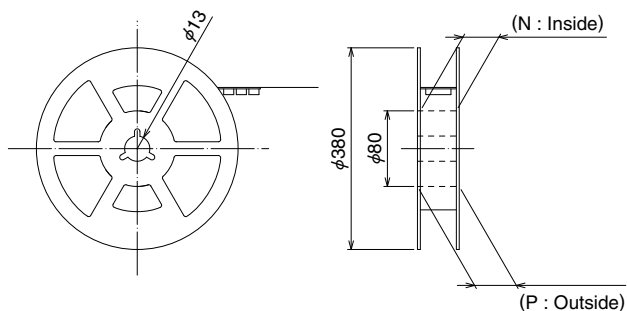

● Leader, Trailer Dimension

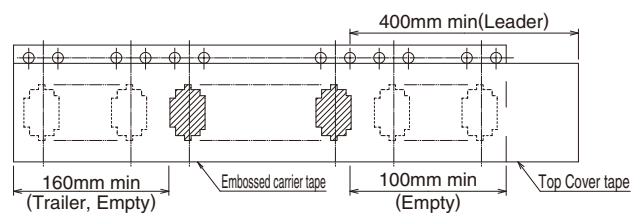

Unit : mm

Part No.	HRS No.	No. of Contacts	J	K	L	N	P
FH42-7S-0.3SHW(**)	580-2308-6 **	7	16	—	7.5	17.4	21.4
FH42-9S-0.3SHW(**)	580-2315-0 **	9	16	—	7.5	17.4	21.4
FH42-11S-0.3SHW(**)	580-2306-0 **	11	16	—	7.5	17.4	21.4
FH42-15S-0.3SHW(**)	580-2302-0 **	15	24	—	11.5	25.4	29.4
FH42-19S-0.3SHW(**)	580-2305-8 **	19	24	—	11.5	25.4	29.4
FH42-23S-0.3SHW(**)	580-2309-9 **	23	24	—	11.5	25.4	29.4
FH42-31S-0.3SHW(**)	580-2301-7 **	31	24	—	11.5	25.4	29.4
FH42-39S-0.3SHW(**)	580-2311-0 **	39	24	—	11.5	25.4	29.4

◆ Temperature Profile

● Using Pb-free solder paste

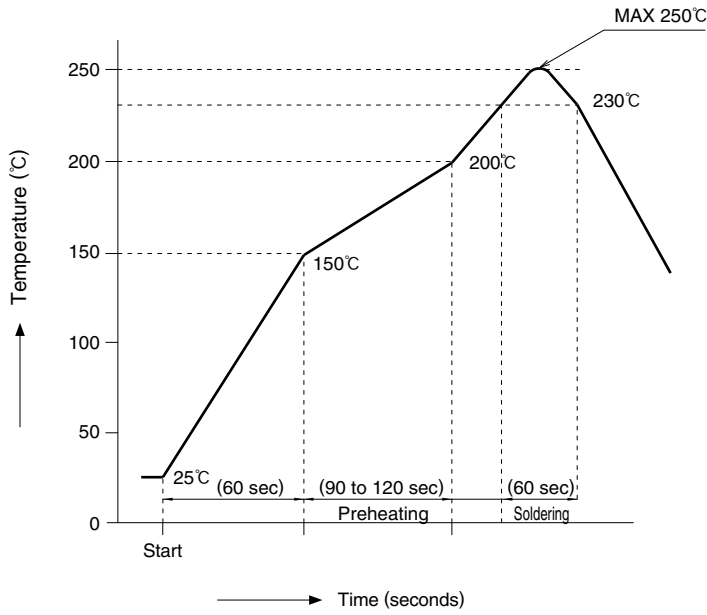

Conditions applied

Reflow method : IR/Hot air
 Reflow environment : Room air
 Solder paste : Paste type Sn/3.0Ag/0.5Cu (M705-GRN360-K2-V from Senju Metal Industry)
 Test PCB : Materials and size Glass epoxy 25×50×0.8mm Land dimension 0.28×0.6, 0.28×0.9mm
 Stencil : Thickness 0.1mm Slot size 0.26×0.48, 0.26×0.73mm

This solder profile is based on the conditions provided above.

Please check the mounting conditions before use, conditions such as solder paste types, manufacturer, PCB size and any other soldering materials may alter the performance of such materials.

Connector Operation and Precautions

[Operation]

This connector needs to be handled with care due to its thin design and miniature stature. Please refer to the following descriptions for handling precautions.

1. Initial condition

- ① Actuator does not have to be operated before inserting FPC, as the connector is delivered with the actuator opened.

[Notes]

- Do not close the actuator before inserting FPC.
- Closing the actuator without FPC could make the contact gap smaller, which could increase the FPC insertion force.

The actuator is open when delivered in tape and reel packaging.

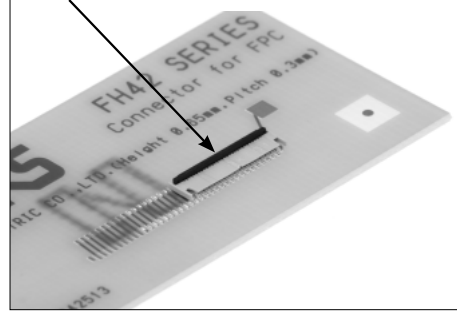

2. How to insert FPC

- ① Insert the FPC into the connector opening horizontally to the PCB plane. Insert it properly to the very end.

[Notes]

- Insert the FPC with actuator opened.
- Do not twist the FPC to up and down, right and left or an angle.

This connector has contacts on the top, insert the FPC with the exposed conductors face up.

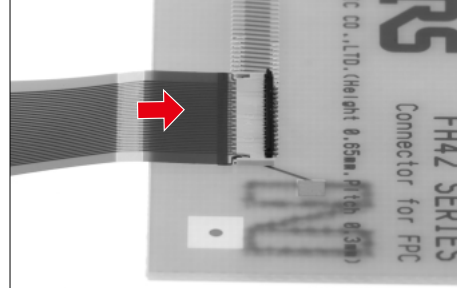

3. FPC insertion check

Metal fittings guide the FPC tabs to the correct position.

Make sure that the FPC tabs are located in proper position as shown in the figure below after FPC insertion.

[Notes]

- Do not insert the FPC at an angle and / or stop it before insertion is completed.

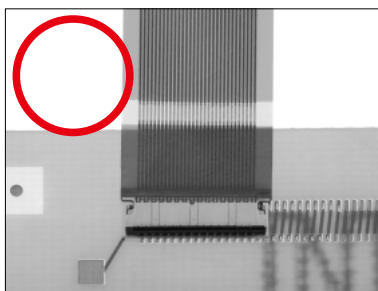
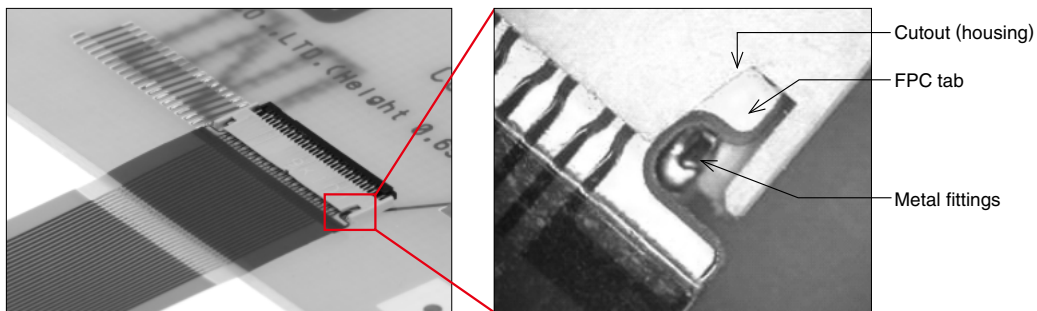

Correct insertion

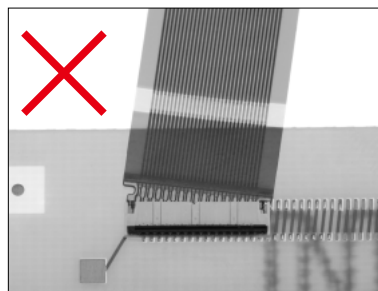

Diagonal insertion

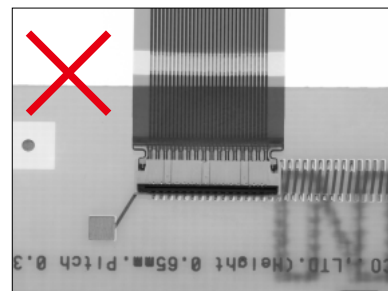

Partial insertion

[Operation]

4. How to lock

- ① Push down the actuator a rotating motion.
 Rotate and flat down the central or entire part of the actuator completely with the ball of a finger.
 (Do not push up only one side of the actuator. The actuator can be twisted causing damage.)
 * Do not apply excessive force to the housing during any operation.

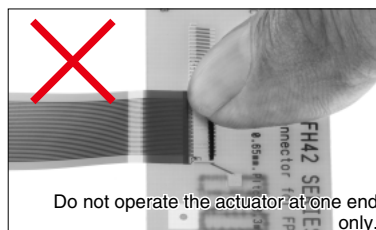
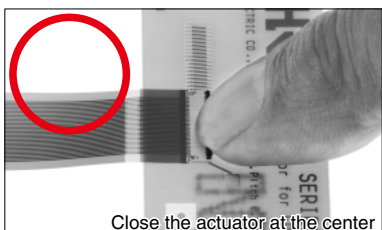
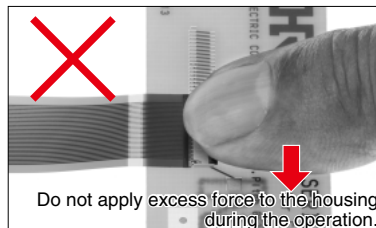

5. How to remove FPC (How to unlock)

- ① After rotating the actuator to the fully opened position carefully withdraw the FPC pulling out at 30 degree angle to the PCB mounting surface.
 (Do not lift up only side of actuator the actuator can be twisted causing damage)
 * The actuator is opened up to the movable limit, 90 degree.
 Do not open the actuator beyond the specified degree or apply excess force to the actuator.

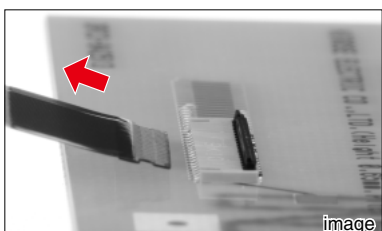
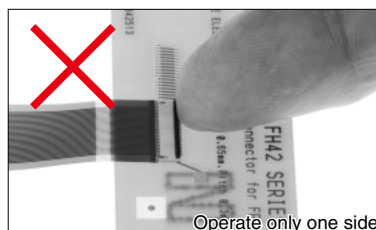
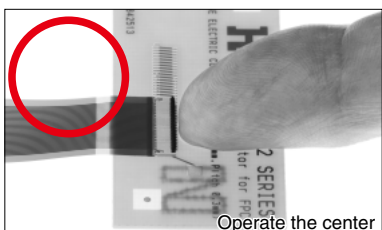
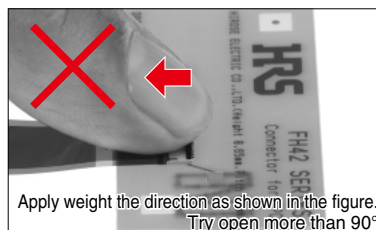
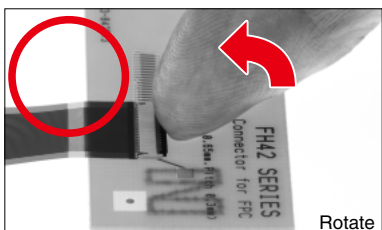

* This connector utilizes a back flip system; the actuator is placed on the side opposite of the FPC insertion opening. Do not attempt to open the actuator from the FPC insertion side.

[Operation]

6. FPC routing after connection

① Depending on a FPC rounding, a load is applied to the connector, and a contact failure may occur , To prevent a failure ,take the following notes into a consideration during mechanism design.

[Notes]

- Make sure that FPC and stiffener do not contact chassis.
- Avoid applying forces to FPC in vertical or horizontal directions.
In addition, avoid pulling up and down on the FPC.
- When fixing FPC after FPC cabling, avoid pulling FPC, and route the wire FPC with slack.
- In this regard, the stiffener is parallel to the PCB.
- Do not mount other components touching to the FPC underneath the FPC stiffener.

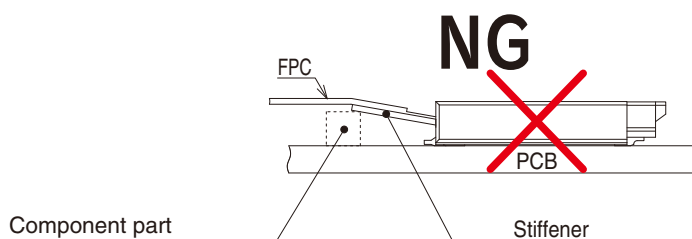
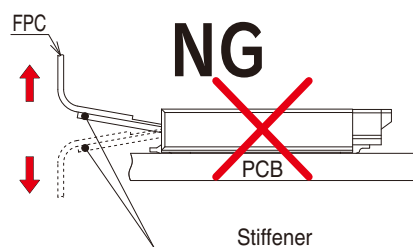
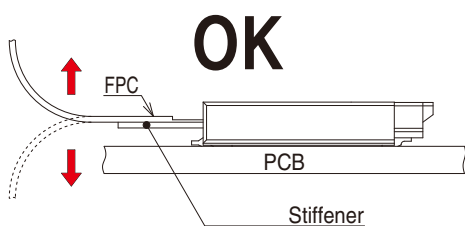
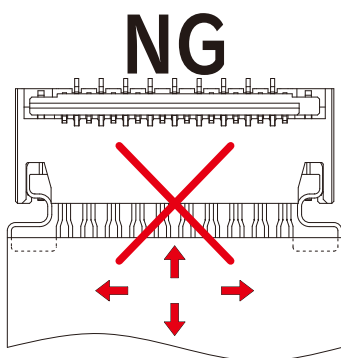

[Precautions when mounting PCB]

- ◆ **Warp of PCB**
Minimize warp of the PCB as much as possible.
Lead co-planarity including reinforced metal fittings is 0.1mm or less.
Too much warp of the PCB may result in a soldering failure.
- ◆ **Flexible board design**
Please make sure to put a stiffener on the backside of the flexible board.
We recommend a glass epoxy material with the thickness of 0.3mm MIN.
- ◆ **Load to connector**
Do not add 0.5N or greater external force when unreel or pick and place the connector etc, or it may get broken.
In addition, do not insert the FPC or operate the connector before mounting.
- ◆ **Load to PCB**
 - Splitting a large PCB into several pieces
 - Screwing the PCB
 Avoid the handling described above so that no force is exerted on the PCB during the assembly process.
Otherwise, the connector may become defective.

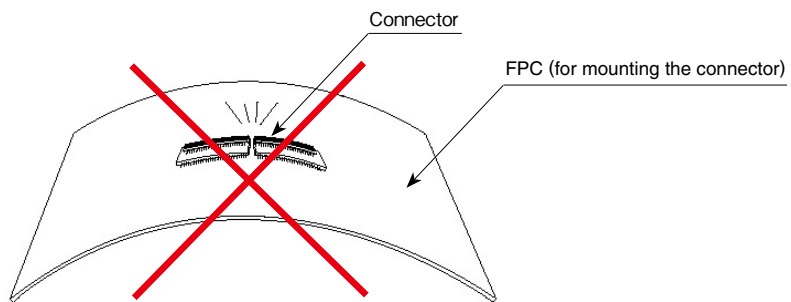

- ◆ **Instructions on manual soldering**
Follow the instructions shown below when soldering the connector manually during repair work, etc.
 - ① Do not perform manual soldering with the FPC inserted into the connector.
 - ② Do not heat the connector excessively. Be very careful not to let the soldering iron contact any parts other than connector leads. Otherwise, the connector may be deformed or melt.
 - ③ Do not supply excessive solder(or flux).
 If excessive solder (or flux) is supplied on the terminals, solder or flux may adhere to the contacts or rotating parts of the actuator, resulting in poor contact or a rotation failure of the actuator.
Supplying excessive solder to the metal fittings may hinder actuator rotation, resulting in breakage of the connector.

USA:

HIROSE ELECTRIC (U.S.A.), INC. HEADQUARTERS CHICAGO OFFICE
2300 Warrenville Road, Suite 150,
Downers Grove, IL 60515
Phone : +1-630-282-6700
<http://www.hirose.com/us/>

USA:

HIROSE ELECTRIC (U.S.A.), INC. SAN JOSE OFFICE
2841 Junction Ave, Suite 200
San Jose, CA. 95134
Phone : +1-408-253-9640
Fax : +1-408-253-9641
<http://www.hirose.com/us/>

USA:

HIROSE ELECTRIC (U.S.A.), INC. DETROIT OFFICE (AUTOMOTIVE)
17197 N. Laurel Park Drive, Suite 253,
Livonia, MI 48152
Phone : +1-734-542-9963
Fax : +1-734-542-9964
<http://www.hirose.com/us/>

USA:

HIROSE ELECTRIC (U.S.A.), INC. BOSTON OFFICE
300 Brickstone Square Suite 201,
Andover, MA 01810
Phone : +1-978-662-5255

THE NETHERLANDS:

HIROSE ELECTRIC EUROPE B.V.
Hogehillweg #8 1101 CC Amsterdam Z-0
Phone : +31-20-6557460
Fax : +31-20-6557469
<http://www.hirose.com/eu/>

GERMANY:

HIROSE ELECTRIC EUROPE B.V. GERMAN BRANCH
Schoenbergstr. 20, 73760 ostfildern
Phone : +49-711-456002-1
Fax : +49-711-456002-299
<http://www.hirose.com/eu/>

GERMANY:

HIROSE ELECTRIC EUROPE B.V. NUREMBERG OFFICE
Neumeyerstrasse 22-26, 90411 Nurnberg
Phone : +49-911 32 68 89 63
Fax : +49-911 32 68 89 69
<http://www.hirose.com/eu/>

GERMANY:

HIROSE ELECTRIC EUROPE B.V. HANOVER OFFICE
Bayernstr. 3, Haus C 30855 Langenhagen, Germany
Phone : +49-511 97 82 61 30
Fax : +49-511 97 82 61 35
<http://www.hirose.com/eu/>

FRANCE:

HIROSE ELECTRIC EUROPE B.V. PARIS OFFICE
130 Avenue Joseph Kessel, Bat E, 78960
Voisins le Bretonneux, France
Phone : +33-1-85764886
Fax : +33-1-85764823
<http://www.hirose.com/eu/>

UNITED KINGDOM:

HIROSE ELECTRIC EUROPE BV (UK BRANCH)
4 Newton Court, Kelvin Drive, Knowlhill,
Milton Keynes, MK5 8NH
Phone : +44-1908 202050
Fax : +44-1908 202058
<http://www.hirose.com/eu/>

CHINA:

HIROSE ELECTRIC (CHINA) CO., LTD. (SHANGHAI, HEADQUARTERS)
18, Enterprise Center Tower 2, 209# Gong He
Road, Jing'an District, Shanghai, CHINA 200070
Phone : +86-21-6391-3355
Fax : +86-21-6391-3335
<http://www.hirose.com/cn/>

CHINA:

HIROSE ELECTRIC (CHINA) CO.,LTD. BEIJING BRANCH
A1001, Ocean International Center, Building 56# East 4th
Ring Middle Road, ChaoYang District, Beijing, 100025
Phone : +86-10-5165-9332
Fax : +86-10-5908-1381
<http://www.hirose.com/cn/>

CHINA:

HIROSE ELECTRIC (CHINA) CO., LTD. SHENZHEN BRANCH
Room 09-13, 19/F, Office Tower Shun Hing Square, Di Wang Commercial Centre,
5002 Shen Nan Dong Road, Shenzhen City, Guangdong Province, 518008
Phone : +86-755-8207-0851
Fax : +86-755-8207-0873
<http://www.hirose.com/cn/>

HONG KONG:

HIROSE ELECTRIC HONGKONG TRADING CO., LTD.
Room 1001, West Wing, Tsim Sha Tsui Centre, 66
Mody Road, Tsim Sha Tsui East, Kowloon, Hong Kong
Phone : +852-2803-5338
Fax : +852-2591-6560
<http://www.hirose.com/hk/>

TAIWAN:

HIROSE ELECTRIC TAIWAN CO., LTD.
103 8F, No.87, Zhengzhou Rd., Taipei
Phone : +886-2-2555-7377
Fax : +886-2-2555-7355
<http://www.hirose.com/tw/>

KOREA:

HIROSE KOREA CO.,LTD.
143, Gongdan 1-daero, Siheung-si,
Gyeonggi-do, 15084, Korea
Phone : +82-31-496-7000
Fax : +82-31-496-7100
<http://www.hirose.co.kr/>

SINGAPORE:

HIROSE ELECTRIC SINGAPORE PTE. LTD.
03, Anson Road, #20-01, Springleaf Tower,
Singapore 079909
Phone : +65-6324-6113
Fax : +65-6324-6123
<http://www.hirose.com/sg/>

INDIA:

HIROSE ELECTRIC SINGAPORE PTE. LTD. DELHI LIAISON OFFICE
Office NO.552, Regus-Green Boulevard, Level5, Tower C,
Sec62, Plot B-9A, Block B, Noida, 201301, Uttar Pradesh, India
Phone : +91-12-660-8018
Fax : +91-120-4804949
<http://www.hirose.com/sg/>

INDIA:

HIROSE ELECTRIC SINGAPORE PTE. LTD. BANGALORE LIAISON OFFICE
Unit No-403, 4th Floor, No-84, Barton Centre, Mahatma
Gandhi (MG) Road, Bangalore 560 001, Karnataka, India
Phone : +91-80-4120 1907
Fax : +91-80-4120 9908
<http://www.hirose.com/sg/>

MALAYSIA:

PENANG REPRESENTATIVE OFFICE
73-3-1, Ideal@The One, Jalan Mahsuri, Bayan
Lepas Penang, 11950, Malaysia
Phone : +604-648-5536
<http://www.hirose.com/sg/>

THAILAND:

BANGKOK OFFICE (REPRESENTATIVE OFFICE)
Unit 4703, 47th FL., 1 Empire Tower, South Sathorn
Road, Yannawa, Sathorn, Bangkok 10120 Thailand
Phone : +66-2-686-1255
Fax : +66-2-686-3433
<http://www.hirose.com/sg/>



HIROSE ELECTRIC CO.,LTD.

2-6-3,Nakagawa Chuoh,Tsuzuki-Ku,Yokohama-Shi 224-8540,JAPAN
TEL: +81-45-620-3526 Fax: +81-45-591-3726
<http://www.hirose.com>
<http://www.hirose-connectors.com>