

0.2 mm Pitch, 1.2 mm Height, FPC Connector

FH29 Series

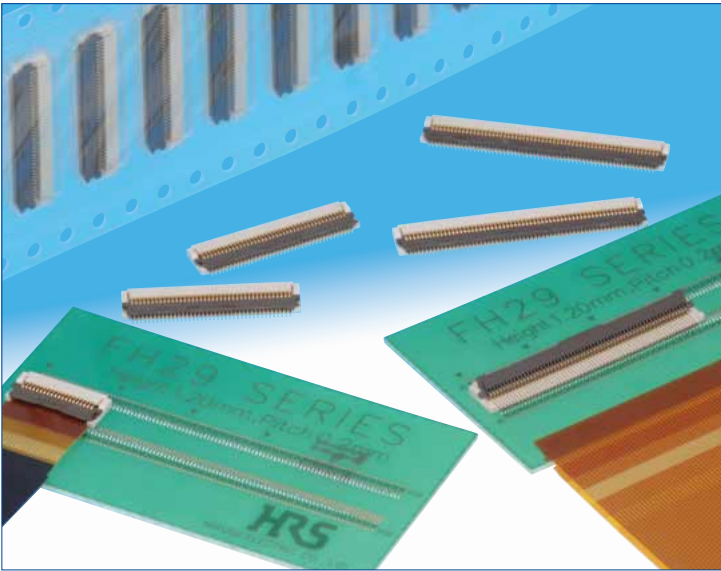

- Easy mounting with double-sided lead design
1.2 mm height, 4.55 mm mounting depth

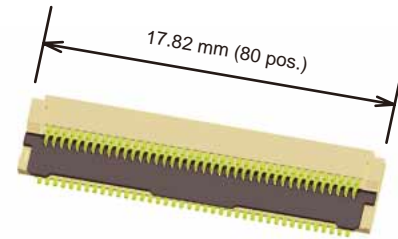
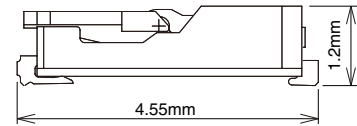

■ Features

1. Space saving 0.2 mm pitch FPC connector

Super thin, space saving design with 1.2 mm connector height and 4.55 mm mounting depth.

*40% reduction in PCB footprint

*50% reduction in weight

(Compared to our 0.3 mm pitch FH23 Series 80 position connector.)

2. With metal fitting type is also available

The addition of reinforcing metal fittings improve the operability during actuator operation.

3. Easy solderability on the PCB

The leads are double sided and have 0.4 mm mounting lead pitch to simplify mounting.

4. Easy FPC insertion

The FPC aligning mechanism holds onto the FPC prior to locking the actuator. This also helps to increase the retention force of this connector.

5. Accepts standard 0.2 mm thick FPC

This connector accepts standard 0.2 mm thick FPC.

(A stiffener with adequate strength will prevent FPC deformation and ease insertion and mating.)

6. Rotating one-touch ZIF mechanism

The one-touch rotating ZIF mechanism is easier to operate and works with a light force, and a clear tactile click is delivered upon the successful completion of the mating process

7. Molded structure aids PCB layout

The bottom of this connector is enclosed by a fully molded structure that protects the contacts and removes any restrictions from PCB patterning and layout design.

8. Suitable for automatic pick-n-place mounting

Offered in tape and reel packaging that is compatible with automatic machine mounting. (5,000 pieces per reel)

9. Halogen-free

Halogen free connectors are available; please use the FH29BW, FH29BJ and FH29DJ type connectors. All materials and substances used to produce the FH29BW, FH29BJ, FH29DJ series product complies with Halogen-free standards. * Defined according to IEC61249-2-21 Br: 900ppm max, Cl: 900ppm max, Br+Cl: 1,500ppm max.

10. Suitable for automatic pick-n-place mounting

The standard packaging is 5,000 pieces per reel, but it is also offered in a 500 piece reel. (The outer diameter of the reel will be -180 mm in this case.)

- With metal fitting type

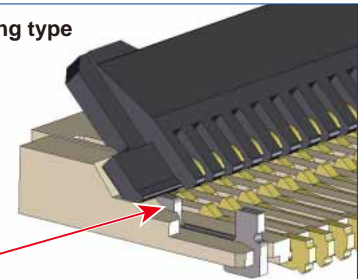

The reinforcing metal fittings support the actuator from below, this leads to an easier locking function.

- FPC insertion

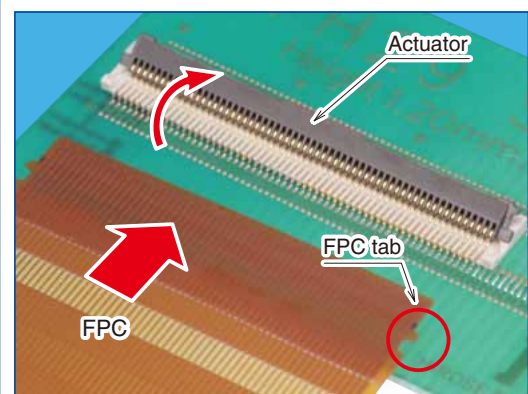

- FPC lock completion

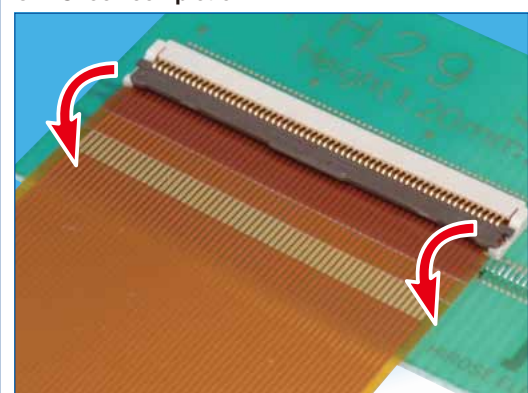

Product Specifications

Rating	Rated current: DC 0.25 A (Note 1) Rated voltage: AC/DC 40 Vrms	Operating temperature range: -55°C to 85°C (Note 2) Operating humidity range: relative humidity 90% max (No condensation)	Storage temperature range: -10°C to 50°C (Note 3) Storage humidity range: relative humidity 90% max (No condensation)
--------	---	---	---

Recommended FPC spec.	Thickness = 0.2 ±0.03 mm gold plated
-----------------------	--------------------------------------

Item	Specifications	Conditions
1. Insulation resistance	500 MΩ min.	DC 100 V
2. Withstanding voltage	No flashover or insulation breakdown	AC 120 Vrms/1 minutes
3. Contact resistance	100 mΩ max. * including FPC conductor resistance	1 mA
4. Durability	Contact resistance: 100 mΩ max. No damage, cracks, or parts dislocation.	20 mating cycles
5. Vibration	No electrical discontinuity of 1 μs or longer. Contact resistance: 100 mΩ max. No damage, cracks, or parts dislocation.	frequency: 10 to 55 Hz, single amplitude of 0.75/mm, 10 cycles in each of the 3 directions
6. Shock	No electrical discontinuity of 1 μs or longer. Contact resistance: Maximum of 100 mΩ max. No damage, cracks, or parts dislocation.	Acceleration of 981 m/s ² , 6 ms duration, sine half-wave, 3 cycles in each of the 3 axial directions
7. Humidity (steady state)	Contact resistance: Maximum of 100 mΩ max. Insulation resistance: . Minimum of 50 MΩ min. No damage, cracks, or parts dislocation.	96 hours at 40°C and humidity of 90 to 95%
8. Temperature cycle	Contact resistance: Maximum of 100 mΩ max. Insulation resistance: Minimum of 50 MΩ min. No damage, cracks, or parts dislocation.	Temperature: -55 → +15 to +35 → +85 → +15 to +35°C Time: 30 → 2 to 3 → 30 → 2 to 3 minutes 5 cycles
9. Resistance to soldering heat	No deformation of components affecting performance.	1) Reflow: peak temperature 250°C max, 60 seconds max at above 230°C. 2) Manual soldering: 350°C ± 10°C for 5 seconds.

Note 1: When energizing rated current to all contacts, use 70% of rated current.

Note 2: Includes temperature rise caused by current flow.

Note 3: The term "storage" here refers to products stored for a long period prior to board mounting and use. The operating temperature and humidity range covers the non-energized condition of connectors after board mounting and the temporary storage.

Materials

Parts	Materials	Color/Finish	Remarks
Insulator	LCP	Beige	UL94V-0
	PA	FH29B Series : Deep brown	
		PPS	FH29BJ, FH29DJ Series: Black
Contacts	Phosphor bronze	Gold plated	-----

Product Number Structure

Refer to this page when determining product specifications by model types. Please place orders with part numbers listed in this catalog. The characteristics and specifications of the product described in this catalog are reference values. Please make sure to check the latest delivery specifications at the time of product use.

FH 29 B W - 80S - 0.2 SHW (05)

①
②
③
④
⑤
⑥
⑦
⑧

① Series name : FH	⑤ No. of contacts: 22 to 120
② Series No. : 29	⑥ Contact pitch: 0.2 mm
③ B: Standard type D: With metal fitting type Blank: Standard	⑦ Terminal type SHW: SMT double-sided lead horizontal mount type
④ W: Halogen-free (flame retardance UL94HB) J: Halogen-free (flame retardance UL94V-0)	⑧ Plating specifications (05) Gold plating with nickel barrier, 5,000 pieces per reel (99) Gold plating with nickel barrier, 500 pieces per reel

Connector Dimensional Drawing

[Standard type]

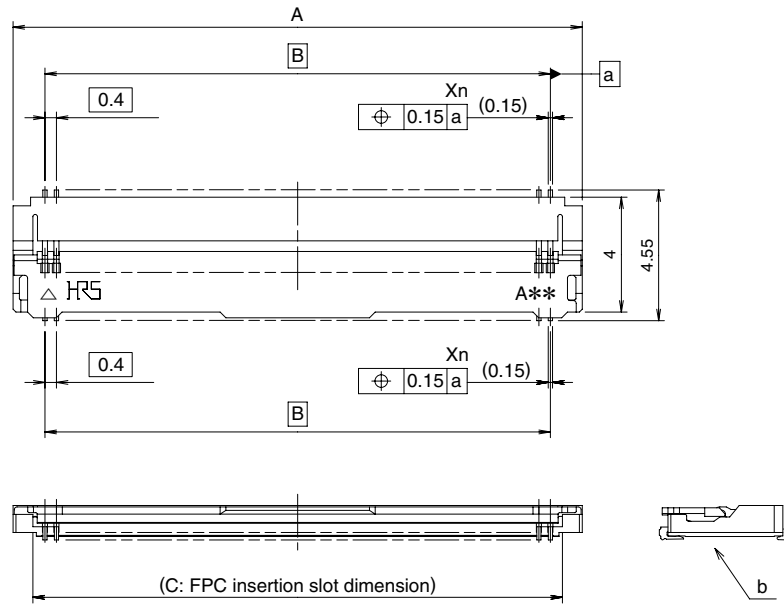

Detailed drawing of b

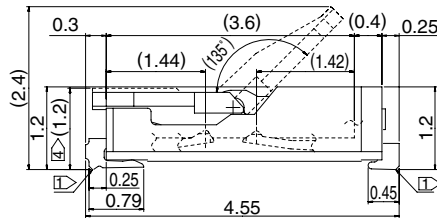

Note 1): The coplanarity of each terminal lead is within 0.1 max.

2 : This product is packaged and sold by tape and reel. For details on the packing, please refer to the drawing specifications on page 7.

3 : Recesses in part structure may be added to improve molding characteristics. Black marks may appear in the mold resin, but they will not negatively affect the performance of these connectors.

4): Outline of the actuator is as shown by broken lines with connectors with 92 or more positions.

5 : The color of the plating may change after the reflow process, but it will not negatively affect the performance of these connectors.

Connector Dimensional Table

Unit: mm

Part No.	HRS No.	No. of Contacts	A	B	C	n
FH29BW-22S-0.2SHW(**)	CL580-0325-4-**-	22	6.22	4	4.84	11
FH29BW-24S-0.2SHW(**)	CL580-0323-9-**-	24	6.62	4.4	5.24	12
FH29BJ-34S-0.2SHW(**)	CL580-0331-7-**-	34	8.62	6.4	7.24	17
FH29B-40S-0.2SHW(**)	CL580-0313-5-**-	40	9.82	7.6	8.44	20
FH29B-44S-0.2SHW(**)	CL580-0314-8-**-	44	10.62	8.4	9.24	22
FH29BW-44S-0.2SHW(**)	CL580-0324-1-**-					
FH29B-50S-0.2SHW(**)	CL580-0315-0-**-	50	11.82	9.6	10.44	25
FH29BJ-60S-0.2SHW(**)	CL580-0330-4-**-	60	13.82	11.6	12.44	30
FH29BJ-70S-0.2SHW(**)	CL580-0327-0-**-	70	15.82	13.6	14.44	35
FH29BJ-80S-0.2SHW(**)	CL580-0329-5-**-	80	17.82	15.6	16.44	40
FH29BJ-90S-0.2SHW(**)	CL580-0334-5-**-	90	19.82	17.6	18.44	45
FH29B-100S-0.2SHW(**)	CL580-0320-0-**-	100	21.82	19.6	20.44	50
FH29B-120S-0.2SHW(**)	CL580-0328-2-**-	120	25.82	23.6	24.44	60

(Note 1) This product is packaged on tape and reel and is only sold in full reel quantities of either 5,000 or 500 piece reels. Please place orders by full reel quantities.

Connector Dimensional Drawing

[With reinforcement metal fittings type]

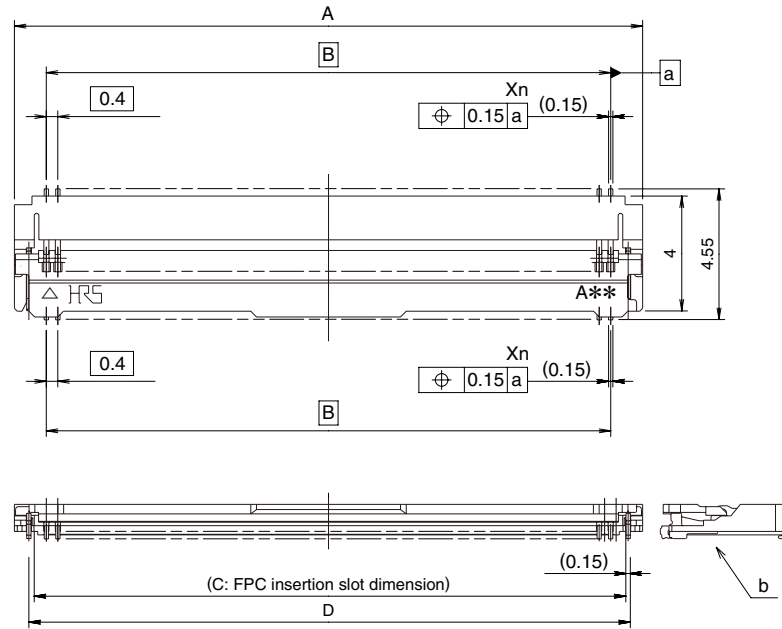

Detailed drawing of b

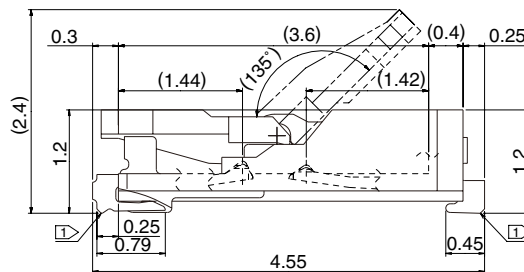

Note 1: The coplanarity of each terminal lead is within 0.1 max.

2 : This product is packaged and sold by tape and reel. For details on the packing, please refer to the drawing specifications on page 7.

3 : Recesses in part structure may be added to improve molding characteristics. Black marks may appear in the mold resin, but they will not negatively affect the performance of these connectors.

4 : The color of the plating may change after the reflow process, but it will not negatively affect the performance of these connectors.

Connector Dimensional Table

Unit: mm

Part No.	HRS No.	No. of Contacts	A	B	C	D	n
FH29DJ-44S-0.2SHW(**)	CL580-0337-3-**-	44	10.62	8.4	9.24	9.615	22
FH29DJ-50S-0.2SHW(**)	CL580-0338-6-**-	50	11.82	9.6	10.44	10.815	25
FH29DJ-70S-0.2SHW(**)	CL580-0336-0-**-	70	15.82	13.6	14.44	14.815	35
FH29DJ-80S-0.2SHW(**)	-----	80	17.82	15.6	16.44	16.815	40
FH29DJ-90S-0.2SHW(**)	CL580-0340-8-**-	90	19.82	17.6	18.44	18.815	45
FH29DJ-100S-0.2SHW(**)	CL580-0335-8-**-	100	21.82	19.6	20.44	20.815	50
FH29DJ-110S-0.2SHW(**)	CL580-0339-9-**-	110	23.82	21.6	22.44	22.815	55
FH29DJ-120S-0.2SHW(**)	-----	120	25.82	23.6	24.44	24.815	60

(Note 1) This product is packaged on tape and reel and is only sold in full reel quantities of either 5,000 or 500 piece reels. Please place orders by full reel quantities.

Recommended PCB Layout and Stencil Dimensional Drawing

[Standard type] Recommended stencil thickness: $t = 0.12 \text{ mm}$

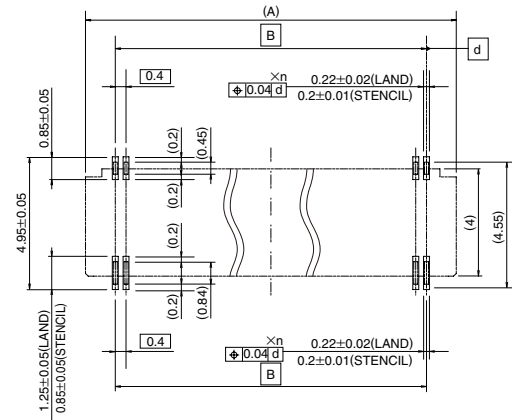

Recommended PCB Layout and Stencil Dimensional Table

Unit: mm

Part No.	HRS No.	No. of Contacts	A	B	n
FH29BW-22S-0.2SHW(**)	CL580-0325-4-**-	22	6.22	4	11
FH29BW-24S-0.2SHW(**)	CL580-0323-9-**-	24	6.62	4.4	12
FH29BJ-34S-0.2SHW(**)	CL580-0331-7-**-	34	8.62	6.4	17
FH29B-40S-0.2SHW(**)	CL580-0313-5-**-	40	9.82	7.6	20
FH29B-44S-0.2SHW(**)	CL580-0314-8-**-	44	10.62	8.4	22
FH29BW-44S-0.2SHW(**)	CL580-0324-1-**-				
FH29B-50S-0.2SHW(**)	CL580-0315-0-**-	50	11.82	9.6	25
FH29BJ-60S-0.2SHW(**)	CL580-0330-4-**-	60	13.82	11.6	30
FH29BJ-70S-0.2SHW(**)	CL580-0327-0-**-	70	15.82	13.6	35
FH29BJ-80S-0.2SHW(**)	CL580-0329-5-**-	80	17.82	15.6	40
FH29BJ-90S-0.2SHW(**)	CL580-0334-5-**-	90	19.82	17.6	45
FH29B-100S-0.2SHW(**)	CL580-0320-0-**-	100	21.82	19.6	50
FH29BJ-120S-0.2SHW(**)	CL580-0328-2-**-	120	25.82	23.6	60

Recommended PCB Layout and Stencil Dimensional Drawing

[With reinforcement metal fittings type]

Recommended stencil thickness: $t = 0.12 \text{ mm}$

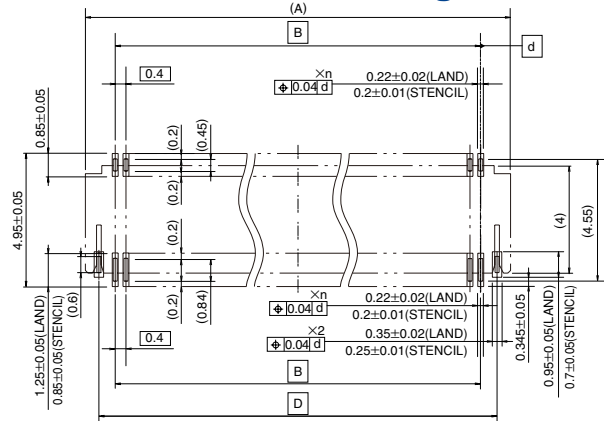

Recommended PCB Layout and Stencil Dimensional Table

Unit: mm

Part No.	HRS No.	No. of Contacts	A	B	D	n
FH29DJ-44S-0.2SHW(**)	CL580-0337-3-**-	44	10.62	8.4	9.615	22
FH29DJ-50S-0.2SHW(**)	CL580-0338-6-**-	50	11.82	9.6	10.815	25
FH29DJ-70S-0.2SHW(**)	CL580-0336-0-**-	70	15.82	13.6	14.815	35
FH29DJ-80S-0.2SHW(**)	—————	80	17.82	15.6	16.815	40
FH29DJ-90S-0.2SHW(**)	CL580-0340-8-**-	90	19.82	17.6	18.815	45
FH29DJ-100S-0.2SHW(**)	CL580-0335-8-**-	100	21.82	19.6	20.815	50
FH29DJ-110S-0.2SHW(**)	CL580-0339-9-**-	110	23.82	21.6	22.815	55
FH29DJ-120S-0.2SHW(**)	—————	120	25.82	23.6	24.815	60

Recommended FPC Dimensional Drawing

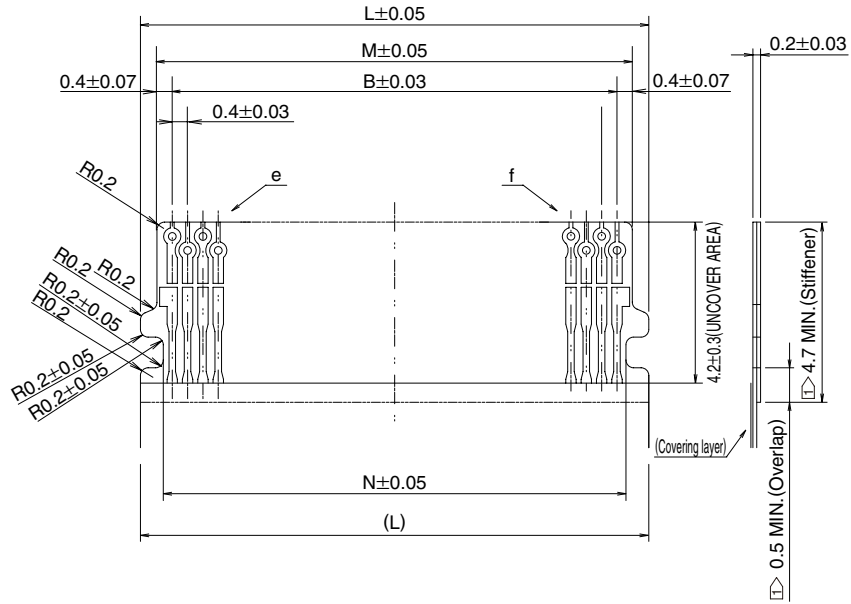

Detailed drawing of e and f

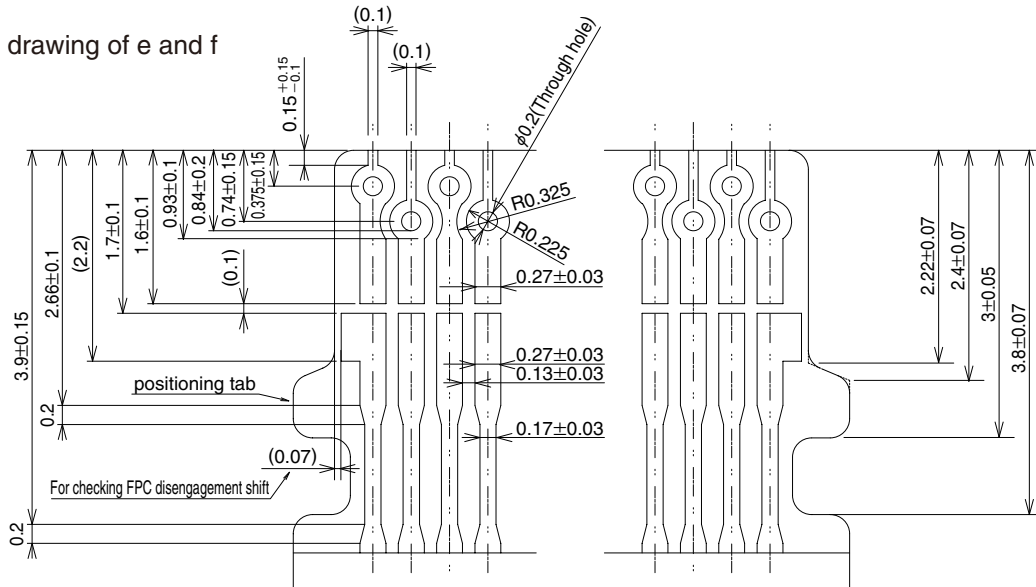

Note ①: To prevent pattern cutting, in case 4.7 mm or more of stiffener cannot be secured, make the overlap amount to 0.5 mm or more.

Recommended FPC Dimensional Table

Unit: mm

No. of Contacts	B	L	M	N
22	4	5.66	4.8	4.47
24	4.4	6.06	5.2	4.87
34	6.4	8.06	7.2	6.87
40	7.6	9.26	8.4	8.07
44	8.4	10.06	9.2	8.87
50	9.6	11.26	10.4	10.07
60	11.6	13.26	12.4	12.07
70	13.6	15.26	14.4	14.07
80	15.6	17.26	16.4	16.07
90	17.6	19.26	18.4	18.07
100	19.6	21.26	20.4	20.07
110	21.6	23.26	22.4	22.07
120	23.6	25.26	24.4	24.07

■ Packaging Specifications

● Embossed carrier tape dimension
(Maximum tape width of 24 mm)

A-A

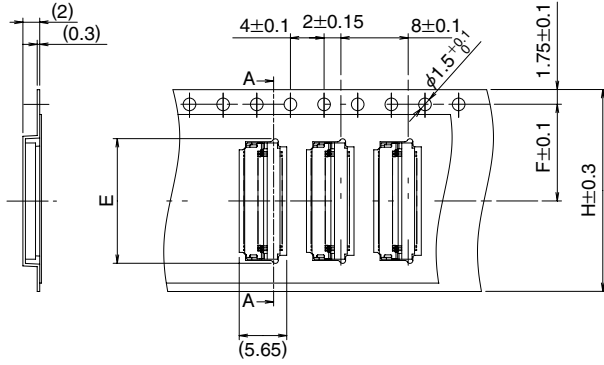

● Embossed carrier tape dimension
(Minimum tape width of 32 mm)

A-A

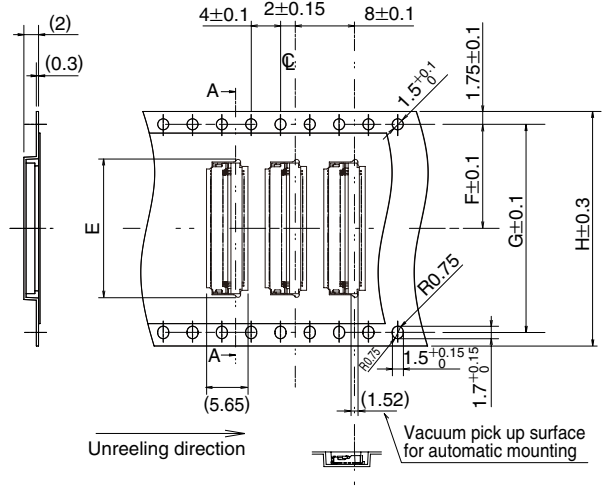

● Reel Dimensions

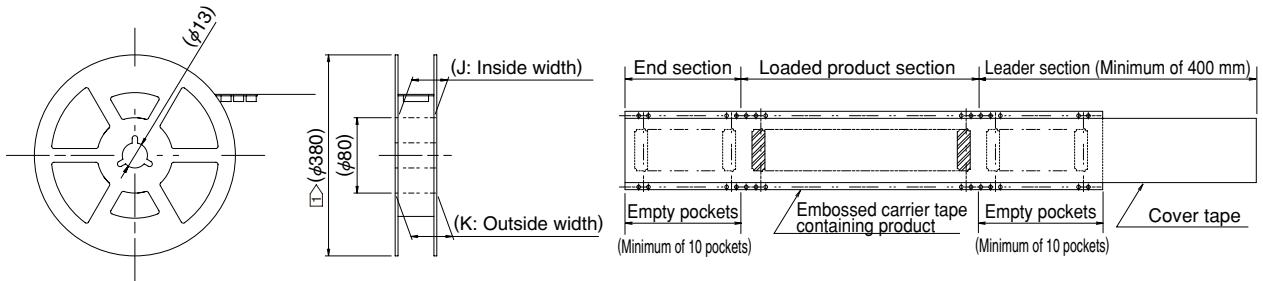

① The above dimensions are for the 5,000 piece reel. The outer diameter for the embossed 500 piece reel is ϕ 180 mm.

■ Packaging Specification Dimensions

Unit: mm

No. of Contacts	E	F	G	H	J	K
22	7.22	7.5	—	16	17.4	21.4
24	7.62	11.5	—	24	25.4	29.4
34	9.62	11.5	—	24	25.4	29.4
40	10.82	11.5	—	24	25.4	29.4
44	11.62	11.5	—	24	25.4	29.4
50	12.82	11.5	—	24	25.4	29.4
60	14.82	11.5	—	24	25.4	29.4
70	16.82	11.5	—	24	25.4	29.4
80	18.82	14.2	28.4	32	33.4	37.4
90	20.82	20.2	40.4	44	45.4	49.4
100	22.82	20.2	40.4	44	45.4	49.4
110	24.82	20.2	40.4	44	45.4	49.4
120	26.82	20.2	40.4	44	45.4	49.4

FPC Materials Configuration (Recommended Specifications)

1. Double-sided FPC

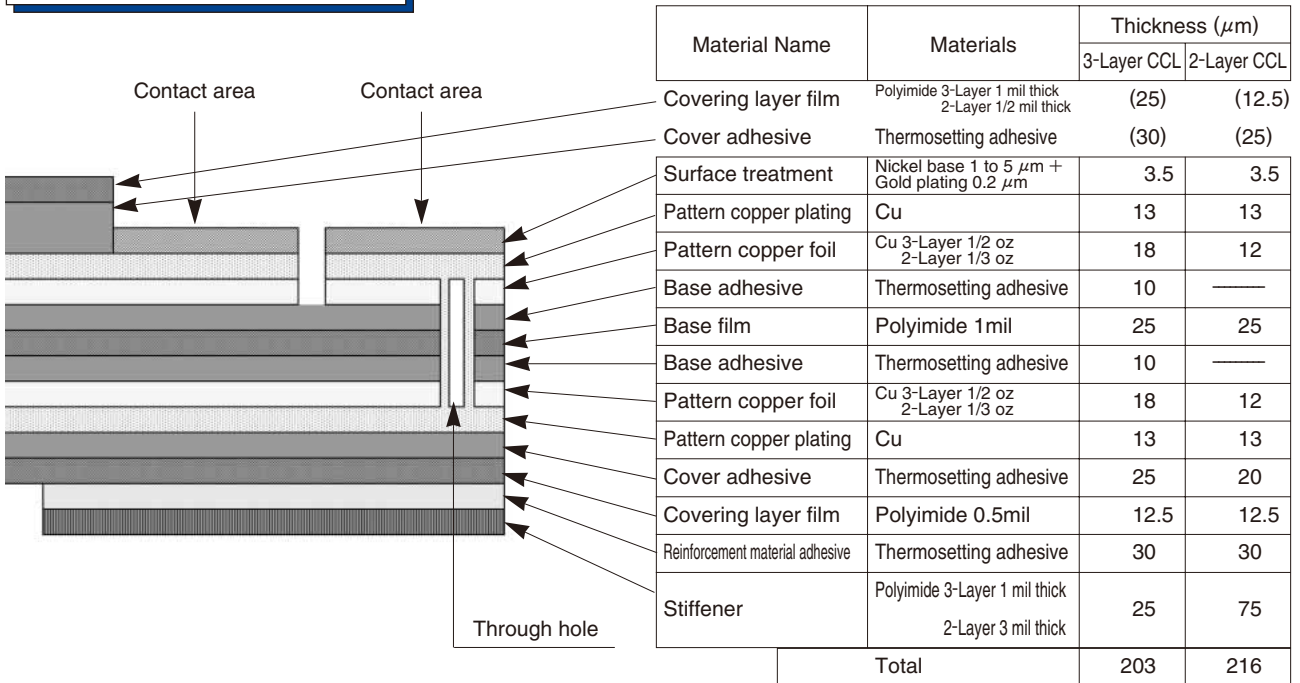

2. Precautions

1. These specifications are an example of the material configuration of an FPC/FFC (t = 0.2 ±0.03) used on the FH29 series.
2. Please contact the FPC/FFC manufacturer for the material configurations of their FPC/FFC.

Recommended Soldering Profile

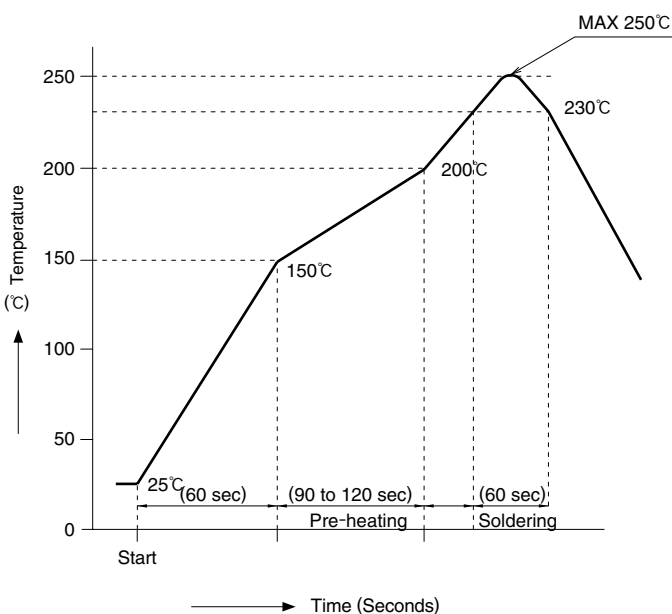

Conditions applied

- Reflow method : IR/Hot air
- Reflow environment : Room air
- Solder paste : Paste type Sn/3.0Ag/0.5Cu (M705-221CM5-32-10.5 from Senju Metal Industry)
- Test PCB : Materials and size
Glass epoxy 25×45×0.8 mm
Footprint dimensions
0.22×0.85, 0.22×1.25 mm
- Stencil : Thickness 0.12 mm
Slot size 0.20×0.85 mm

This temperature profile is based on the conditions provided above. Please check the mounting conditions before use, conditions such as solder paste types, manufacturer, PCB size and any other soldering materials may alter the performance of such materials.

Connector Operation and Precautions

Operation

1. FPC insertion

- 1 Rotate the actuator upward to unlock it (Release the lock.)
The actuator can be easily operated with the use of a thumb nail or index finger.

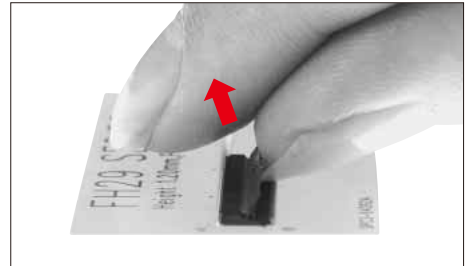

- 2 Insert the FPC into the connector with the conductive traces facing down. There is an FPC alignment tab that requires FPC to be inserted at an angle of about 10 degrees with respect to PCB surface and perpendicular to the connector. The FPC should be inserted firmly all the way to the back.

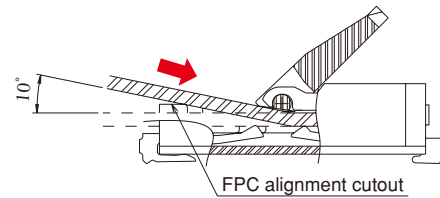
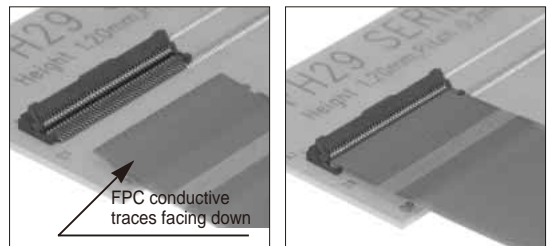

- 3 Rotate the actuator downward.
If the FPC has not been fully inserted or is extremely skewed, disengage the FPC and follow the directions described in 2-1 "FPC Removal" and then repeat the operations from 1-1. Always make sure that the FPC is secured prior to locking the actuator.

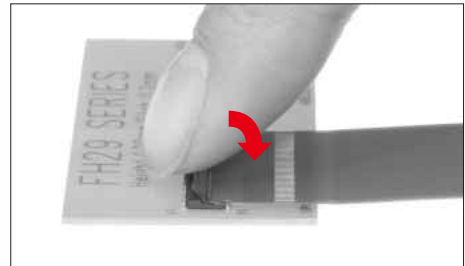

2. FPC removal

- 1 Rotate the actuator upward, and then pull the FPC out by using the alignment tabs as a guide. The FPC should be removed at a 10 degree angle to the PCB surface.

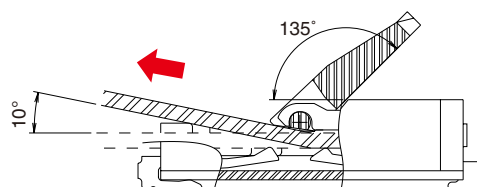
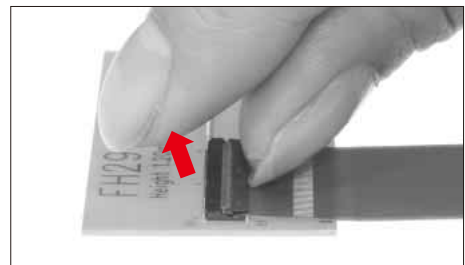

Usage Precautions

This connector needs to be handled with care due to its thin design and miniature stature.

[Precautions when mounting PCB]

◆ Acceptable amount of PCB distortion

The PCB distortion should be kept to a minimum. The maximum coplanarity of this connector is 0.1 mm, but excessive distortion can create solder failure.

* Various factors can contribute to distortion and we recommend an extensive check beforehand.

◆ Stress to the connector

Do not apply any excessive force or mate/unmate these connectors until they are mounted, failure to follow this precaution can lead to deformation or damage to these connectors. Inserting the FPC prior to mounting is not recommended either.

◆ Applied force to the PCB

Do not place any excessive force on the PCB after the connector has been mounted, this type

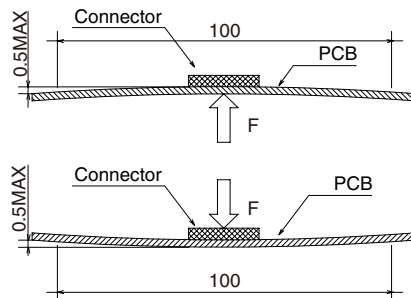

[Precautions when inserting or coupling FPC]

Be careful on the following points when inserting or coupling FPC.

◆ Actuator operation

① Do not apply an excessive amount of force when rotating the actuator or insert your finger nail too far into the structure, this can damage the contacts as shown below.

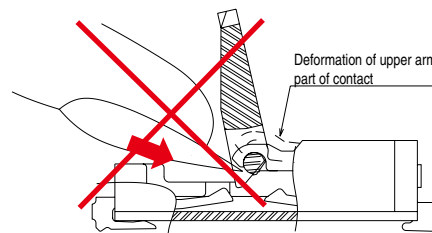
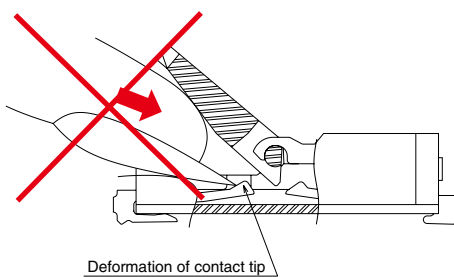

② As depicted below, the actuator was designed to rotate on a rotational axis. The actuator should be operated with this axis in mind.

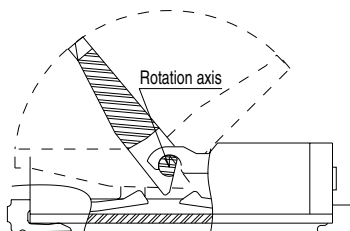

Usage Precautions

- ③ Do not apply a force of 0.5N or more that can press the actuator axis downward, or the actuator may be disengaged or damaged.

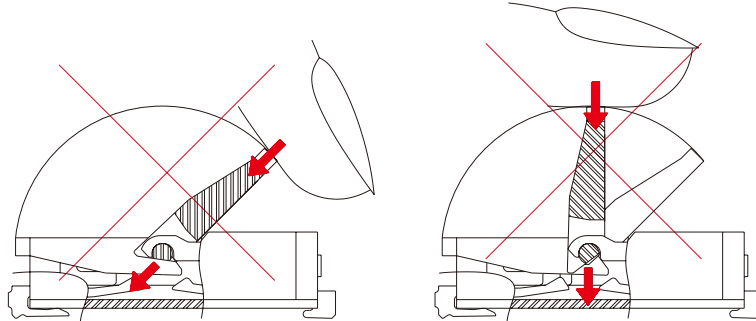

- ④ The actuator is designed to open to a maximum of 135 degrees, trying to open it farther than that will lead to damage or disengagement. The force applied should be less than 1 N. (Refer to the drawing below.)

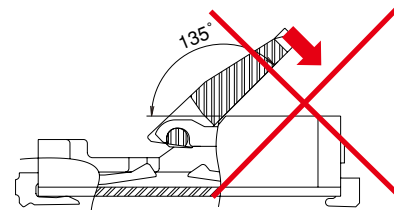

- ⑤ To close and lock the actuator after the FPC has been inserted; apply force on the center of the actuator to engage the lock. Applying pressure to the edges of the actuator might damage or deform the actuator.

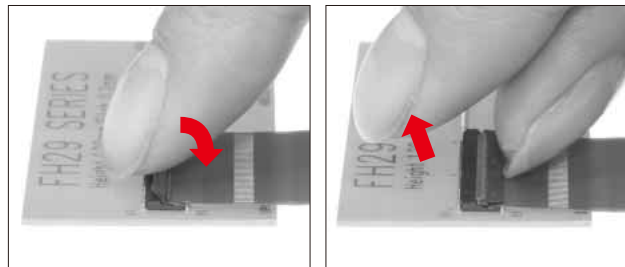

- ⑥ Do not pinch, lift or hook the actuator (as shown below), these actions can damage the connector. (Do not perform any operations other than the rotating operation described in Step ② above.)

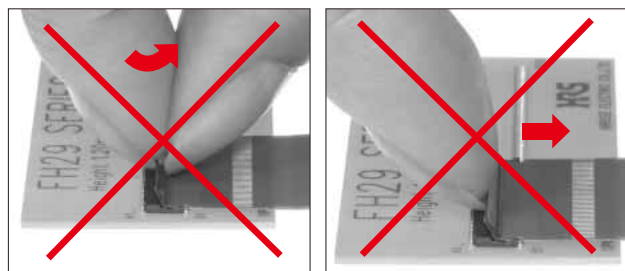

◆ Contact orientation

This is a bottom-contact connector and the FPC should be inserted with the conductive traces facing downward toward the PCB.

◆ FPC insertion

- ① There are FPC alignment tabs that require the FPC to be inserted at a 10 degree angle in respect to the PCB surface but still be perpendicular to the connector. The FPC should be completely inserted into the connector.

An incorrect FPC insertion can damage the contacts and cause the circuit to malfunction.

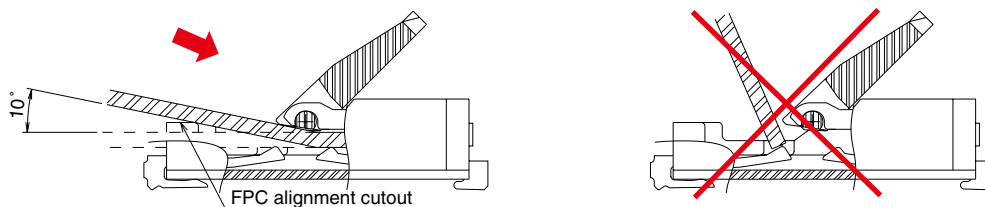

Usage Precautions

- ② Do not insert the FPC at an high angle
As illustrated in the drawing below, if the FPC has been inserted at an high angle, the FPC will bend which can break or damage the conductive traces, or the FPC might not be fully inserted into the connector.

*To avoid this problem, we recommend that consideration be given to insure the proper spacing needed to secure the FPC on the board. The length of the FPC should be considered as well because insertion becomes difficult with FPC that is too short.

* Please contact the FPC/FFC manufacturer for the characteristics of their FPC/FFC.

◆Lock check security

When locking, check that the actuator is level with the PCB surface (see drawing below). When the actuator is positioned close to 0°C, be careful to not apply an excessive load as doing so may deform the contacts. (Load should be less than 1 N.)

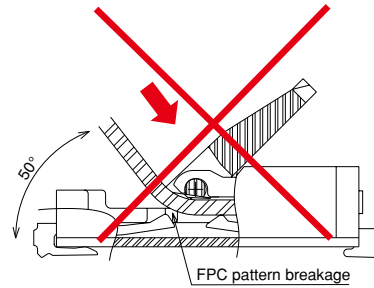

[Precautions when routing FPC after coupling]

◆FPC load

Be cautious of the force applied to the FPC after the actuator has been locked. If there is a large amount of force placed onto the FPC it may release the lock on the connector or damage the FPC. If this load is to be continuous, we recommend that the FPC be secured.

When routing the FPC, make sure that there is not a sharp bend in the FPC especially near the insertion slot.

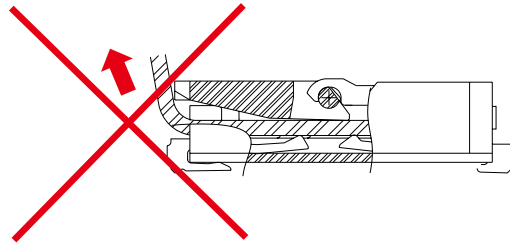

Precautions for FPC removal

◆To release the actuator, rotate it by applying pressure to the center of the actuator.

In case of closing lock while FPC is inserted, operating on the actuator end may cause damages to the actuator.

◆FPC removal should occur only after the actuator has been unlocked

The alignment guides require the FPC to be removed at an angle of about 10° in respect to the PCB surface. If you pull the FPC straight out, or with no angle at all or applying a 5N force, this can damage the FPC alignment cutout.

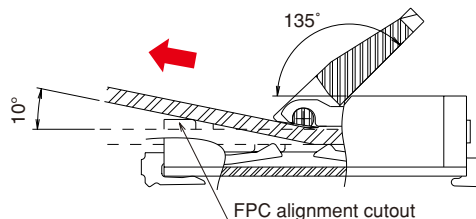
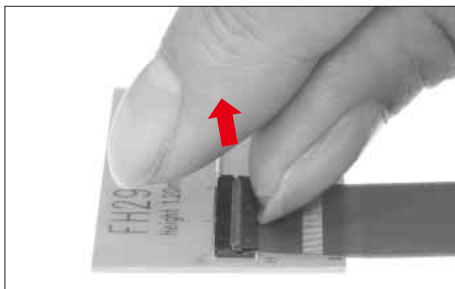

[Other precautions]

◆Hand soldering precautions

When performing hand soldering such as for repair, take care of the following points.

- ① Do not reflow or hand soldering with the FPC inserted into the connector.
- ② Do not apply excessive heat or allow the soldering iron to make contact with anything other than the connector leads. Failure to follow this precaution can lead to a melted or deformed connector.
- ③ Do not apply excessive solder or flux
The use of excessive solder (flux) on the contacts may cause the solder or flux to adhere to the contacts or on the rotational part of the actuator which will result in a poor connection or a potential rotational failure of the actuator.



HIROSE ELECTRIC CO.,LTD.

6-3,Nakagawa Chuoh-2-Chome,Tsuzuki-Ku,Yokohama-Shi 224-8540,JAPAN
TEL: +81-45-620-3526 Fax: +81-45-591-3726
<http://www.hirose.com>
<http://www.hirose-connectors.com>