

Very low capacitance and low leakage current ESD protection

Datasheet – production data

Features

- 2 data-line protection
- Protects V_{BUS}
- Very low capacitance: 2.5 pF typ.
- Very low leakage current:
 - 10 nA at 3 V
 - 1 nA at 1 V
- RoHS compliant

Complies with the following standards:

- IEC 61000-4-2 level 4 and higher:
 - 30 kV (air discharge)
 - 15 kV (contact discharge)
- MIL STD883G-Method 3015-7
 - 25 kV (human body model)

Applications

- USB 2.0 ports up to 480 Mb/s (high speed)
- Compatible with USB 2.0
- Ethernet port: 10/100 Mb/s
- SIM card protection
- Video line protection
- Portable healthcare equipment

Description

The ESDALCL6-2SC6 is a monolithic application specific device dedicated to ESD protection of high speed interfaces, such as USB 2.0, ethernet links and video lines.

The very low line capacitance secures a high level of signal integrity without compromising in protecting sensitive chips against the most stringently characterized ESD strikes.

Its low leakage current makes it suitable for portable equipment.

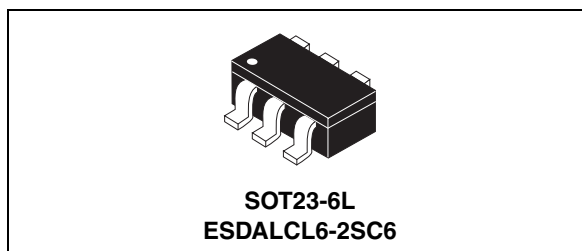
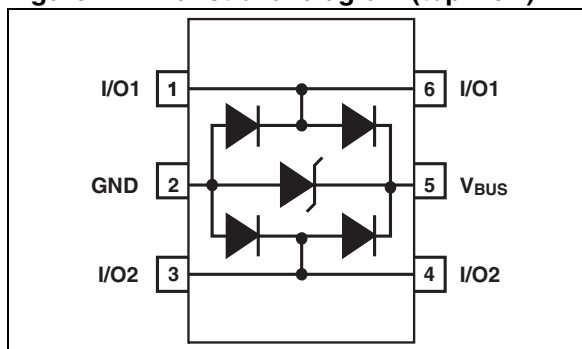

Figure 1. Functional diagram (top view)



1 Characteristics

Table 1. Absolute ratings

| Symbol | Parameter | | Value | Unit |
|------------------|---|---------------------------------|-------------|------|
| V _{PP} | Peak pulse voltage | IEC 61000-4-2 air discharge | 30 | kV |
| | | IEC 61000-4-2 contact discharge | 15 | |
| | | MIL STD883G-Method 3015-7 | 25 | |
| T _{stg} | Storage temperature range | | -55 to +150 | °C |
| T _j | Operating junction temperature range | | -40 to +125 | °C |
| T _L | Lead solder temperature (10 seconds duration) | | 260 | °C |

Table 2. Electrical characteristics (T_{amb} = 25 °C)

| Symbol | Parameter | Test conditions | Value | | | Unit |
|-----------------------|---|--|-------|-------|------|------|
| | | | Min. | Typ. | Max. | |
| V _{BR} | I _R = 1 mA | | 6 | | | V |
| I _{RM} | V _{RM} = 3 V, V _{CC} to GND | | | | 10 | nA |
| | V _{RM} = 1 V, V _{CC} to GND | | | | 1 | |
| V _F | Forward voltage | I _F = 10 mA | | | 1.1 | V |
| V _{CL} | Clamping voltage | I _{PP} = 1 A, 8/20 μs Any I/O pin to GND | | | 12 | V |
| | | I _{PP} = 5 A, 8/20 μs Any I/O pin to GND | | | 17 | V |
| C _{i/o-GND} | Capacitance between I/O and GND | V _R = 1.65 V | | 2.5 | 3.5 | pF |
| ΔC _{i/o-GND} | | | | 0.015 | | |
| C _{i/o-i/o} | Capacitance between I/O | V _R = 1.65 V | | 1.2 | 1.7 | pF |
| ΔC _{i/o-i/o} | | | | 0.04 | | |

Figure 2. Capacitance versus voltage (typical values)

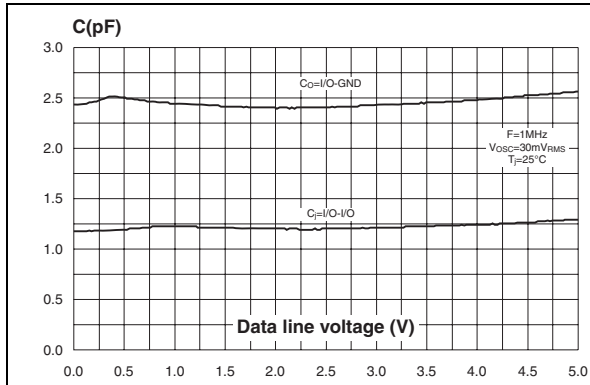

Figure 3. Line capacitance versus frequency (typical values)

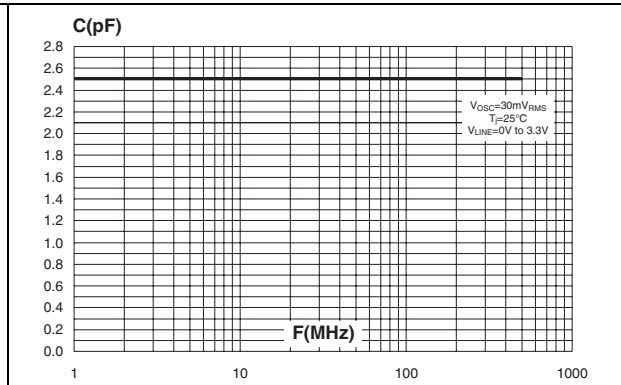

Figure 4. Leakage current versus junction temperature (typical values, $V_R = 1 V$)

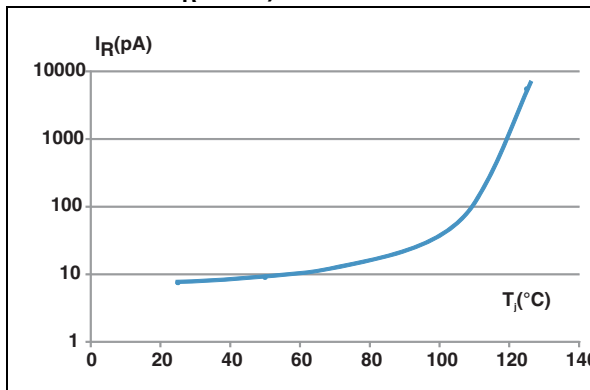

Figure 5. Leakage current versus reverse applied voltage (typical values)

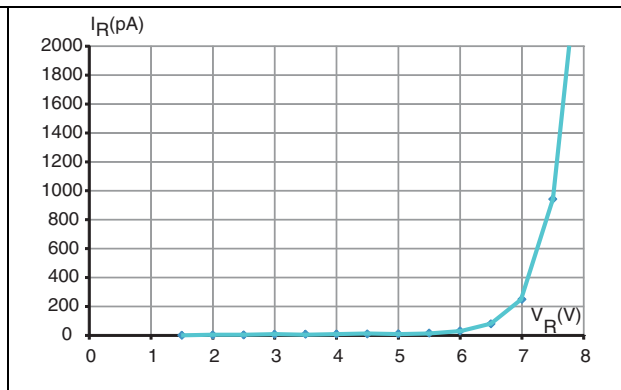

Figure 6. ESD response to IEC 61000-4-2 (+8 kV contact discharge)

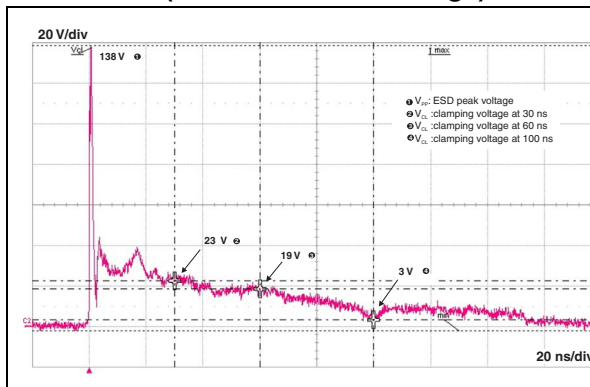

Figure 7. ESD response to IEC 6100-4-2 (-8 kV contact discharge)

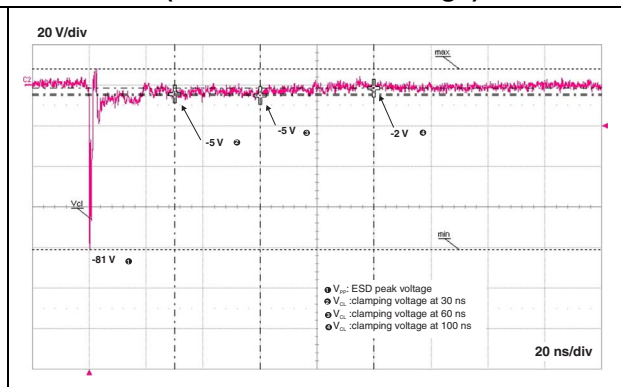

Figure 8. S21 attenuation measurement result

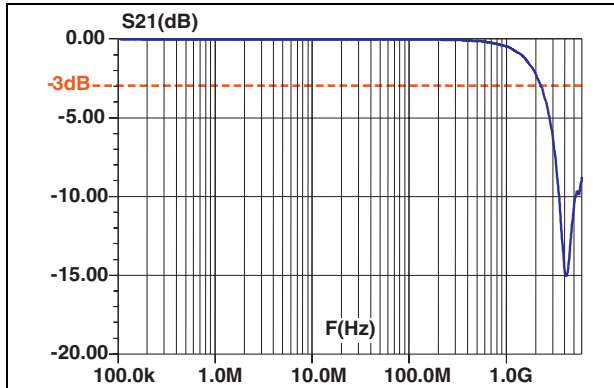
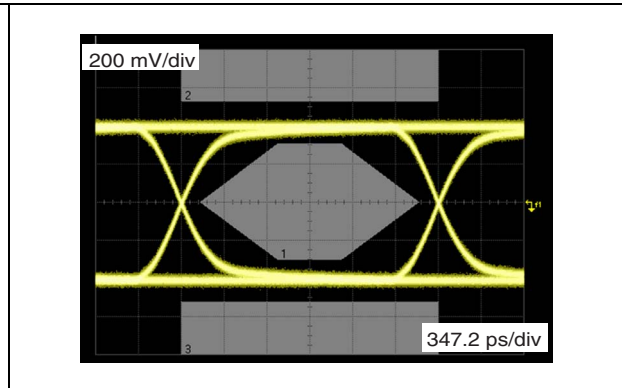
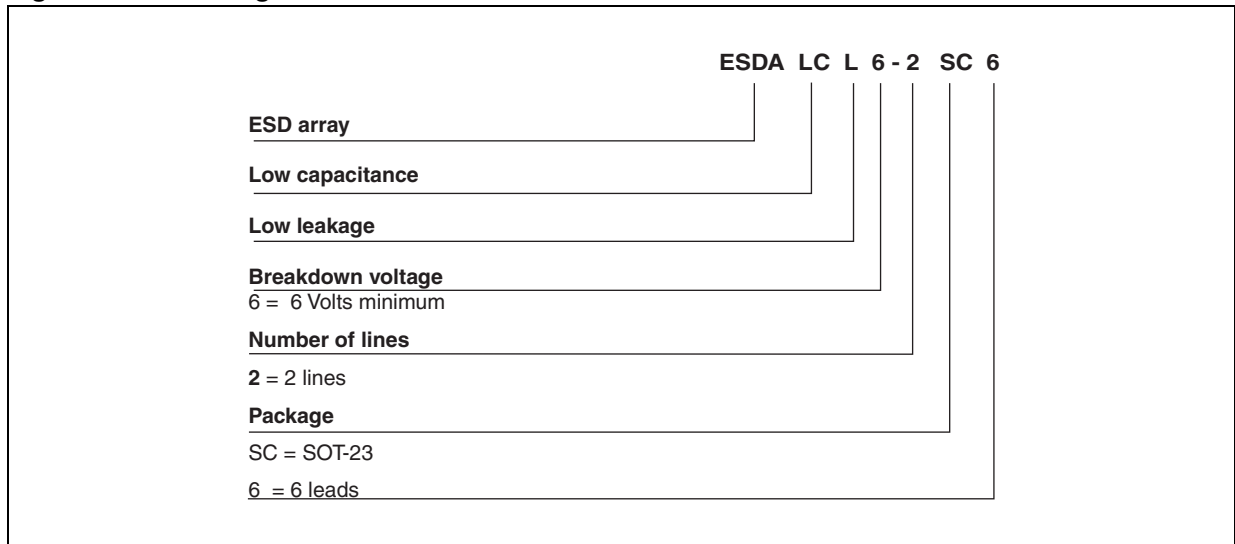

Figure 9. USB2.0 eye diagram



2 Ordering information scheme

Figure 10. Ordering information scheme



3 Package information

- Epoxy meets UL94, V0
- Lead-free packages

In order to meet environmental requirements, ST offers these devices in different grades of ECOPACK® packages, depending on their level of environmental compliance. ECOPACK® specifications, grade definitions and product status are available at: www.st.com. ECOPACK® is an ST trademark.

Table 3. SOT23-6L dimensions

| Ref. | Dimensions | | | | | |
|------|-------------|------|------|--------|-------|-------|
| | Millimeters | | | Inches | | |
| | Min. | Typ. | Max. | Min. | Typ. | Max. |
| A | 0.90 | | 1.45 | 0.035 | | 0.057 |
| A1 | 0 | | 0.15 | 0 | | 0.006 |
| A2 | 0.90 | | 1.30 | 0.035 | | 0.051 |
| b | 0.30 | | 0.50 | 0.012 | | 0.020 |
| c | 0.09 | | 0.20 | 0.004 | | 0.008 |
| D | 2.80 | | 3.05 | 0.11 | | 0.118 |
| E | 1.50 | | 1.75 | 0.059 | | 0.069 |
| e | | 0.95 | | | 0.037 | |
| H | 2.60 | | 3.00 | 0.102 | | 0.118 |
| L | 0.30 | | 0.60 | 0.012 | | 0.024 |
| θ | 0° | | 10° | 0° | | 10° |

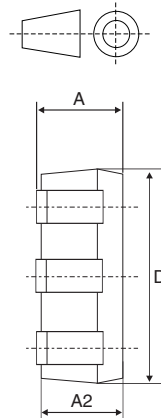
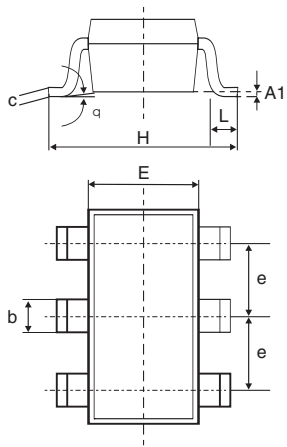
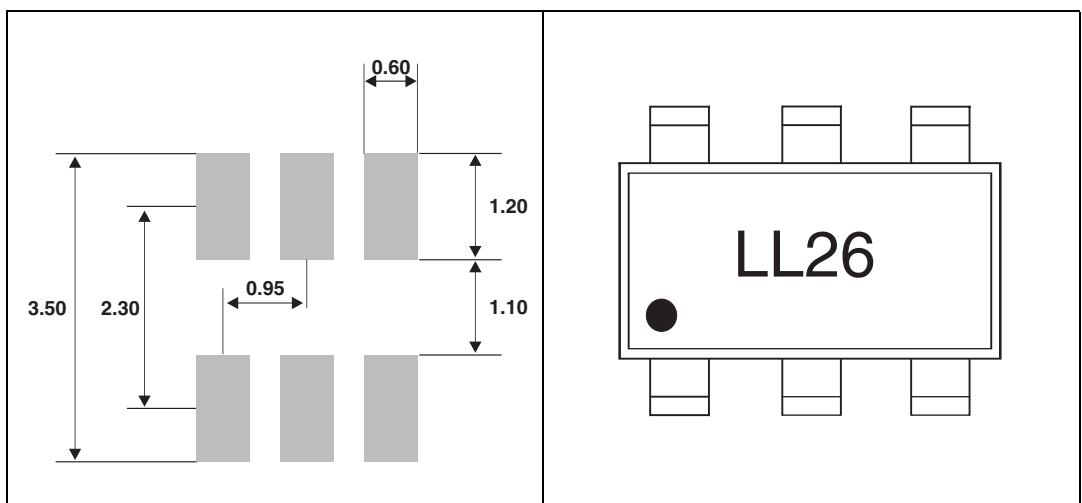

Figure 11. SOT23-6L footprint dimensions in mm

Figure 12. SOT23-6L marking



4 Ordering information

Table 4. Ordering information

| Order code | Marking | Package | Weight | Base qty | Delivery mode |
|---------------|---------|----------|---------|----------|---------------|
| ESDALCL6-2SC6 | LL26 | SOT23-6L | 16.7 mg | 3000 | Tape and reel |

5 Revision history

Table 5. Document revision history

| Date | Revision | Changes |
|-------------|----------|--------------|
| 31-Oct-2012 | 1 | First issue. |

Please Read Carefully:

Information in this document is provided solely in connection with ST products. STMicroelectronics NV and its subsidiaries ("ST") reserve the right to make changes, corrections, modifications or improvements, to this document, and the products and services described herein at any time, without notice.

All ST products are sold pursuant to ST's terms and conditions of sale.

Purchasers are solely responsible for the choice, selection and use of the ST products and services described herein, and ST assumes no liability whatsoever relating to the choice, selection or use of the ST products and services described herein.

No license, express or implied, by estoppel or otherwise, to any intellectual property rights is granted under this document. If any part of this document refers to any third party products or services it shall not be deemed a license grant by ST for the use of such third party products or services, or any intellectual property contained therein or considered as a warranty covering the use in any manner whatsoever of such third party products or services or any intellectual property contained therein.

UNLESS OTHERWISE SET FORTH IN ST'S TERMS AND CONDITIONS OF SALE ST DISCLAIMS ANY EXPRESS OR IMPLIED WARRANTY WITH RESPECT TO THE USE AND/OR SALE OF ST PRODUCTS INCLUDING WITHOUT LIMITATION IMPLIED WARRANTIES OF MERCHANTABILITY, FITNESS FOR A PARTICULAR PURPOSE (AND THEIR EQUIVALENTS UNDER THE LAWS OF ANY JURISDICTION), OR INFRINGEMENT OF ANY PATENT, COPYRIGHT OR OTHER INTELLECTUAL PROPERTY RIGHT.

UNLESS EXPRESSLY APPROVED IN WRITING BY TWO AUTHORIZED ST REPRESENTATIVES, ST PRODUCTS ARE NOT RECOMMENDED, AUTHORIZED OR WARRANTED FOR USE IN MILITARY, AIR CRAFT, SPACE, LIFE SAVING, OR LIFE SUSTAINING APPLICATIONS, NOR IN PRODUCTS OR SYSTEMS WHERE FAILURE OR MALFUNCTION MAY RESULT IN PERSONAL INJURY, DEATH, OR SEVERE PROPERTY OR ENVIRONMENTAL DAMAGE. ST PRODUCTS WHICH ARE NOT SPECIFIED AS "AUTOMOTIVE GRADE" MAY ONLY BE USED IN AUTOMOTIVE APPLICATIONS AT USER'S OWN RISK.

Resale of ST products with provisions different from the statements and/or technical features set forth in this document shall immediately void any warranty granted by ST for the ST product or service described herein and shall not create or extend in any manner whatsoever, any liability of ST.

ST and the ST logo are trademarks or registered trademarks of ST in various countries.

Information in this document supersedes and replaces all information previously supplied.

The ST logo is a registered trademark of STMicroelectronics. All other names are the property of their respective owners.

© 2012 STMicroelectronics - All rights reserved

STMicroelectronics group of companies

Australia - Belgium - Brazil - Canada - China - Czech Republic - Finland - France - Germany - Hong Kong - India - Israel - Italy - Japan - Malaysia - Malta - Morocco - Philippines - Singapore - Spain - Sweden - Switzerland - United Kingdom - United States of America

www.st.com

