

ES-313 ETHERNET TO SERIAL DEVICE SERVER

Ethernet 2 Port RS422/485

CONNECT, CONFIGURE, CONTROL YOUR SERIAL DEVICES



Features

- 2 port RS422/485
- Max baud rate 1,000,000 1 MegaBaud
- 10/100Base TX Ethernet port
- User friendly interface, simple to use, powerful in operation
- Web configuration and RFC2217 compliant interface
- IP-30 rated enclosure
- LED status indication
- Optional DIN rail mounting kit
- Serial Port Tunneling (individually configurable) allows serial cable replacement over any distance, no software required
- Power supply included with screw fix connector (5-30V DC)
- Simple operation for each and every operating system!
- Lifetime Warranty
- Lifetime Support



Description

Ethernet to Serial device server providing access to two RS422/485 serial ports. Data transfer rates up to 1,000,000 baud, coupled with 1Mbit/s line drivers deliver uncompromising performance. Our ES range provides simple instant networked serial ports. RS485 - 1 twisted pair - half duplex configuration with autogating provides trouble free data transmission due to automatic control of data direction. A web interface allows secure configuration and control of the serial ports over a local network or the internet using any browser. For Windows our in-house designed 32 bit and 64 bit driver gives you local COM ports, retaining existing software applications and allowing you to connect across your network to remote devices just as if they were attached locally. Serial Port Tunneling individually configurable allows serial cable replacement over any distance, no software required. You can access the device via TCP/IP sockets from any networked device like an Android tablet, PC or phone. On Windows OS TCP/IP sockets are handled by the Winsock API, this will differ on other OSs.

Windows Users - Our software drivers gives you local COM ports, allowing you to retain your existing software applications and connect to your devices over the network. COM Port can be assigned from COM1 to COM255 and the Brainboxes Ethernet to serial device remembers your COM Port assignment on reboots.

Web Interface Users (Linux/Apple OS/Android) - Alternatively access the device via TCP/IP socket from any networked device. Configure options via web interface.

Extend your reach! Remote serial devices with local control. With Brainboxes industry renowned Lifetime Warranty and Lifetime Support!

Example Application



Box Information

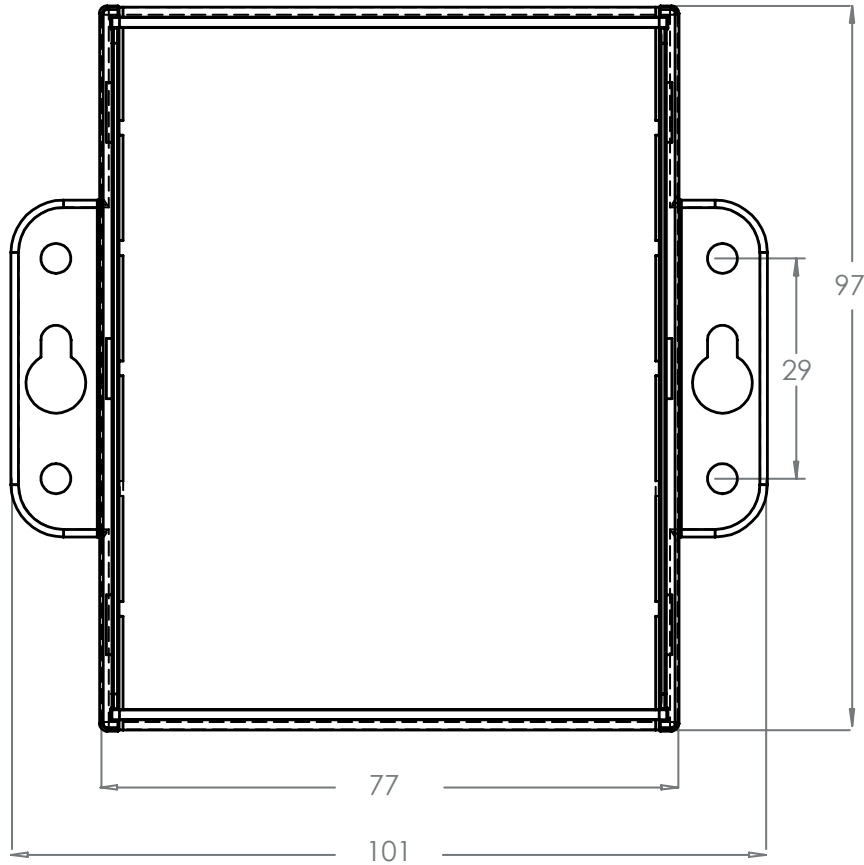

LED Information

Status LED	Green	Device Ready
	Flashing Yellow	Changing Settings
	Flashing between Red & Green	Querying IP
	Flashing Green/Red	User performing Hard Reset
	Flashing between Green & Red/Yellow	IP address diagnostic
	Flashing between Green & Yellow	Initialization diagnostic
Serial Port LEDs	Green light on	Port Open
	Flashing Green	Data RX / TX
Network LED	Green light on	Link Established
	Flashing Green	Data RX / TX

Port

Ports	2 port RS422/485
Connector	DB9 Connector - 9 Pin Male
Power Input	5 - 30V DC input, reverse polarity protected
Power Consumption	1.06W Typical, 2.6W Max

Port Settings - RS422/485

Baud Rate	From 110 - 1,000,000 1 MegaBaud
Data Bits	5,6,7 or 8
Parity	Odd, Even, None, Mark or Space
Stop Bits	1 or 2
Flow Control	RTS/CTS, XON/XOFF
Tx/Rx Modes	<p>RS422 Standard: RS422 allows one transmitter and up to 10 receivers with data transmitter rates up to 10 megabits per second for distances up to 40 feet and up to 100 Kilobits per second for distances up to 4,000 feet (1219 metres).</p> <p>To achieve good long distance noise immunity, 2 wires are used to carry each signal, configured as a twisted pair of cables. The TXD pair and RXD pair are used to carry the data whilst the RTS pair and CTS pair lines are used for handshaking. Thus 2 twisted pairs are used without handshaking and 4 twisted pair cable is used with handshaking both these schemes allow full duplex data communications.</p> <p>RS485 Standard: RS485, based on the RS422 standard allows up to 32 driver/receivers pairs on a standard load or 128 low load devices per port can be connected. Whilst only one of these should be transmitting data at any time, the rest can all simultaneously listen to the data. Handshaking is performed by software protocol. Two twisted pairs form a full duplex system.</p> <p>Often only one twisted pair cable is used as the TXD and RXD lines are tied together; this is known as half duplex mode. Brainboxes RS422/485 products implement a state of the art hardware autogating circuit ensuring error free communications in half duplex configurations.</p>

Port Settings - Ethernet

Data Rate	10/100 Mega bits/second
Cabling	Normal / Crossover auto-sensing (Auto-MDIX)

Environmental

Operating Temperature	0 to 55°C
Storage Temperature	-20 to 85°C
Ambient Relative Humidity	5 to 95% (non-condensing)
Housing	IP-30 rated case

Software

Network Protocols	ICMP, IP, TCP, DHCP, BOOTP, Telnet, HTTP, RFC2217
Configuration Options	Windows Utility, Web Interface
OS Compatibility	Microsoft Windows 7 32 bit 64 bit Editions / Windows Server 2008 32 bit 64 bit Editions / Windows Vista 32 bit 64 bit Editions / Windows Server 2003 32 bit 64 bit Editions / Windows XP 32 bit 64 bit Editions / Microsoft Windows 2000 /Fully RFC2217 compliant / Interface for other OS's & Linux
Connection to Network	Ethernet 10BaseT / 100BaseTX

Approvals

Industry Approvals	AEO C-TPAT Microsoft Certified Gold Partner WEEE RoHS EMC: CE TAA
Microsoft Approvals	Microsoft Certified Gold Partner
Microsoft Signed Drivers	Windows 7 32 bit 64 bit Editions



GB AEOF 00031/11



Packing Information

Packaging	Installation CD including manual, Microsoft signed drivers & utilities
Device	Ethernet 2 Port RS422/485
Accessory Items	Global Power Supply - PW-800 (included), DIN-Rail Mounting Kit - MK-048
Packaged Weight	0.467 kg, 16.47 ounces
Packaged Dims	200x135x80 mm, 7.9x5.3x3.1 inches

Product Support

Warranty	Lifetime - online registration required
Support	Lifetime Web, Email and Phone Support from fully qualified, friendly staff who work in and alongside the Product Development Team



Additional Information

OEM option	Available for bulk buy OEM
Made In	Manufactured in the UK by Brainboxes Winner 2005 European Electronics Industry Awards 'Manufacturer of the Year'
Customisable	Brainboxes operate a 'Perfect Fit Custom Design' policy for volume users. More info: sales@brainboxes.com

Accessory Items

ORDER CODE - DIN-Rail Mounting Kit - MK-048

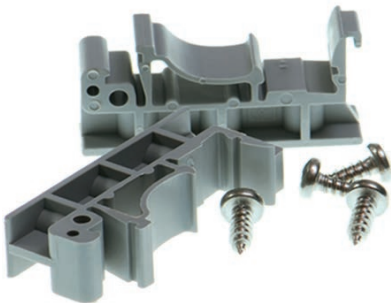

ORDER CODE - Additional Global Power Supply - PW-800



Brainboxes Ethernet to Serial Range