

REV.	ECN NO.	DATE	SIGN	DESCRIPTION
B	LEN-8B0375	2008/09/17	Shin	Add Note

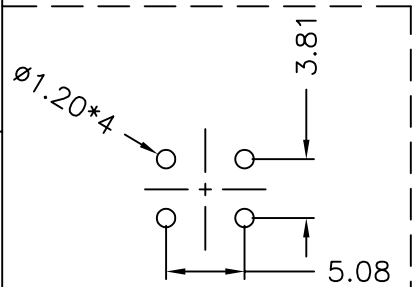

4 Pin Male Connector
Male Pin PCB Layout

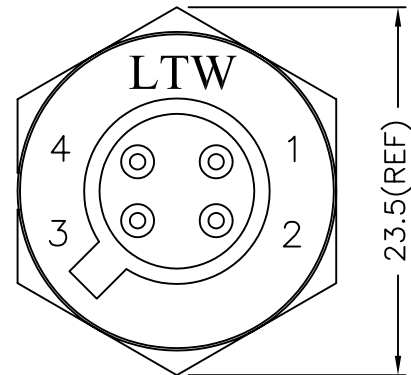
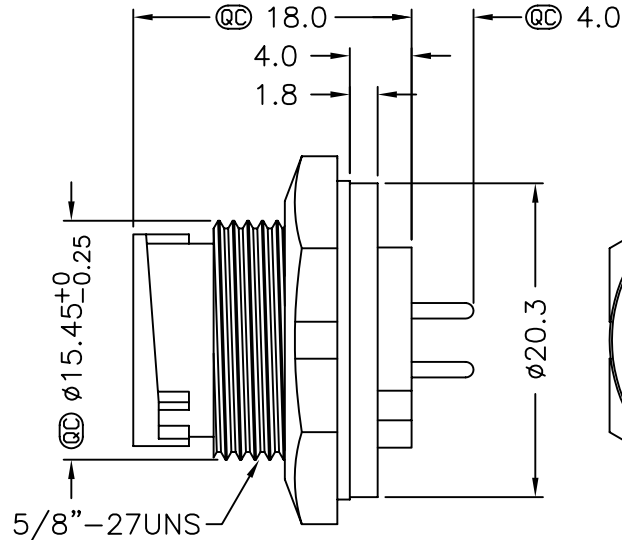
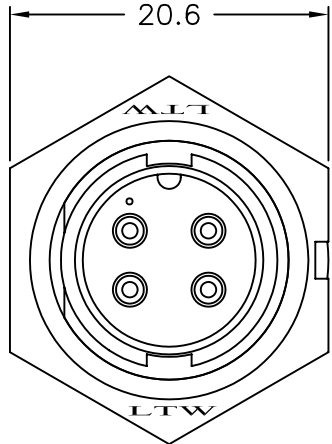
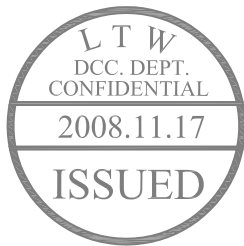
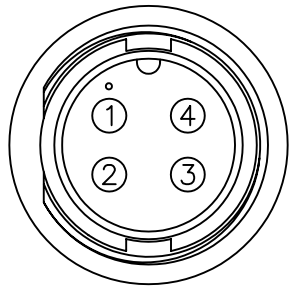

Pin Assignments
Front View

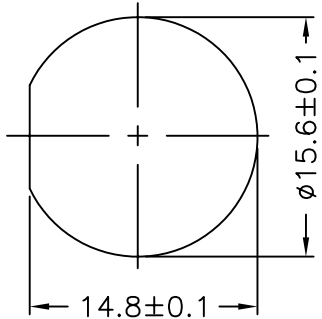

Recommended Panel Cut-out

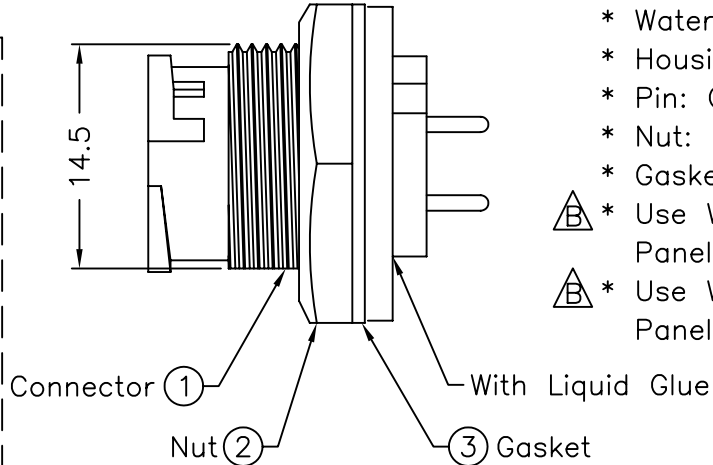

Note:

- * @C Important Dimension To Check.
- * Waterproof Rate: IP67
- * Housing: Black, Nylon+GF
- * Pin: Copper Alloy, Gold Plated
- * Nut: Black, Nylon+GF
- * Gasket: Black, EPDM
- * Use With Waterproof Cap Or Dust Cap
Panel Thickness Max: 3.0mm
- * Use Without Waterproof Cap Or Dust Cap
Panel Thickness Max: 4.5mm

UNIT:mm	
TOLERANCE	
.X	±0.25
.XX	±0.1
.XXX	±0.05
ANGLES	±1°

TITLE		Standard	
Panel Lock 4Pin M Conn M Pin			
SCALE	Free	SHEET	1 OF 1
REV.	B	SIZE	A4
@C :Inspection Item			

LTW
亮泰企業股份有限公司

ITEM NO	LTWBD-04PMMP-LC7001
DWG NO	LTWBD-04PMMP-LC7001
CUSTOMER	

DRAWN BY	Ivan
CHECKED BY	Tommy
APPROVED BY	Luke

DATE	2008/10/30
DATE	2008/10/30
DATE	2008/10/30

THIS DOCUMENT IS SUBJECT TO CHANGE WITHOUT NOTICE. IT IS CONFIDENTIAL AND A PROPERTY OF LTW. DISCLOSURE TO THIRD PARTY HAS TO BE AUTHORIZED BY LTW.