

# Sonic Fast Recovery Diode

High Performance Fast Recovery Diode  
 Low Loss and Soft Recovery  
 Single Diode

$V_{RRM} = 1200\text{ V}$   
 $I_{FAV} = 30\text{ A}$   
 $t_{rr} = 200\text{ ns}$

Part number

**DHG 30 I 1200 HA**

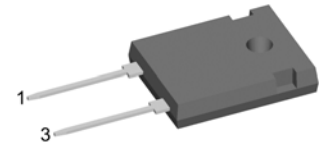
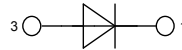

Backside: cathode

**Features / Advantages:**

- Planar passivated chips
- Very low leakage current
- Very short recovery time
- Improved thermal behaviour
- Very low  $I_{rm}$ -values
- Very soft recovery behaviour
- Avalanche voltage rated for reliable operation
- Soft reverse recovery for low EMI/RFI
- Low  $I_{rm}$  reduces:
  - Power dissipation within the diode
  - Turn-on loss in the commutating switch

**Applications:**

- Antiparallel diode for high frequency switching devices
- Antisaturation diode
- Snubber diode
- Free wheeling diode
- Rectifiers in switch mode power supplies (SMPS)
- Uninterruptible power supplies (UPS)

**Package:**

- Housing: TO-247
- Industry standard outline
- Epoxy meets UL 94V-0
- RoHS compliant

**Ratings**

Symbol	Definition	Conditions	Ratings			Unit	
			min.	typ.	max.		
$V_{RRM}$	max. repetitive reverse voltage	$T_{VJ} = 25^\circ\text{C}$			1200	V	
$I_R$	reverse current	$V_R = 1200\text{ V}$			50	$\mu\text{A}$	
		$V_R = 1200\text{ V}$			0.5	mA	
$V_F$	forward voltage	$I_F = 30\text{ A}$	$T_{VJ} = 25^\circ\text{C}$		1.95	2.26	V
						3.00	V
		$I_F = 30\text{ A}$	$T_{VJ} = 125^\circ\text{C}$		1.95	2.27	V
						3.20	V
$I_{FAV}$	average forward current	rectangular $d = 0.5$	$T_C = 90^\circ\text{C}$		30	A	
$V_{F0}$	threshold voltage	} for power loss calculation only	$T_{VJ} = 150^\circ\text{C}$		1.25	V	
$r_F$	slope resistance				30	m $\Omega$	
$R_{thJC}$	thermal resistance junction to case				0.70	K/W	
$T_{VJ}$	virtual junction temperature		-55		150	$^\circ\text{C}$	
$P_{tot}$	total power dissipation				180	W	
$I_{FSM}$	max. forward surge current	$t = 10\text{ ms}$ (50 Hz), sine	$T_{VJ} = 45^\circ\text{C}$		200	A	
$I_{RM}$	max. reverse recovery current		$T_{VJ} = 25^\circ\text{C}$		23	A	
		$I_F = 30\text{ A}; V_R = 600\text{ V}$	$T_{VJ} = 125^\circ\text{C}$		30	A	
			$T_{VJ} = 25^\circ\text{C}$		200	ns	
$t_{rr}$	reverse recovery time	$-di_F/dt = 600\text{ A}/\mu\text{s}$	$T_{VJ} = 125^\circ\text{C}$		350	ns	
			$T_{VJ} = 25^\circ\text{C}$				
$C_J$	junction capacitance	$V_R = 600\text{ V}; f = 1\text{ MHz}$	$T_{VJ} = 25^\circ\text{C}$		11	pF	

Symbol	Definition	Conditions	Ratings			Unit
			min.	typ.	max.	
$I_{RMS}$	RMS current	per terminal			70	A
$R_{thCH}$	thermal resistance case to heatsink			0.25		K/W
$T_{stg}$	storage temperature		-55		150	°C
<b>Weight</b>				6		g
$M_D$	mounting torque		0.8		1.2	Nm
$F_C$	mounting force with clip		20		120	N

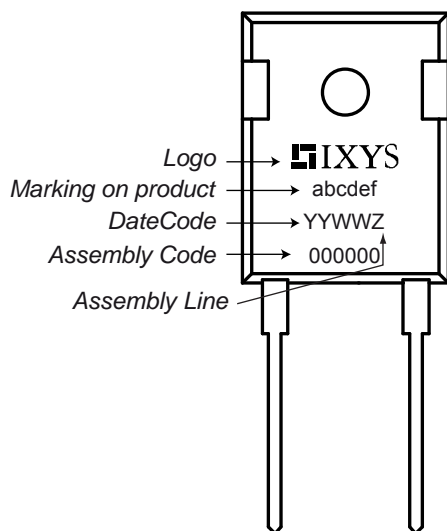
**Product Marking**

**Part number**

- D = Diode
- H = Sonic Fast Recovery Diode
- G = extreme fast
- 30 = Current Rating [A]
- I = Single Diode
- 1200 = Reverse Voltage [V]
- HA = TO-247AD (2)

Ordering	Part Name	Marking on Product	Delivering Mode	Base Qty	Code Key
Standard	DHG 30 I 1200 HA	DHG30I1200HA	Tube	30	503098

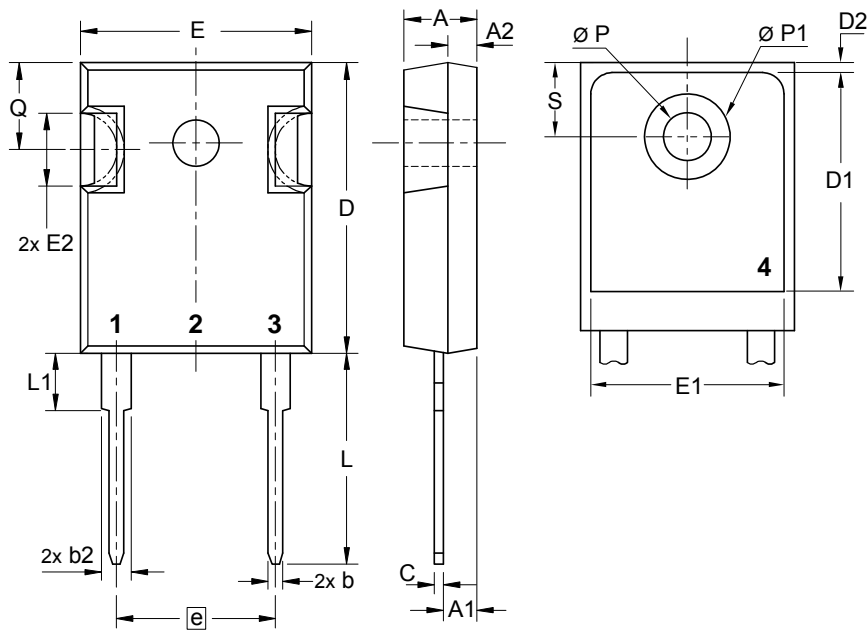
Similar Part	Package	Voltage Class
DSEP30-12A	TO-247AD (2)	1200
DSEP29-12A	TO-220AC (2)	1200
DSEP30-12AR	ISOPLUS247 (2)	1200
DSEP30-12CR	ISOPLUS247 (2)	1200

**Outlines TO-247**

Sym.	Inches		Millimeter	
	min.	max.	min.	max.
A	0.185	0.209	4.70	5.30
A1	0.087	0.102	2.21	2.59
A2	0.059	0.098	1.50	2.49
D	0.819	0.845	20.79	21.45
E	0.610	0.640	15.48	16.24
E2	0.170	0.216	4.31	5.48
e	0.430 BSC		10.92 BSC	
L	0.780	0.800	19.80	20.30
L1	-	0.177	-	4.49
Ø P	0.140	0.144	3.55	3.65
Q	0.212	0.244	5.38	6.19
S	0.242 BSC		6.14 BSC	
b	0.039	0.055	0.99	1.40
b2	0.065	0.094	1.65	2.39
b4	0.102	0.135	2.59	3.43
c	0.015	0.035	0.38	0.89
D1	0.515	-	13.07	-
D2	0.020	0.053	0.51	1.35
E1	0.530	-	13.45	-
Ø P1	-	0.29	-	7.39

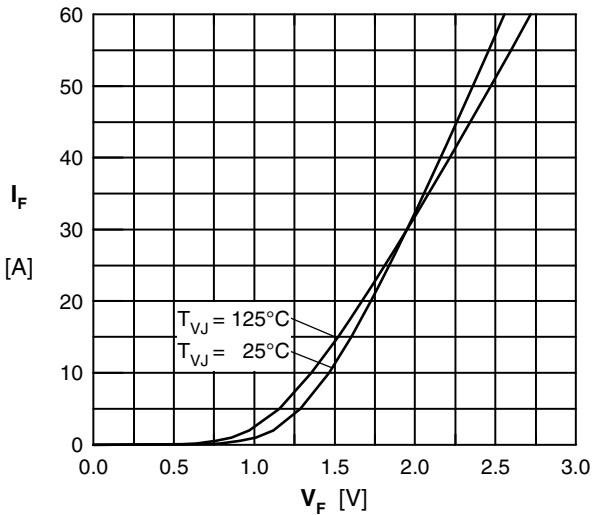

Fig. 1 Typ. Forward current versus  $V_F$

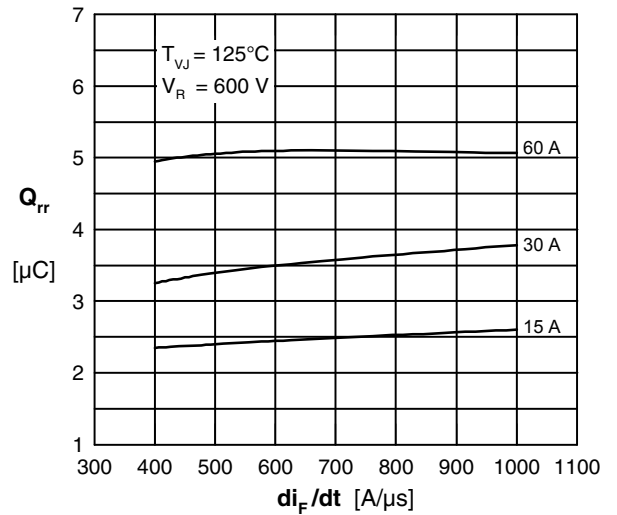

Fig. 2 Typ. reverse recov.charge  $Q_{rr}$  vs.  $di/dt$

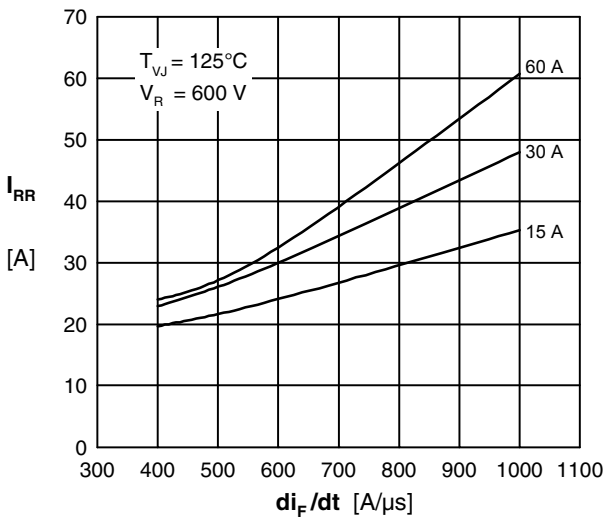

Fig. 3 Typ. peak reverse current  $I_{RM}$  vs.  $di/dt$

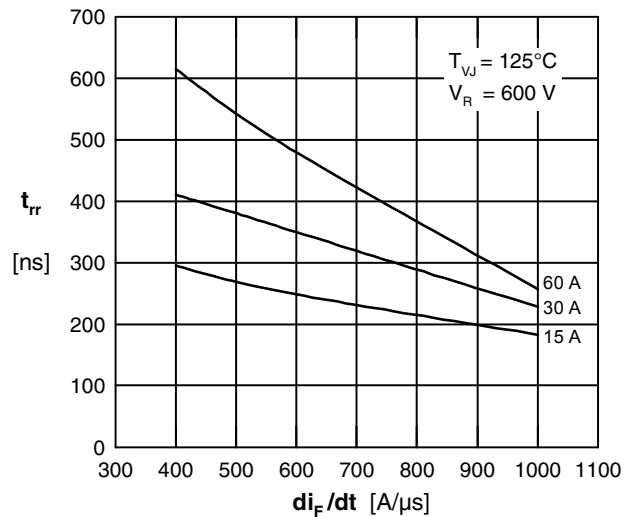

Fig. 4 Typ. recovery time  $t_{rr}$  versus  $di/dt$

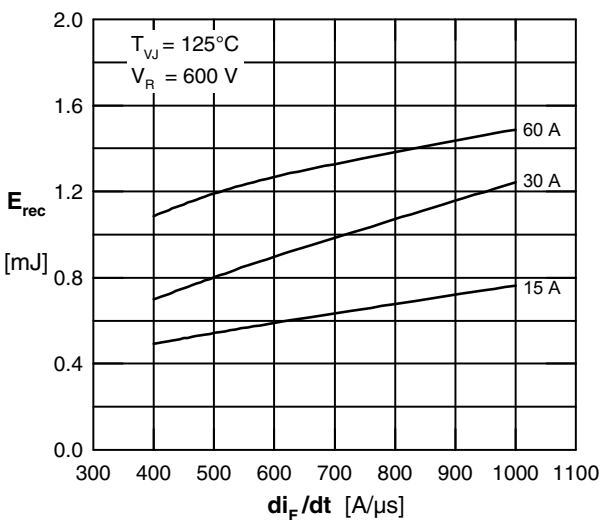

Fig. 5 Typ. recovery energy  $E_{rec}$  versus  $di/dt$

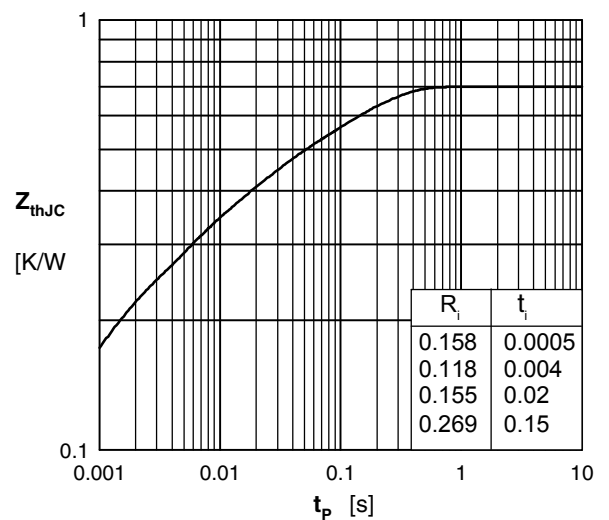

Fig. 6 Transient thermal impedance