



### ■ Features

- Compliance to EN50155 and EN45545-2 railway standard
- Width only 40mm
- 2:1 wide input range
- -40~+70°C wide working temperature
- 150% peak load capability
- Current sharing up to 960W(3+1)
- DC output adjustable
- Cooling by free air convection
- Can be installed on DIN rail TS-35/7.5 or 15
- Protections: Short circuit / Overload / Over voltage / Over temperature / Input reverse polarity/ Input under voltage protection
- 4KVdc I/O isolation(Reinforced isolation)
- DC OK relay contact
- Remote ON-OFF control
- 3 years warranty

### ■ Applications

- Bus, tram, metro or railway system
- Industrial control system
- Semi-conductor fabrication equipment
- Factory automation
- Electro-mechanical
- Wireless network
- Telecom or datacom system

### ■ Description

DDR-240 series is a 240W DIN Rail type DC-DC converter with main features including DIN rail-type easy installation, ultra slim width (40mm), 2:1 wide input voltage, fanless design, -40~+70°C wide operating temperature, 4KVdc I/O isolation, 150% peak load, current sharing, DC OK, adjustable output voltage and full protective functions. This series of models has various input options: 16.8~33.6V / 33.6~67.2V / 67.2~154V and two output options: 24V / 48V and can be used for industrial & railway control, security control, communication system and other fields. Suitable applications include to DC buck/boost regulator, increasing system insulation level and voltage drop compensation along cable...etc.

### ■ Model Encoding

**DDR - 240 B - 24**

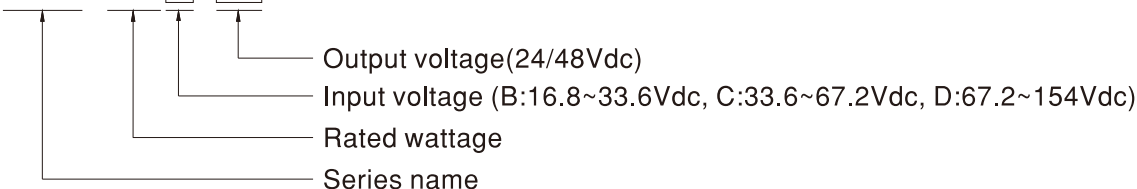

## SPECIFICATION

MODEL		DDR-240B-24	DDR-240B-48	DDR-240C-24	DDR-240C-48	DDR-240D-24	DDR-240D-48	
OUTPUT	DC VOLTAGE	24V	48V	24V	48V	24V	48V	
	RATED CURRENT	10A	5A	10A	5A	10A	5A	
	CURRENT RANGE	0 ~ 10A	0 ~ 5A	0 ~ 10A	0 ~ 5A	0 ~ 10A	0 ~ 5A	
	RATED POWER	240W	240W	240W	240W	240W	240W	
	PEAK	CURRENT	15A	7.5A	15A	7.5A	15A	7.5A
		POWER <small>Note.5</small>	360W (3sec.)					
	RIPPLE & NOISE (max.) <small>Note.2</small>	80mVp-p		100mVp-p		80mVp-p		100mVp-p
	VOLTAGE ADJ. RANGE	24 ~ 28V		48 ~ 56V		24 ~ 28V		48 ~ 56V
	VOLTAGE TOLERANCE <small>Note.3</small>	± 1.0%		± 1.0%		± 1.0%		± 1.0%
	LINE REGULATION	± 0.5%		± 0.5%		± 0.5%		± 0.5%
LOAD REGULATION	± 1.0%		± 1.0%		± 1.0%		± 1.0%	
SETUP, RISE TIME	500ms, 60ms							
HOLD UP TIME (Typ.)	6ms@24Vdc			8ms@48Vdc		11ms@110Vdc		
INPUT	VOLTAGE RANGE <small>Note.4</small>	CONTINUOUS	16.8 ~ 33.6Vdc		33.6 ~ 67.2Vdc		67.2 ~ 154Vdc	
		100ms	14.4 ~ 16.8Vdc		28.8 ~ 33.6Vdc		66 ~ 67.2Vdc	
	EFFICIENCY (Typ.)	90%		91%		92%		
	DC CURRENT (Typ.)	11.2A @24Vdc		5.6A @48Vdc		2.5A @110Vdc		
	INRUSH CURRENT (Typ.)	30A						
INTERRUPTION OF VOLTAGE SUPPLY	S2 (EN 50155 5.1.1.2) ; B/C-type comply with S2 level (10ms)@ 70% load ; D-type comply with S2 level (10ms)@ full load							
PROTECTION	OVERLOAD <small>Note.5</small>	Normally works within 150% rated output power for more than 3 seconds and then constant current protection 105~ 135% rated output power with auto-recovery						
	OVER VOLTAGE	28.8 ~ 35V	57.6 ~ 65.0V	28.8 ~ 35V	57.6 ~ 65V	28.8 ~ 35V	57.6 ~ 65V	
		Protection type : Shut down o/p voltage, re-power on to recover						
	OVER TEMPERATURE	Shut down o/p voltage, re-power on to recover						
UNDER VOLTAGE LOCKOUT	24Vin (B - type) :Power ON ≥ 16.8V , OFF ≤ 16.5V		48Vin (C - type) :Power ON ≥ 33.6V , OFF ≤ 33V		110Vin (D - type):Power ON ≥ 67.2V , OFF ≤ 65V			
FUNCTION	DC OK REALY CONTACT RATINGS (max.)	30Vdc/1A resistive load						
	CURRENT SHARING	Up to 960W (3+1 units). Please refer to the Function Manual						
	REMOTE ON-OFF CONTROL	Please refer to the Function Manual						
ENVIRONMENT	WORKING TEMP.	-40 ~ +70°C (Refer to "Derating Curve")						
	WORKING HUMIDITY	5 ~ 95% RH non-condensing						
	STORAGE TEMP., HUMIDITY	-40 ~ +85, 5 ~ 95% RH non-condensing						
	TEMP. COEFFICIENT	± 0.03%/°C (0 ~ 55°C )						
	VIBRATION	Component:10 ~ 500Hz, 5G 10min./1cycle, 60min. each along X, Y, Z axes; Mounting: Compliance to IEC61373						
OPERATING ALTITUDE <small>Note.7</small>	2000 meters							
SAFETY & EMC (Note 6)	SAFETY STANDARDS	IEC 62368-1 (LVD, except for 67.2~154Vin), EAC TP TC 004 approved; Design refer to UL508						
	WITHSTAND VOLTAGE	I/P-O/P:4KVdc I/P-FG:2.5KVdc O/P-FG:0.71KVdc						
	ISOLATION RESISTANCE	I/P-O/P, I/P-FG, O/P-FG:>100M Ohms / 500Vdc / 25°C / 70% RH						
	EMC EMISSION	Parameter	Standard			Test Level / Note		
		Conducted	EN55032			Class B		
		Radiated	EN55032			Class B		
		Voltage Flicker	EN61000-3-3			----		
		Harmonic Current	----			-----		
	EMC IMMUNITY	En55024 , EN61000-6-2(EN50082-2)						
		Parameter	Standard			Test Level / Note		
ESD		EN61000-4-2			Level 3, 8KV air ; Level 3, 6KV contact; criteria A			
Radiated		EN61000-4-3			Level 3, 10V/m ; criteria A			
EFT / Burst		EN61000-4-4			Level 3, 2KV ; criteria A			
Surge		EN61000-4-5			Level 3, 1KV/Line-Line ;Level 3, 2KV/Line-Line-FG ;criteria A			
Conducted		EN61000-4-6			Level 3, 10V ; criteria A			
Magnetic Field	EN61000-4-8			Level 4, 30A/m ; criteria A				
RAILWAY STANDARD	Compliance to EN45545-2 for fire protection ; Meet EN50155 / IEC60571 including IEC61373 for shock & vibration, EN50121-3-2 for EMC							
OTHERS	MTBF	484.9K hrs min. Telcordia SR-332 (Bellcore) ; 189.9K hrs min. MIL-HDBK-217F (25°C)						
	DIMENSION	40*125.2*113.5mm (W*H*D)						
	PACKING	0.76Kg;20psc/16.2Kg/1.16CUFT						
NOTE	<p>1. All parameters NOT specially mentioned are measured at normal input (B:24Vdc , C:48Vdc , D:110Vdc ) , rated load and 25°C of ambient temperature.</p> <p>2. Ripple &amp; noise are measured at 20MHz of bandwidth by using a 12" twisted pair-wire terminated with a 0.1 μ f &amp; 47 μ f parallel capacitor.</p> <p>3. Tolerance : includes set up tolerance, line regulation and load regulation.</p> <p>4. Derating may be needed under low input voltage. Please check the derating curve for more details.</p> <p>5. 3 seconds max., please refer to peak loading curves.</p> <p>6. The power supply is considered as an independent unit, but the final equipment still need to re-confirm that the whole system complies with the EMC directives. For guidance on how to perform these EMC tests, please refer to "EMI testing of component power supplies." (as available on <a href="http://www.meanwell.com">http://www.meanwell.com</a>)</p> <p>7. The ambient temperature derating of 3.5°C/1000m with fanless models and of 5°C/1000m with fan models for operating altitude higher than2000m(6500ft).</p>							

### Block Diagram

fosc : 80KHz

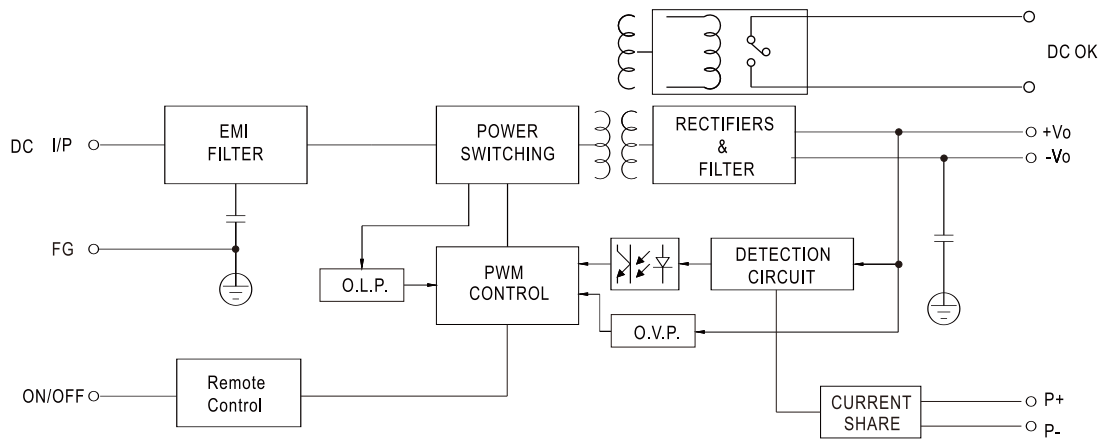

### Derating Curve

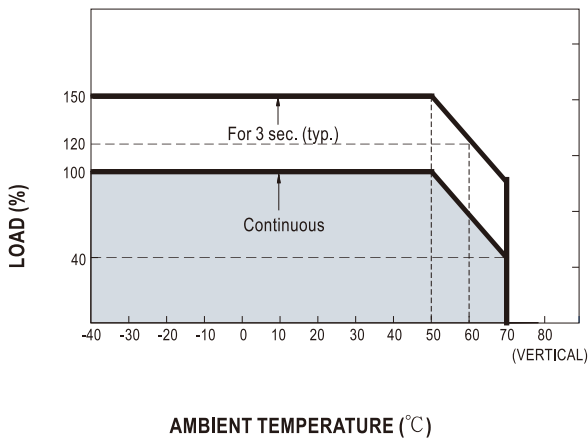

### Output derating VS input voltage

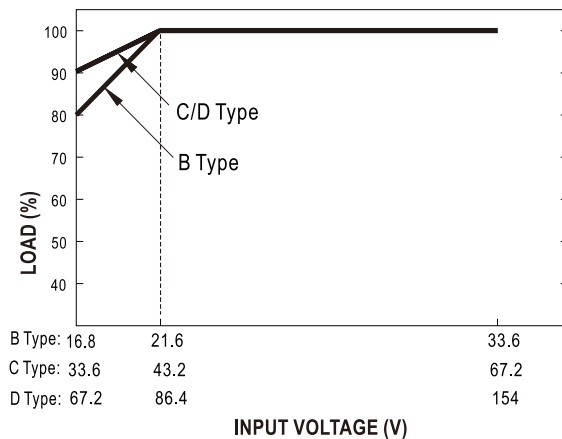

### Peak Loading

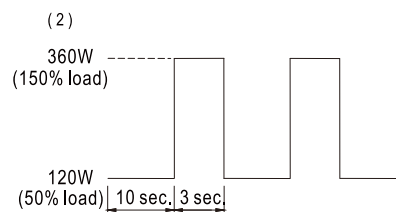
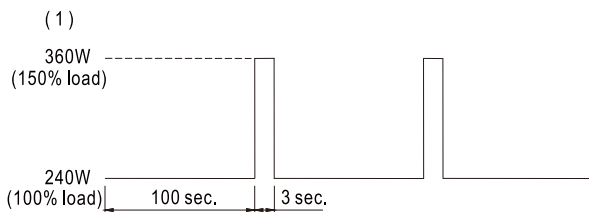

**DC OK Relay Contact**

Contact Close	PSU turns on / DC OK.
Contact Open	PSU turns off / DC Fail.
Contact Ratings (max.)	30V/1A resistive load.

**Function Manual**

**1. Current sharing**

- (1) Parallel operation is available by connecting the units shown as below (P+,P- are connected mutually in parallel) :
- (2) The voltage difference among each output should be minimized that less than 0.2V is required.
- (3) The total output current must not exceed the value determined by the following equation (Output current at parallel operation)  
 =(The rated current per unit) x (Number of unit) x 0.9.
- (4) In parallel operation 4 units is the maximum, please consult the manufacture for other applications.
- (5) When in parallel operation, the minimum output load should be greater than 3% of total output load.  
 (Min. load > 3% rated current per unit x number of unit)

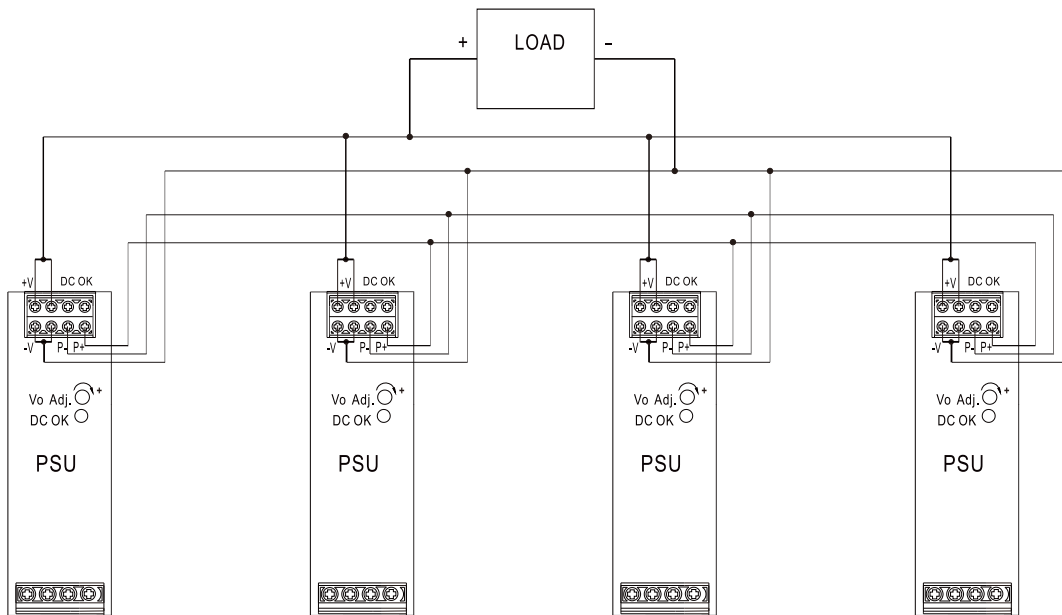

**2. Remote ON-OFF Control**

※ The power supply can be turned ON-OFF by using the "Remote ON-OFF" function.

Remote ON-OFF (TB1 PIN2,4)	Output Status
Open or 4 ~ 10VDC	power supply ON
Short or 0 ~ 0.8VDC	power supply OFF

## Input Fuse

There is one fuse connected in series to the positive input line, which is used to protect against abnormal surge. Fuse specifications of each model are shown as below.

Type	Fuse Type	Reference and Rating
B	Time-Lag	Conquer MST, 10A, 250V *2
C	Time-Lag	Conquer MST, 6.3A, 250V *2
D	Time-Lag	Conquer MST, 6.3A, 250V *1

## Input Under-Voltage Protection

If input voltage drops below  $V_{imin}$ , the internal control IC shuts down and there is no output voltage. It recovers automatically when input voltage reaches above  $V_{imin}$ , please refer to the curve below.

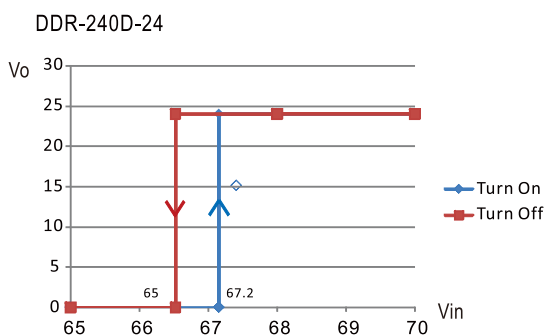
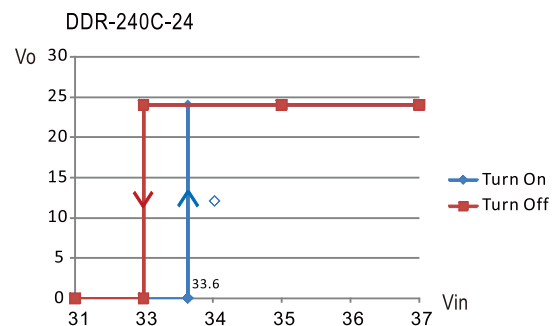
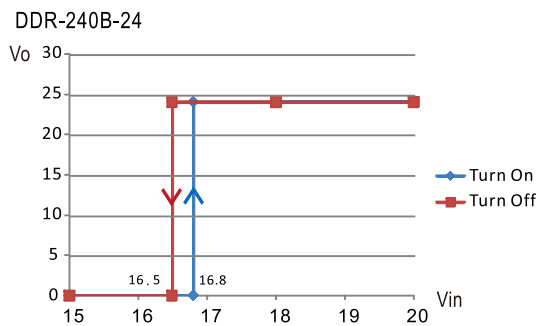

## Input Reverse Polarity Protection

There is a MOSFET connected in series to the negative input line. If the input polarity is connected reversely, the MOSFET opens and there will be no output to protect the unit.

## Inrush Current

Inrush current is suppressed by a resistor during the initial start-up, and then the resistor is bypassed by a MOSFET to reduce power consumption after accomplishing the start-up.

■ **Hold-up Time**

Please refer to the table and curves show below for the hold up time specification.

Model \ Load	100% load	70% load	other load
B type (24Vin)	6ms min.	10ms min.	figure 1,2
C type (48Vin)	8ms min.	11ms min.	figure 3,4
D type (110Vin)	11ms min.	15ms min.	figure 5,6

DDR-240B-24

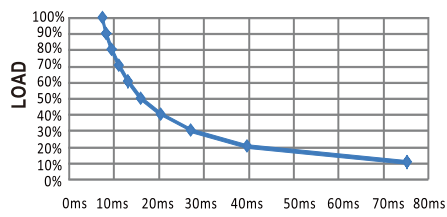

TIME  
(figure 1)

DDR-240B-48

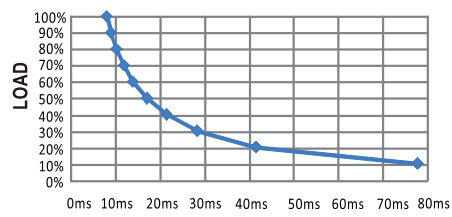

TIME  
(figure 2)

DDR-240C-24

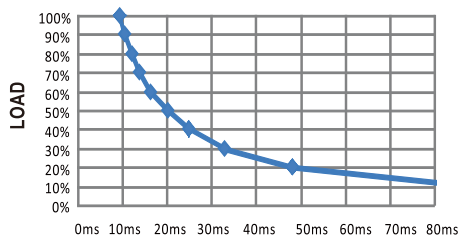

TIME  
(figure 3)

DDR-240C-48

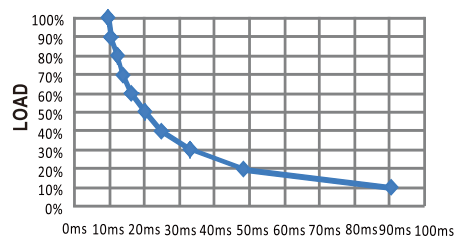

TIME  
(figure 4)

DDR-240D-24

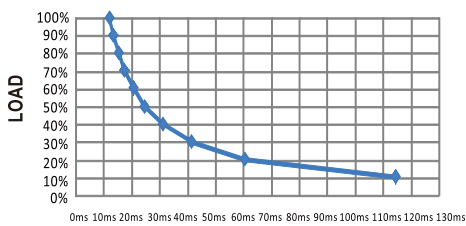

TIME  
(figure 5)

DDR-240D-48

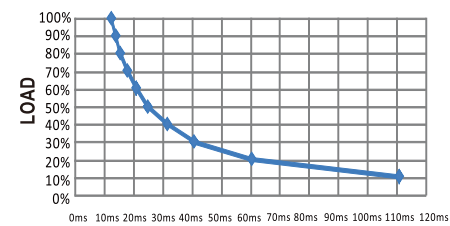

TIME  
(figure 6)

## Efficiency vs Load & Vin Curve

The efficiency vs load & Vin curves of each model are shown as below.

DDR-240B-24

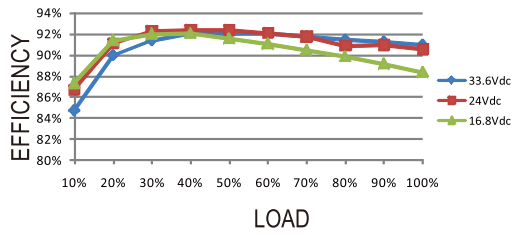

DDR-240B-48

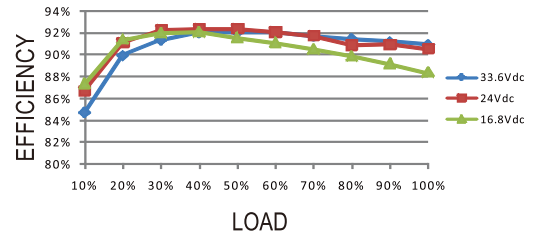

DDR-240C-24

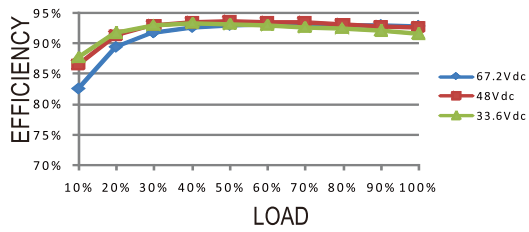

DDR-240C-48

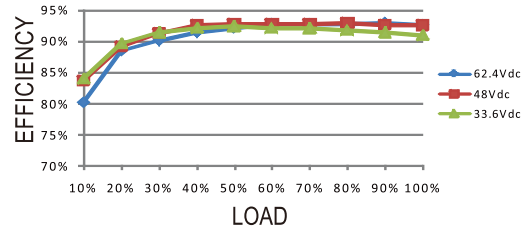

DDR-240D-24

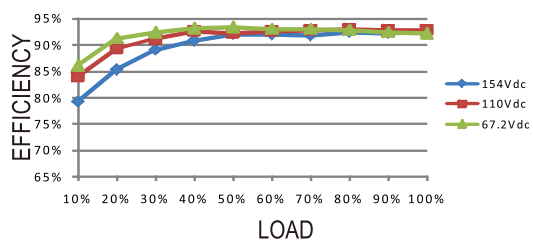

DDR-240D-48

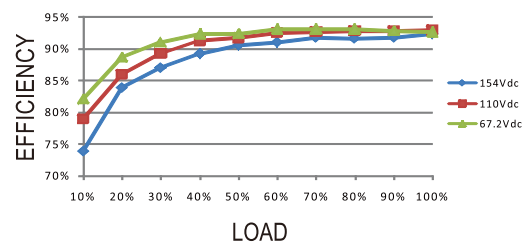

**Immunity to Environmental Conditions**

Test method	Standard	Test conditions	Status
Cooling Test	EN 50155 section 12.2.3 (Column 2, Class TX) EN 60068-2-1	Temperature: -40°C Dwell Time: 2 hrs/cycle	No damage
Dry Heat Test	EN 50155 section 12.2.4 (Column 2, Class TX) EN 50155 section 12.2.4 (Column 3, Class TX & Column 4, Class TX) EN 60068-2-2	Temperature: 70°C / 85°C Duration: 6 hrs / 10min	PASS
Damp Heat Test, Cyclic	EN 50155 section 12.2.5 EN 60068-2-30	Temperature: 25°C~55°C Humidity: 90%~100% RH Duration: 48 hrs	PASS
Vibration Test	EN 50155 section 12.2.11 EN 61373	Temperature: 19°C Humidity: 65% Duration: 10 mins	PASS
Increased Vibration Test	EN 50155 section 12.2.11 EN 61373	Temperature: 19°C Humidity: 65% Duration: 5 hrs	PASS
Shock Test	EN 50155 section 12.2.11 EN 61373	Temperature: 21 ± 3°C Humidity: 65 ± 5% Duration: 30ms*18	PASS
Low Temperature Storage Test	EN 50155 section 12.2.3 (Column 2, Class TX) EN 60068-2-1	Temperature: -40°C Dwell Time: 16 hrs	PASS
Salt Mist Test	EN 50155 section 12.2.10 (Class ST4)	Temperature: 35°C ± 2°C Duration: 96 hrs	PASS

**EN45545-2 Fire Test Conditions**

Test Items		Hazard Level			
	Items	Standard	HL1	HL2	HL3
R22	Oxygen index test	EN 45545-2:2013 EN ISO 4589-2:1996	PASS	PASS	PASS
	Smoke density test	EN 45545-2:2013 EN ISO 5659-2:2006	PASS	PASS	PASS
	Smoke toxicity test	EN 45545-2:2013 NF X70-100:2006	PASS	PASS	PASS
R24	Oxygen index test	EN 45545-2:2013 EN ISO 4589-2:1996	PASS	PASS	PASS
R25	Glow-wire test	EN 45545-2:2013 EN 60695-2-11:2000	PASS	PASS	PASS
R26	Vertical flame test	EN 45545-2:2013 EN 60695-11:2003	PASS	PASS	PASS



## Mechanical Specification

Case No.265A-D Unit:mm

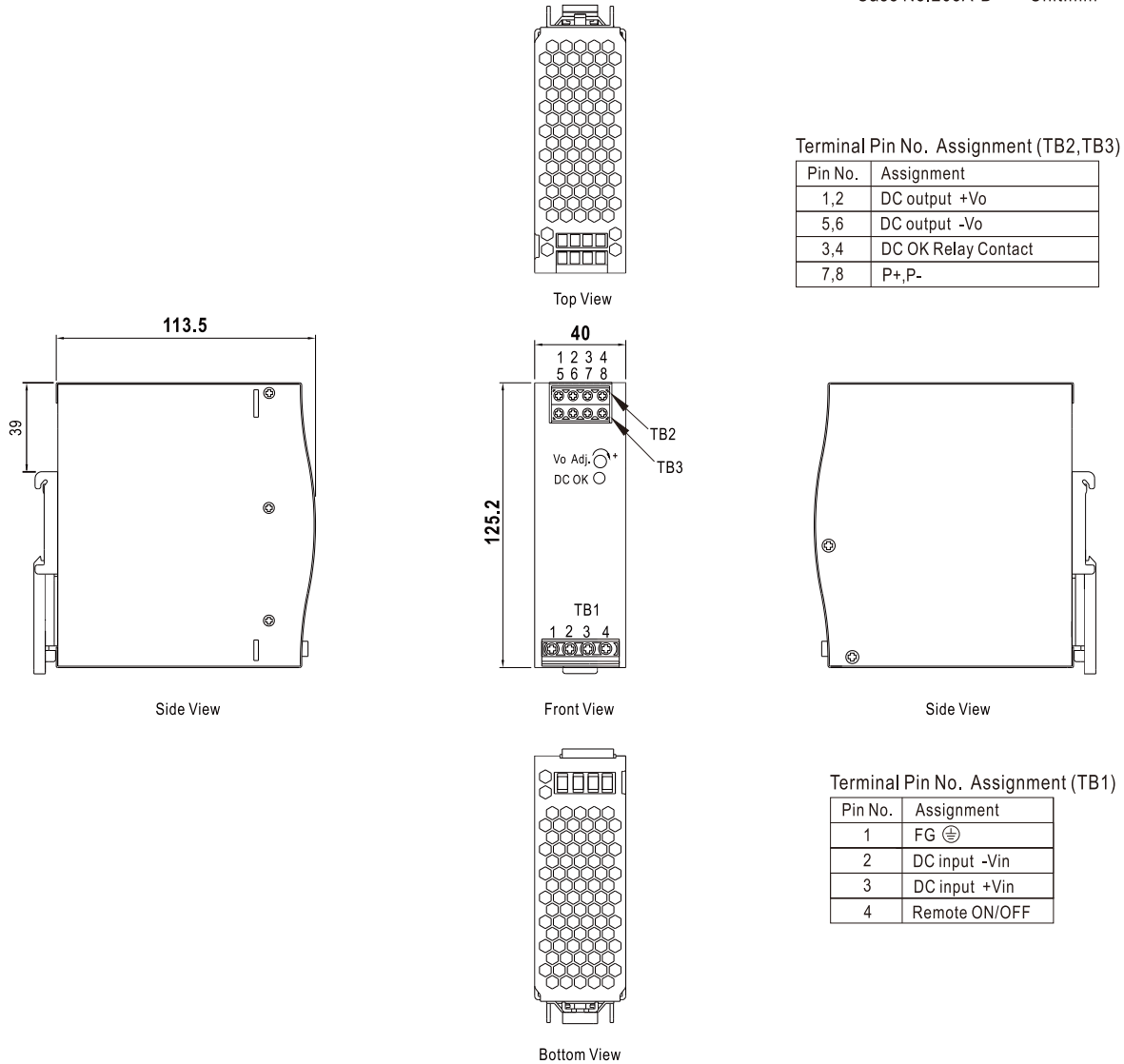

## Installation Instruction

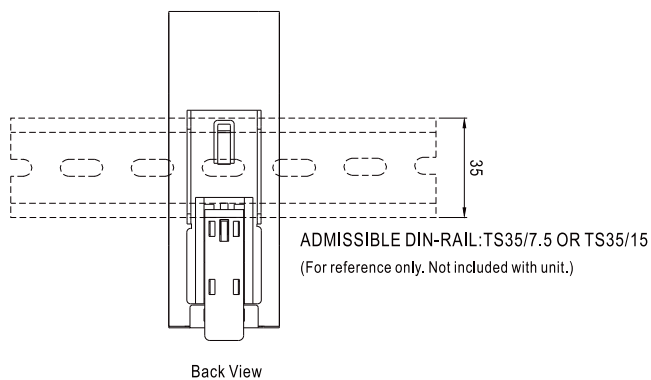

This series fits DIN rail TS35/7.5 or TS35/15.  
For installation details, please refer to the Instruction manual.

## Installation Manual

Please refer to : <http://www.meanwell.com/manual.html>