

CPX Programmable pressure switch for OEM applications

OEM applications

Excellent price/performance ratio

Measurement of vacuum, absolute or gauge pressure

Two threshold outputs: PNP transistors

Windows programming software

Compact and lightweight

Robust stainless steel construction

CE conformitij

The CPX digital pressure switch is designed for extremely diverse OEM pressure applications.

Based on microprocessor technology, the CPX is fully programmable via serial link (RS232) from a PC. The graphics software allows easy user setting of switching points and threshold states.

OEM markets: production machine equipment, rail-vehicles, hydraulic and pneumatic units, compressors, presses, lifting devices, agricultural machinery, water treatment and distribution, etc.



CPX standard version
M12-5 output, 2 thresholds



CPX with DIN 43650 connector
output, 1 threshold

Specifications (20°C)

Measurement range	Absolute pressure: 0...1 to 0...60 bar Gauge pressure: -1...0 to 0...600 bar	Protection rating (EN 60 529)	IP67, M12-5 version IP65, DIN 43650 version
Power supply voltage <i>option</i>	11 to 40 VDC, unregulated <i>High voltage up to 48 Vdc. Code 2180</i> Polarity reversion protection Short-circuit protection	Typical response time of threshold outputs	≤ 50 ms
Power consumption	3 mA for a power supply voltage of 24 VDC	Vibration resistance (EN 60068-2-6)	1.5 mm (10 Hz ... 55 Hz) / 20 g (55 Hz ... 2 kHz)
Switching capacity	400 mA max (M12 version) 800 mA max (DIN 43650 version)	Shock resistance (EN 60028-2-32)	25 falls from 1 m onto concrete floor
Conformity	EMC Directive 89/336 EC Pressure Equipment Directive 97/23/EC	Weight	M12-5 version: 140 g. DIN 43650 connector version: 150 g
Threshold accuracy	±0.5% of F.S. (with reference to BFSL)	Options	
Repeatability	± 0.2% of F.S.	M 12 - 5-pin mobile plug, screw terminal connection. Code 2260	
Threshold setting range	from 2% to 98% of F.S.	M 12 - 5-pin mobile plug + 2-metre cable. Code 2267	
Operating temperature	Ambient temperature: - 20 ... + 80°C Fluid temperature: - 20 ... + 100°C Storage temperature: - 30 ... + 85°C	M 12 - 5-pin mobile plug + 5-metre cable. Code 2269	
Compensated temperature range	-10...+55°C. <i>Option -10...+70°C. Code 2158</i>	M 12 - 5-pin mobile plug + 10-metre cable. Code 2236	
Thermal drift	zero: ± 0.025% F.S./°C max Sensitivity: ± 0.025% F.S./°C max	Other hydraulic and electrical connections on request.	
Materials in contact with the fluid	Ceramic, stainless steel 1.4404 (316 L), NBR seal (standard)		
Connections	Electrical: standard M 12-5 contacts plug (2 thresholds) DIN 43650 connector (1 threshold). Code 2171 Hydraulic: G 1/4 EN837, G 1/4 DIN 3852-E, G 1/2 EN837, 1/4 NPT, 1/2 NPT		

 Baumer

Programming

SoftLink programming software allows the user to configure the following parameters:

- Threshold 1 : High and low switching set-point
- Threshold 2*: High and low switching set-point
- Threshold state for pressure below the lower set point:
Normally Open NO or Normally Closed NC
- Threshold time-delay:
0 ms, 50 ms, 100 ms, 200 ms, 500 ms, 1 s, 2 s ou 5 s
- Customer identifier

* only version with M12 - 5-pin electrical output

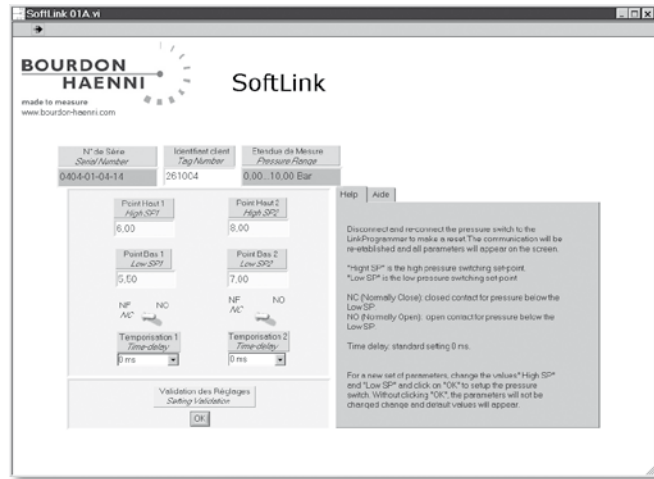

Programming tools

To configure the CPX, the user must connect the Bourdon-Haenni interface via the RS232 cable to the PC communication port.

Baumer complete configuration kit: LinkProgrammer.
LinkProgrammer for CPX with M12-5 output (standard) : **Code LPGR1**
LinkProgrammer for CPX with DIN 43650 output : **Code LPGR2**

The LinkProgrammer is delivered with its carrying case.

The kit contains:

- RS232 communication interface. **Code LPG1**
- Mains power supply (220 VAC / 24 VDC). **Code LPG2**
- SoftLink programme on CD-ROM. **Code LPG3**
- RS232 cable. **Code LPG4**
- Connection cable to CPX, M12-5 connector (LPGR1 kit). **Code LPG5**
- or Connection cable to CPX, DIN 43650 connector (LPGR2 kit). **Code LPG6**

Note: each part of the kit can be ordered separately using dedicated codes.

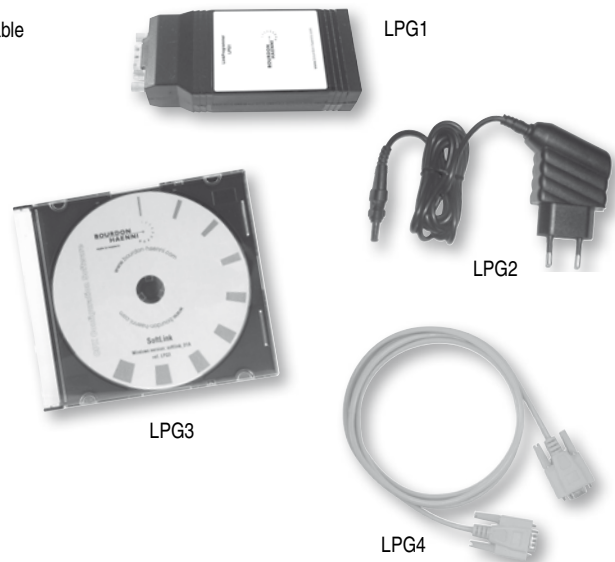

Dimensions (mm), connections

M 12 - 5 contacts plug (standard version)

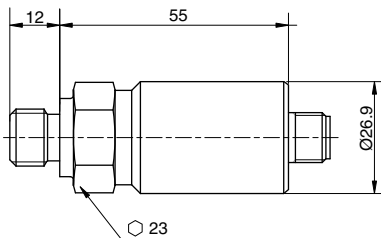

1	+ power supply
2	Threshold 2 output
3	- power supply
4	Threshold 1 output
5	ground



DIN 43650 connector (**Code 2171**)

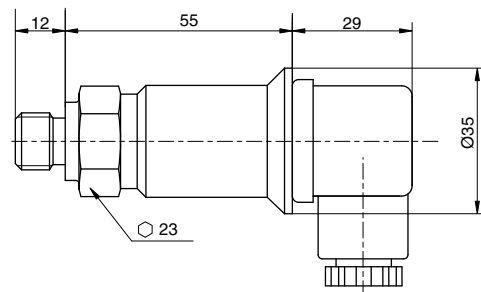

1	+ power supply
2	- power supply
3	Threshold output
⊥	ground

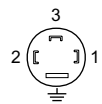

Pressure connections

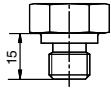

G 1/4 DIN 3852-E

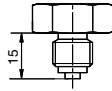

G 1/4 EN837

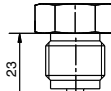

G 1/2 EN837

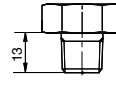

1/4 NPT EN837

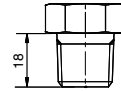

1/2 NPT EN837

Connection diagrams

M 12 - 5 contacts plug (standard version)

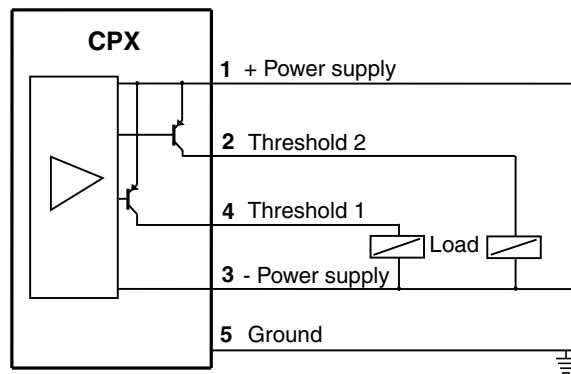

DIN 43650 connector (**Code 2171**)

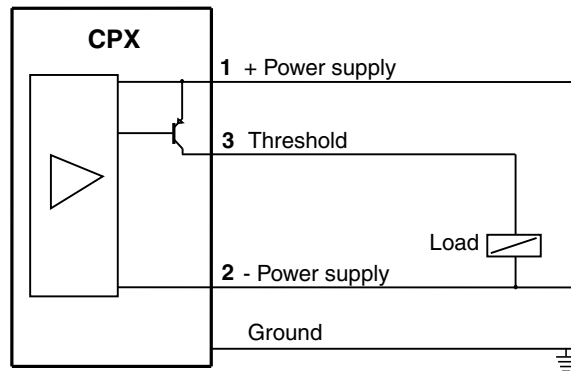

Measuring ranges (bar)

Ranges	Vacuum and Pressure	-1 +0	-1 +0.6	-1 +1.5	-1 +3	-1 +5	-1 +9	-1 +15	-1 +24	-1 +39	-	-	-	-	-	
	Pressure	1	1.6	2.5	4	6	10	16	25	40	60	100	160	250	400	600
	Maximum overpressure	3	3	4	8	12	20	32	50	80	120	200	320	500	600	800
	Burst pressure	6	6	7	12	18	30	48	75	120	180	300	480	600	800	1000

Ordering details - CPX

CPXxxxxxxx	
Type OEM pressure switch, stainless steel construction	1'...3' Digit CPX
Hydraulic connection G1/4 EN837 G1/4 DIN 3852-E G1/2 1/4 NPT 1/2 NPT	4' Digit 2 B 3 5 6
Sensor seal NBR (Nitril) standard EPDM FKM (Viton®)	5' Digit 3 5 9
Pressure range Bar kPa kg/cm ² psi	6'...8' Digit Bxx Dxx Fxx Hxx
Pressure mode Absolute Gauge	9' Digit A R
Setting Without setting With factory setting	10' Digit 0 1
Option Version with DIN 43650 electrical connection (1 threshold only): code 2171 (please add after CPX codification)	

code	Bar kg/cm ²	kPa	code	Psi	A - R
59	-1 + 0	-1 + 0	59	-30°Hg + 0	- R
72	-1 + 0,6	-1 + 60	73	-30°Hg + 15	- R
74	-1 + 1,5	-1 + 150	75	-30°Hg + 30	- R
76	-1 + 3	-1 + 300	2C	-30°Hg + 60	- R
77	-1 + 5	-1 + 500	78	-30°Hg + 100	- R
79	-1 + 9	-1 + 900	79	-30°Hg + 150	- R
81	-1 + 15	-1 + 1500	81	-30°Hg + 220	- R
82	-1 + 24	-1 + 2400	82	-30°Hg + 300	- R
1L	-1 + 39	-1 + 3900	1L	-30°Hg + 600	- R
15	0 + 1	0 + 100	15	0 + 15	A R
16	0 + 1,6	0 + 160	1C	0 + 20	A R
18	0 + 2,5	0 + 250	17	0 + 30	A R
19	0 + 4	0 + 400	19	0 + 60	A R
20	0 + 6	0 + 600	21	0 + 100	A R
22	0 + 10	0 + 1000	22	0 + 160	A R
24	0 + 16	0 + 1600	23	0 + 200	A R
26	0 + 25	0 + 2500	25	0 + 300	A R
27	0 + 40	0 + 4000	26	0 + 400	A R
29	0 + 60	0 + 6000	27	0 + 600	A R
31	0 + 100	0 + 10000	30	0 + 1000	A R
33	0 + 160	0 + 16000	31	0 + 1500	A R
35	0 + 250	0 + 25000	34	0 + 3000	A R
38	0 + 400	0 + 40000	38	0 + 6000	A R
39	0 + 600	0 + 60000	40	0 + 10000	A R

Factory setting

Parameters to be filled in by user if factory setting is required:

	High switching set-point	Low switching set-point	NO or NC	Threshold time-delay 0 / 50 / 100 / 200 / 500 ms 1 s / 2 s / 5 s
Threshold 1				
Threshold 2*				

* only standard M12 - 5 contacts plug version

Curve showing change of threshold state

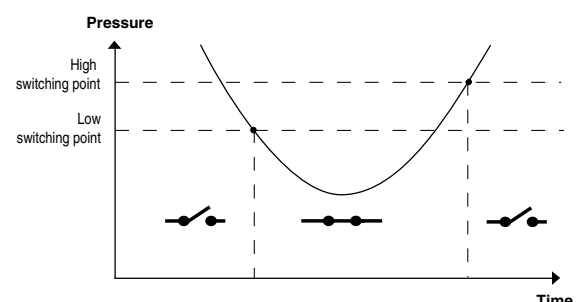
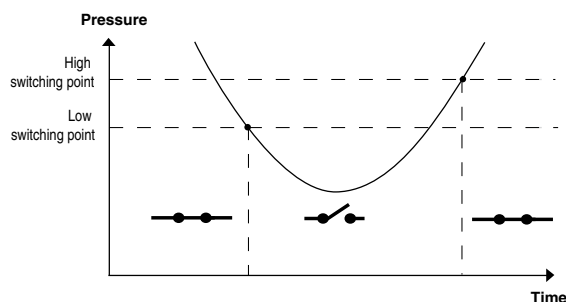
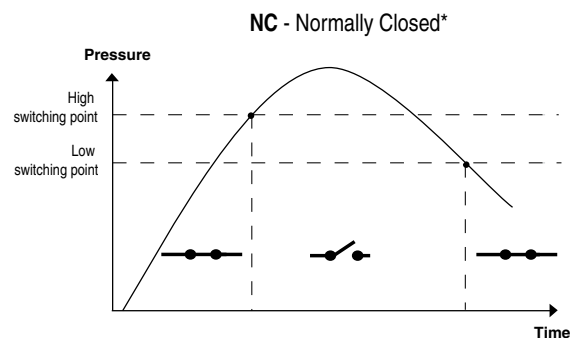
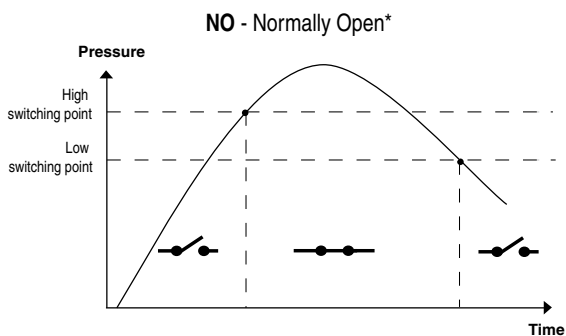

* threshold state for pressure below the lower set point.