



CORNER14 EF/TY

ANGULAR PROFILE 30°/60°

PROFIL KĄTOWY 30°/60°

- decorative and lighting profile
- hidden mountings
- two lighting angles: 30°/60°
- maximum LED strip width: 14 mm
- profil dekoracyjno-oświetleniowy
- ukryte mocowania
- dwa kąty świecenia: 30°/60°
- maksymalna szerokość taśmy LED: 14 mm



SIMILAR IN THE OFFER / PODOBNE W OFERCIE



TRIO10
BC



CORNER10
BC/UX



QUARTER10
BD/U6



CABI12
E



CORNER27
G/UX



CORNER14 EF/TY

- E** slide cover
klosz E wsuwany
- F** click cover
klosz F klik
- Y**¹ Y flexible mounting plate
uchwyt Y sprężysty
- Y**² cone Y flexible mounting plate
uchwyt Y sprężysty cone
- T** mounting plate
uchwyt T

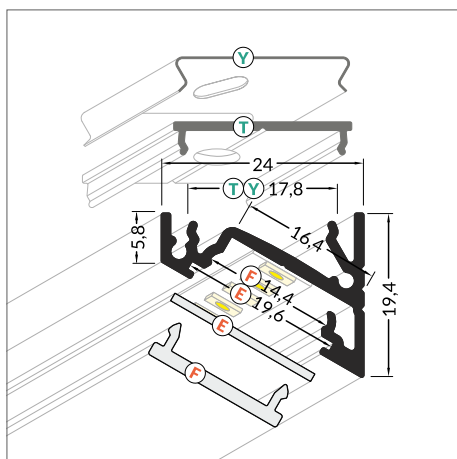
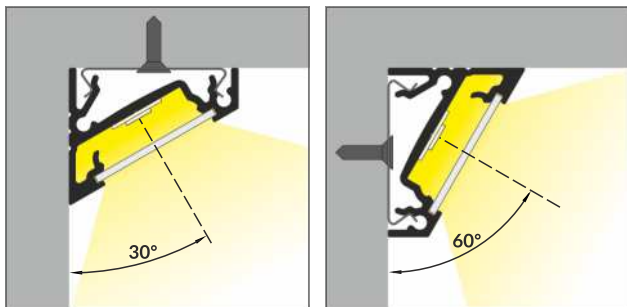
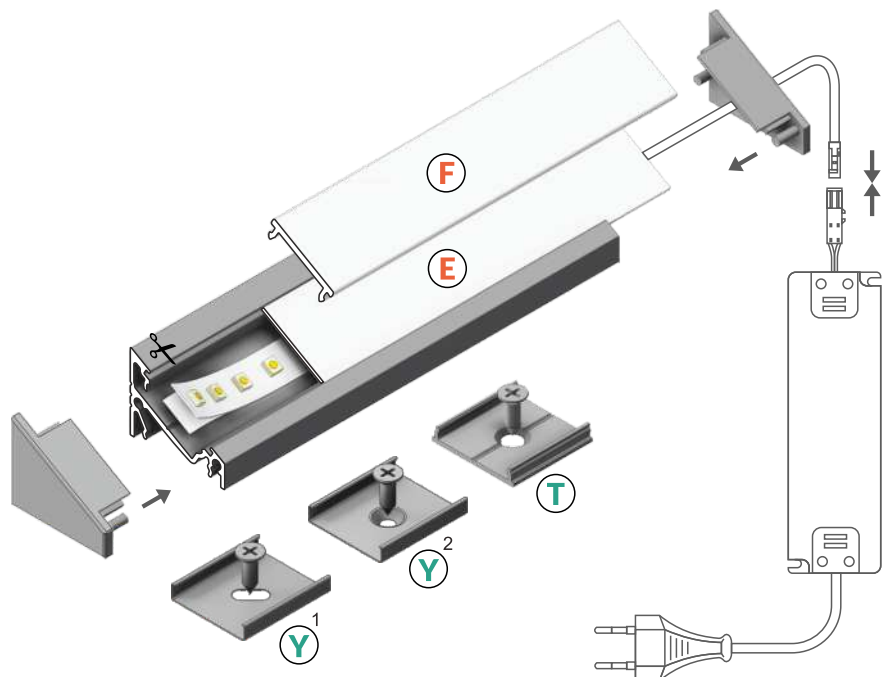

INDEX = 1 pc, length 2000 mm
package = 10 pcs
INDEKS = 1 szt., długość 2000 mm
opakowanie = 10 szt.

 white painted
biały malowany
A4020001

 anodized
anodowany
A4020020

 black anodized
czarny anodowany
A4020021

 raw aluminium
surowe aluminium
A4020000

Available lengths / Dostępne długości
1000 mm, 2000 mm, 3000 mm, 4000 mm



COVERS / KLOSZE

E slide cover

colours: transparent, frosted, white
material: PC, PP, PP

klosz E wsuwany
kolory: transparentny, szron, mleczny
materiał: PC, PP, PP



Note! Dimensions of the space to install LED source
Uwaga! Wymiary przestrzeni do zamontowania źródła LED

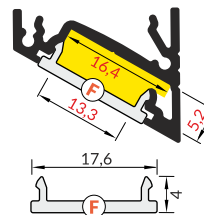
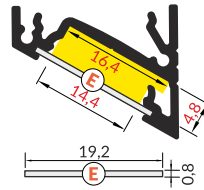

F click cover

colours: transparent, white
material: PMMA

klosz F klik
kolory: transparentny, mleczny
materiał: PMMA

E7 click cover
colour: white
material: PMMA

klosz E7 klik
kolor: mleczny
materiał: PMMA

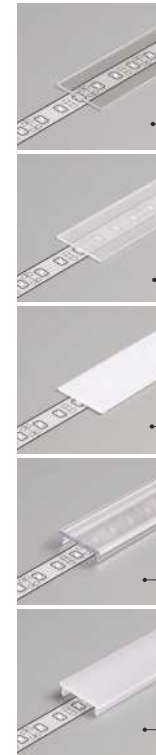
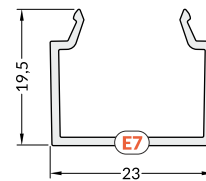

INDEX = 1 pc, length 2000 mm
package = 10 pcs
INDEKS = 1 szt., długość 2000 mm
opakowanie = 10 szt.

E transparent / E transparentny
A2040016

E frosted / E szron
A2040039

E white / E mleczny
A2040038

F transparent / F transparentny
A2060016

F white / F mleczny
A2060038

E7 white / E7 mleczny
C1080038

E7 white ending
zaślepka E7 mleczny
C1840038

MOUNTING / MOCOWANIA

Y flexible mounting plate

colour: inox
material: stainless steel

uchwyt Y sprężysty
kolor: inox
materiał: stal nierdzewna

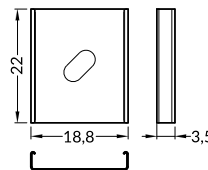
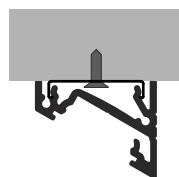

cone Y flexible mounting plate

colour: inox
material: stainless steel

uchwyt Y sprężysty cone
kolor: inox
materiał: stal nierdzewna

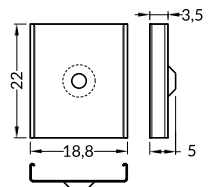
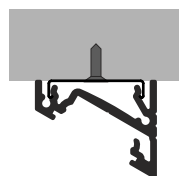

T mounting plate

colour: raw aluminium
material: aluminium

uchwyt T
kolor: surowe aluminium
materiał: aluminium

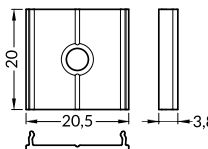
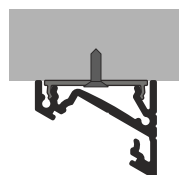

INDEX = 1 set
package of 10 sets = 20 pcs
INDEKS = 1 komplet, opakowanie
zawiera 10 kompletów = 20 szt.

Y flexible mounting plate
uchwyt Y sprężysty



A2090019

cone Y flexible mounting plate
uchwyt Y sprężysty cone



A2130019

T mounting plate
uchwyt T

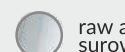

raw aluminium
surowe aluminium
C6960000



ENDINGS / ZAŚLEPKI

CORNER14 ending

colours: white, silver, black, grey
material: ABS

zaślepka CORNER14

kolory: biały, srebrny, czarny, szary
materiał: ABS

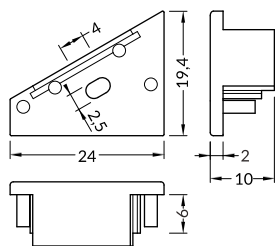

CORNER14 ending with hole

colours: white, silver, black, grey
material: ABS

zaślepka CORNER14 z otworem

kolory: biały, srebrny, czarny, szary
materiał: ABS

INDEX = 1 set
package of 10 sets = 20 pcs
INDEKS = 1 komplet, opakowanie
zawiera 10 kompletów = 20 szt.

white
białe

with hole
z otworem
A4050001

without hole
bez otworu
A4070001

silver
srebrne

with hole
z otworem
A4050040

without hole
bez otworu
A4070040

black
czarne

with hole
z otworem
A4050002

without hole
bez otworu
A4070002

grey
szare

with hole
z otworem
A4050022

without hole
bez otworu
A4070022

CONNECTORS / ŁĄCZNIKI

T connector

colour: raw aluminium
material: aluminium

łącznik T

kolor: surowe aluminium
materiał: aluminium

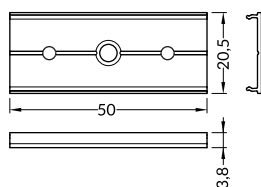

CORNER14 connector 90 deg

colours: white, anodized, black
material: aluminium

łącznik CORNER14 90 st

kolory: biały, anodowany, czarny
materiał: aluminium

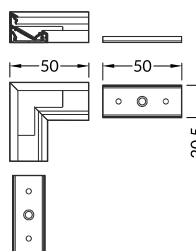

INDEX = 1 set
INDEKS = 1 komplet

T connector / łącznik T

raw aluminium
surowe aluminium
C6990000

connector 90 deg / łącznik 90 st

white painted
biały malowany
A4990001

anodized
anodowany
A4990020

black anodized
czarny anodowany
A4990021

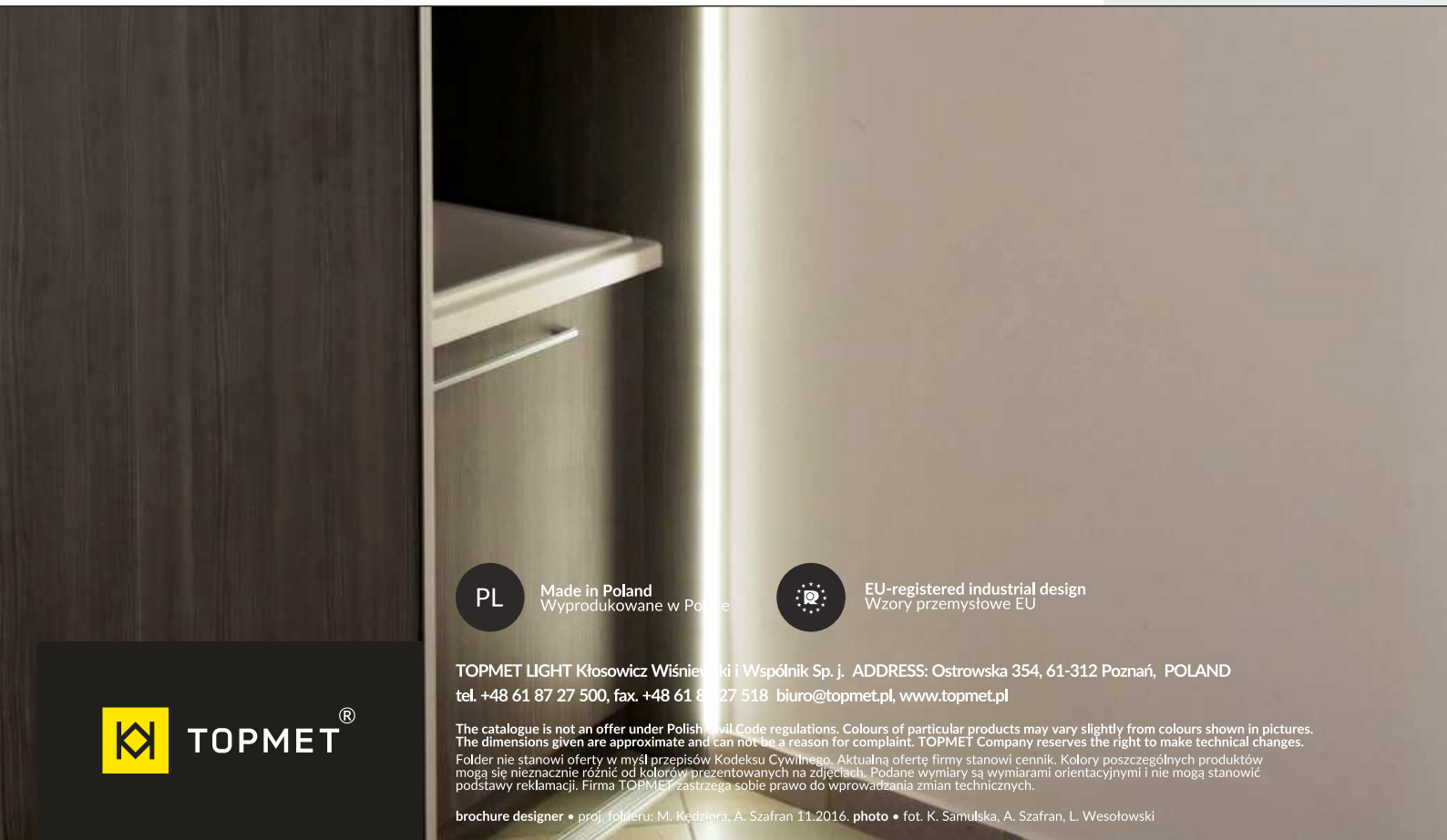

PL

Made in Poland
Wyprodukowane w Polsce



EU-registered industrial design
Wzory przemysłowe EU

TOPMET LIGHT Kłosowicz Wiśniowicki i Wspólnik Sp. j. ADDRESS: Ostrowska 354, 61-312 Poznań, POLAND
tel. +48 61 87 27 500, fax. +48 61 87 27 518 biuro@topmet.pl, www.topmet.pl

The catalogue is not an offer under Polish Civil Code regulations. Colours of particular products may vary slightly from colours shown in pictures. The dimensions given are approximate and can not be a reason for complaint. TOPMET Company reserves the right to make technical changes.

Folder nie stanowi oferty w myśl przepisów Kodeksu Cywilnego. Aktualną ofertę firmy stanowi cennik. Kolory poszczególnych produktów mogą się nieznacznie różnić od kolorów prezentowanych na zdjęciach. Podane wymiary są wymiarami orientacyjnymi i nie mogą stanowić podstawy reklamacji. Firma TOPMET zastrzega sobie prawo do wprowadzania zmian technicznych.

brochure designer • proj. folderu: M. Kedziora, A. Szafran 11.2016. photo • fot. K. Samulska, A. Szafran, L. Wesołowski