

High-Speed CMOS Logic Quad Bilateral Switch

Features

- **Wide Analog-Input-Voltage Range** **0V - 10V**
- **Low "ON" Resistance**
 - $V_{CC} = 4.5V$ **25 Ω**
 - $V_{CC} = 9V$ **15 Ω**
- **Fast Switching and Propagation Delay Times**
- **Low "OFF" Leakage Current**
- **Wide Operating Temperature Range** . . . **-55°C to 125°C**
- **HC Types**
 - **2V to 10V Operation**
 - **High Noise Immunity: $N_{IL} = 30\%$, $N_{IH} = 30\%$ of V_{CC} at $V_{CC} = 5V$ and $10V$**
- **HCT Types**
 - **Direct LSTTL Input Logic Compatibility, $V_{IL} = 0.8V$ (Max), $V_{IH} = 2V$ (Min)**
 - **CMOS Input Compatibility, $I_I \leq 1\mu A$ at V_{OL} , V_{OH}**

Description

The 'HC4066 and CD74HCT4066 contain four independent digitally controlled analog switches that use silicon-gate CMOS technology to achieve operating speeds similar to LSTTL with the low power consumption of standard CMOS integrated circuits.

These switches feature the characteristic linear "ON" resistance of the metal-gate CD4066B. Each switch is turned on by a high-level voltage on its control input.

Ordering Information

PART NUMBER	TEMP. RANGE (°C)	PACKAGE
CD54HC4066F3A	-55 to 125	14 Ld CERDIP
CD74HC4066E	-55 to 125	14 Ld PDIP
CD74HC4066M	-55 to 125	14 Ld SOIC
CD74HC4066MT	-55 to 125	14 Ld SOIC
CD74HC4066M96	-55 to 125	14 Ld SOIC
CD74HC4066PW	-55 to 125	14 Ld TSSOP
CD74HC4066PWR	-55 to 125	14 Ld TSSOP
CD74HC4066PWT	-55 to 125	14 Ld TSSOP
CD74HCT4066E	-55 to 125	14 Ld PDIP
CD74HCT4066M	-55 to 125	14 Ld SOIC
CD74HCT4066MT	-55 to 125	14 Ld SOIC
CD74HCT4066M96	-55 to 125	14 Ld SOIC

NOTE: When ordering, use the entire part number. The suffixes 96 and R denote tape and reel. The suffix T denotes a small-quantity reel of 250.

Pinout

CD54HC4066 (CERDIP)
 CD74HC4066 (PDIP, SOIC, TSSOP)
 CD74HCT4066 (PDIP, SOIC)
 TOP VIEW

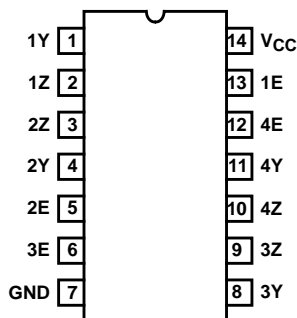

Functional Diagram

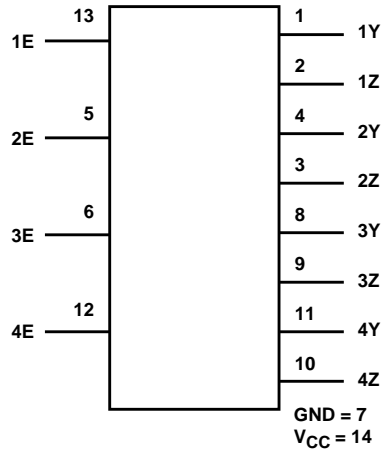

TRUTH TABLE

INPUT nE	SWITCH
L	Off
H	On

H= High Level
 L= Low Level

Logic Diagram

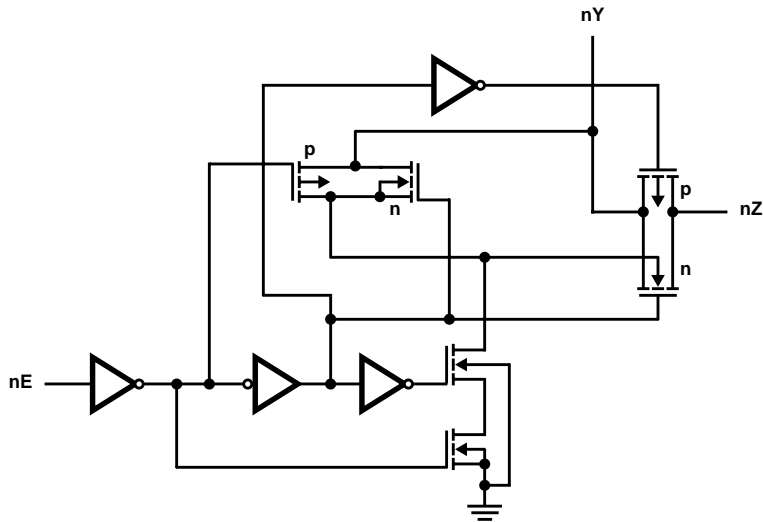

CD54HC4066, CD74HC4066, CD74HCT4066

Absolute Maximum Ratings

DC Supply Voltage, V_{CC}	
HCT Types	-0.5V to 7V
HC Types	-0.5V to 10.5V
DC Input Diode Current, I_{IK}	
For $V_I < -0.5V$ or $V_I > V_{CC} + 0.5V$	$\pm 20mA$
DC Switch Current, I_O (Note 1)	
For $-0.5V < V_O < V_{CC} + 0.5V$	$\pm 25mA$
DC Output Diode Current, I_{OK}	
For $V_O < -0.5V$ or $V_O > V_{CC} + 0.5V$	$\pm 20mA$
DC Output Source or Sink Current per Output Pin, I_O	
For $V_O > -0.5V$ or $V_O < V_{CC} + 0.5V$	$\pm 25mA$
DC V_{CC} or Ground Current, I_{CC}	$\pm 50mA$

Thermal Information

Thermal Resistance (Typical, Note 2)	θ_{JA}
E (PDIP) Package	80°C/W
M (SOIC) Package	86°C/W
PW (TSSOP) Package	113°C/W
Maximum Junction Temperature (Hermetic Package or Die)	175°C
Maximum Junction Temperature (Plastic Package)	150°C
Maximum Storage Temperature Range	-65°C to 150°C
Maximum Lead Temperature (Soldering 10s)	300°C
(SOIC - Lead Tips Only)	

Operating Conditions

Temperature Range, T_A	-55°C to 125°C
Supply Voltage Range, V_{CC}	
HC Types	2V to 10V
HCT Types	4.5V to 5.5V
DC Input or Output Voltage, V_I, V_O	0V to V_{CC}
Input Rise and Fall Time	
2V	1000ns (Max)
4.5V	500ns (Max)
6V	400ns (Max)

CAUTION: Stresses above those listed in "Absolute Maximum Ratings" may cause permanent damage to the device. This is a stress only rating and operation of the device at these or any other conditions above those indicated in the operational sections of this specification is not implied.

NOTES:

- In certain applications, the external load-resistor current may include both V_{CC} and signal-line components. To avoid drawing V_{CC} current when switch current flows into the transmission gate inputs, (terminals 1, 4, 8 and 11) the voltage drop across the bidirectional switch must not exceed 0.6V (calculated from R_{ON} values shown in the DC Electrical Specifications Table). No V_{CC} current will flow through R_L if the switch current flows into terminals 2, 3, 9 and 10.
- The package thermal impedance is calculated in accordance with JESD 51-7.

DC Electrical Specifications

PARAMETER	SYMBOL	TEST CONDITIONS		V_{CC} (V)	25°C			-40°C TO 85°C		-55°C TO 125°C		UNITS
		V_I (V)	V_{IS} (V)		MIN	TYP	MAX	MIN	MAX	MIN	MAX	
HC TYPES												
High Level Input Voltage	V_{IH}	-	-	2	1.5	-	-	1.5	-	1.5	-	V
				4.5	3.15	-	-	3.15	-	3.15	-	V
				9	6.3	-	-	6.3	-	6.3	-	V
Low Level Input Voltage	V_{IL}	-	-	2	-	-	0.5	-	0.5	-	0.5	V
				4.5	-	-	1.35	-	1.35	-	1.35	V
				9	-	-	2.7	-	2.7	-	2.7	V
Input Leakage Current (Any Control)	I_{IL}	V_{CC} or GND	-	10	-	-	± 0.1	-	± 1	-	± 1	μA
Off-Switch Leakage Current	I_Z	V_{IL}	V_{CC} or GND	10	-	-	± 0.1	-	± 1	-	± 1	μA

CD54HC4066, CD74HC4066, CD74HCT4066

DC Electrical Specifications (Continued)

PARAMETER	SYMBOL	TEST CONDITIONS		V _{CC} (V)	25°C			-40°C TO 85°C		-55°C TO 125°C		UNITS
		V _I (V)	V _{IS} (V)		MIN	TYP	MAX	MIN	MAX	MIN	MAX	
"ON" Resistance I _O = 1mA (Figure 1)	R _{ON}	V _{CC}	V _{CC} or GND	4.5	-	25	80	-	106	-	128	Ω
				6	-	20	75	-	94	-	113	Ω
				9	-	15	60	-	78	-	95	Ω
		V _{CC} to GND	4.5	-	35	95	-	118	-	142	Ω	
			6	-	24	84	-	105	-	126	Ω	
			9	-	16	70	-	88	-	105	Ω	
"ON" Resistance Between Any Two Switches	ΔR _{ON}	V _{CC}	-	4.5	-	1	-	-	-	-	-	Ω
				6	-	0.75	-	-	-	-	-	Ω
				9	-	0.5	-	-	-	-	-	Ω
Quiescent Device Current	I _{CC}	V _{CC} or GND	-	6	-	-	2	-	20	-	40	μA
				10	-	-	16	-	160	-	320	μA
HCT TYPES												
High Level Input Voltage	V _{IH}	-	-	4.5 to 5.5	2	-	-	2	-	2	-	V
Low Level Input Voltage	V _{IL}	-	-	4.5 to 5.5	-	-	0.8	-	0.8	-	0.8	V
Input Leakage Current (Any Control)	I _{IL}	V _{CC} or GND	-	5.5	-	-	±0.1	-	±1	-	±1	μA
Off-Switch Leakage Current	I _Z	V _{IL}	V _{CC} or GND	5.5	-	-	±0.1	-	±1	-	±1	μA
"ON" Resistance I _O = 1mA (Figure 1)	R _{ON}	V _{CC}	V _{CC} or GND	4.5	-	25	80	-	106	-	128	Ω
			V _{CC} to GND	4.5	-	35	95	-	118	-	142	Ω
"ON" Resistance Between Any Two Switches	ΔR _{ON}	V _{CC}	-	4.5	-	1	-	-	-	-	-	Ω
Quiescent Device Current	I _{CC}	V _{CC} or GND	-	5.5	-	-	2	-	20	-	40	μA
Additional Quiescent Device Current Per Input Pin: 1 Unit Load	ΔI _{CC} (Note 3)	V _{CC} - 2.1	-	4.5 to 5.5	-	100	360	-	450	-	490	μA

NOTE:

- For dual-supply systems theoretical worst case (V_I = 2.4V, V_{CC} = 5.5V) specification is 1.8mA.

HCT Input Loading Table

INPUT	UNIT LOADS
All	1

NOTE: Unit Load is ΔI_{CC} limit specified in DC Electrical Specifications table, e.g., 360μA max at 25°C.

CD54HC4066, CD74HC4066, CD74HCT4066

Switching Specifications Input $t_r, t_f = 6\text{ns}$

PARAMETER	SYMBOL	TEST CONDITIONS	V_{CC} (V)	25°C			-40°C TO 85°C		-55°C TO 125°C		UNITS
				MIN	TYP	MAX	MIN	MAX	MIN	MAX	
HC TYPES											
Propagation Delay Time Switch In to Out	t_{PLH}, t_{PHL}	$C_L = 50\text{pF}$	2	-	-	60	-	75	-	90	ns
			4.5	-	-	12	-	15	-	18	ns
			9	-	-	8	-	11	-	13	ns
		$C_L = 15\text{pF}$	5	-	4	-	-	-	-	-	ns
Propagation Delay Time Switch Turn On Delay	t_{PZH}, t_{PZL}	$C_L = 50\text{pF}$	2	-	-	100	-	125	-	150	ns
			4.5	-	-	20	-	25	-	30	ns
			9	-	-	12	-	15	-	18	ns
		$C_L = 15\text{pF}$	5	-	8	-	-	-	-	-	ns
Propagation Delay Time Switch Turn Off Delay	t_{PHZ}, t_{PLZ}	$C_L = 50\text{pF}$	2	-	-	150	-	190	-	225	ns
			4.5	-	-	30	-	38	-	45	ns
			9	-	-	24	-	30	-	36	ns
		$C_L = 15\text{pF}$	5	-	12	-	-	-	-	-	ns
Input (Control) Capacitance	C_I	-	-	-	10	-	10	-	10	pF	
Power Dissipation Capacitance (Notes 4, 5)	C_{PD}	-	5	-	25	-	-	-	-	pF	
HCT TYPES											
Propagation Delay Time Switch In to Out	t_{PLH}, t_{PHL}	$C_L = 50\text{pF}$	4.5	-	-	12	-	15	-	18	ns
		$C_L = 15\text{pF}$	5	-	4	-	-	-	-	-	ns
Propagation Delay Time Switch Turn On Delay	t_{PZH}, t_{PZL}	$C_L = 50\text{pF}$	4.5	-	-	24	-	30	-	36	ns
		$C_L = 15\text{pF}$	5	-	9	-	-	-	-	-	ns
Propagation Delay Time Switch Turn Off Delay	t_{PHZ}, t_{PLZ}	$C_L = 50\text{pF}$	4.5	-	-	35	-	44	-	53	ns
		$C_L = 15\text{pF}$	5	-	14	-	-	-	-	-	ns
Input (Control) Capacitance	C_I	-	-	-	10	-	10	-	10	pF	
Power Dissipation Capacitance (Notes 4, 5)	C_{PD}	-	5	-	38	-	-	-	-	pF	

NOTES:

4. C_{PD} is used to determine the dynamic power consumption, per package.
5. $P_D = C_{PD} V_{CC}^2 f_i + \sum (C_L + C_S) V_{CC}^2 f_o$ where f_i = input frequency, f_o = output frequency, C_L = output load capacitance, C_S = switch capacitance, V_{CC} = supply voltage.

Analog Channel Specifications $T_A = 25^\circ\text{C}$

PARAMETER	TEST CONDITIONS	V_{CC} (V)	HC4066	CD74HCT4066	UNITS
Switch Frequency Response Bandwidth at -3dB Figure 2	Figure 5, Notes 6, 7	4.5	200	200	MHz
Cross Talk Between Any Two Switches Figure 3	Figure 4, Notes 7, 8	4.5	-72	-72	dB
Total Harmonic Distortion	Figure 6, 1kHz, $V_{IS} = 4V_{P-P}$	4.5	0.022	0.023	%
	Figure 6, 1kHz, $V_{IS} = 8V_{P-P}$	9	0.008	N/A	%

CD54HC4066, CD74HC4066, CD74HCT4066

Analog Channel Specifications $T_A = 25^\circ\text{C}$ (Continued)

PARAMETER	TEST CONDITIONS	V_{CC} (V)	HC4066	CD74HCT4066	UNITS
Control to Switch Feedthrough Noise	Figure 7	4.5	200	130	mV
		9	550	N/A	mV
Switch "OFF" Signal Feedthrough Figure 3	Figure 8, Notes 7, 8	4.5	-72	-72	dB
Switch Input Capacitance, C_S		-	5	5	pF

NOTES:

6. Adjust input level for 0dBm at output, $f = 1\text{MHz}$.
7. V_{IS} is centered at $V_{CC}/2$.
8. Adjust input for 0dBm at V_{IS} .

Typical Performance Curves



FIGURE 1. TYPICAL "ON" RESISTANCE vs INPUT SIGNAL VOLTAGE

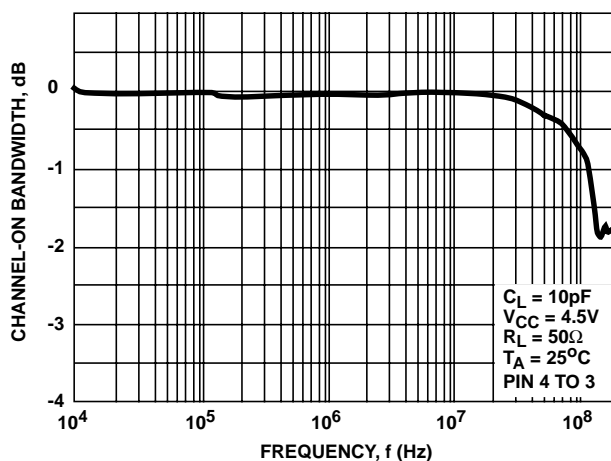

FIGURE 2. SWITCH FREQUENCY RESPONSE, $V_{CC} = 4.5\text{V}$

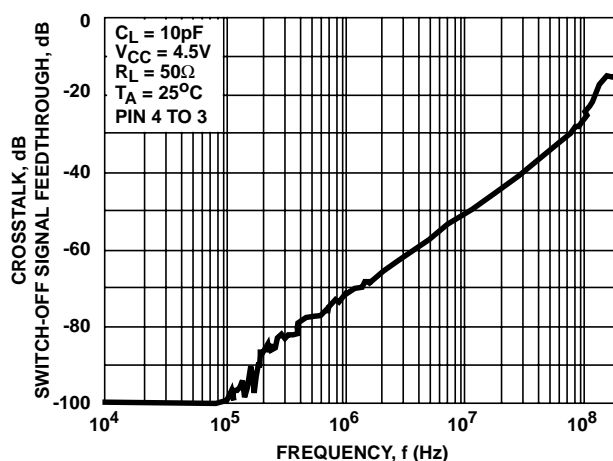

FIGURE 3. SWITCH-OFF SIGNAL FEEDTHROUGH AND CROSSTALK vs FREQUENCY, $V_{CC} = 4.5\text{V}$

Analog Test Circuits

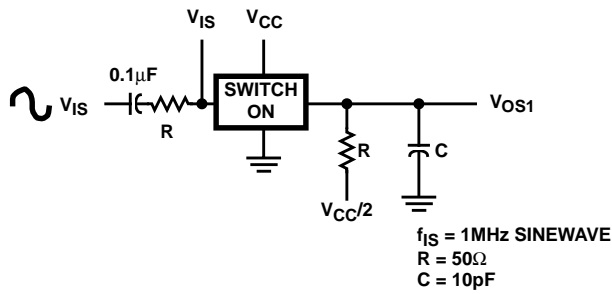

FIGURE 4. CROSTALK BETWEEN TWO SWITCHES TEST CIRCUIT

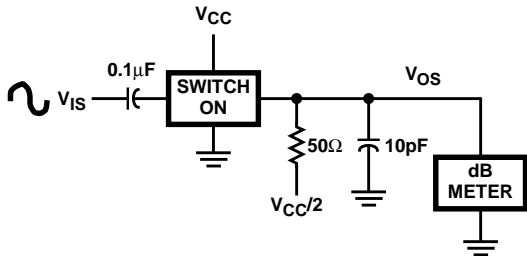

FIGURE 6. TOTAL HARMONIC DISTORTION TEST CIRCUIT

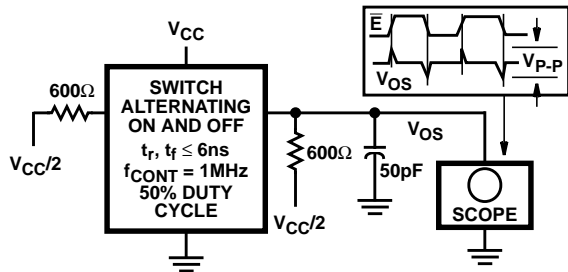

FIGURE 7. CONTROL-TO-SWITCH FEEDTHROUGH NOISE TEST CIRCUIT

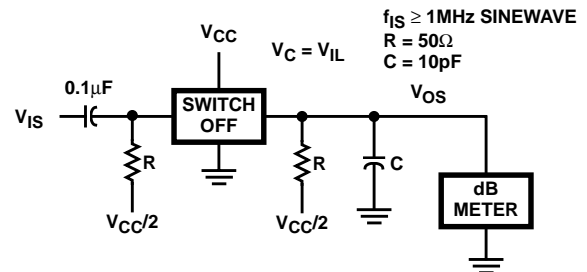

FIGURE 8. SWITCH OFF SIGNAL FEEDTHROUGH

Test Circuits and Waveforms

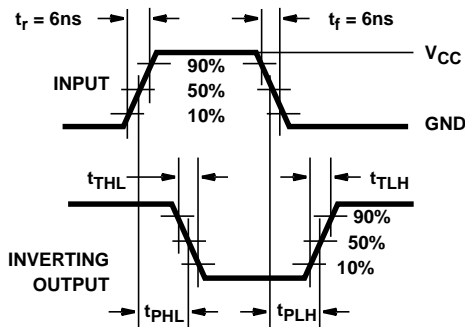

FIGURE 9. HC TRANSITION TIMES AND PROPAGATION DELAY TIMES, COMBINATION LOGIC

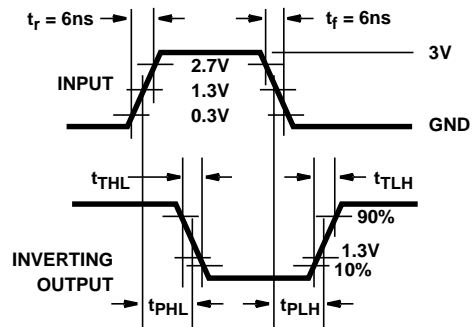

FIGURE 10. HCT TRANSITION TIMES AND PROPAGATION DELAY TIMES, COMBINATION LOGIC

PACKAGING INFORMATION

Orderable Device	Status (1)	Package Type	Package Drawing	Pins	Package Qty	Eco Plan (2)	Lead/Ball Finish (6)	MSL Peak Temp (3)	Op Temp (°C)	Device Marking (4/5)	Samples
5962-8950701CA	ACTIVE	CDIP	J	14	1	TBD	A42	N / A for Pkg Type	-55 to 125	5962-8950701CA CD54HC4066F3A	Samples
CD54HC4066F3A	ACTIVE	CDIP	J	14	1	TBD	A42	N / A for Pkg Type	-55 to 125	5962-8950701CA CD54HC4066F3A	Samples
CD74HC4066E	ACTIVE	PDIP	N	14	25	Pb-Free (RoHS)	CU NIPDAU	N / A for Pkg Type	-55 to 125	CD74HC4066E	Samples
CD74HC4066EE4	ACTIVE	PDIP	N	14	25	Pb-Free (RoHS)	CU NIPDAU	N / A for Pkg Type	-55 to 125	CD74HC4066E	Samples
CD74HC4066M	ACTIVE	SOIC	D	14	50	Green (RoHS & no Sb/Br)	CU NIPDAU	Level-1-260C-UNLIM	-55 to 125	HC4066M	Samples
CD74HC4066M96	ACTIVE	SOIC	D	14	2500	Green (RoHS & no Sb/Br)	CU NIPDAU	Level-1-260C-UNLIM	-55 to 125	HC4066M	Samples
CD74HC4066M96E4	ACTIVE	SOIC	D	14	2500	Green (RoHS & no Sb/Br)	CU NIPDAU	Level-1-260C-UNLIM	-55 to 125	HC4066M	Samples
CD74HC4066M96G4	ACTIVE	SOIC	D	14	2500	Green (RoHS & no Sb/Br)	CU NIPDAU	Level-1-260C-UNLIM	-55 to 125	HC4066M	Samples
CD74HC4066ME4	ACTIVE	SOIC	D	14	50	Green (RoHS & no Sb/Br)	CU NIPDAU	Level-1-260C-UNLIM	-55 to 125	HC4066M	Samples
CD74HC4066MG4	ACTIVE	SOIC	D	14	50	Green (RoHS & no Sb/Br)	CU NIPDAU	Level-1-260C-UNLIM	-55 to 125	HC4066M	Samples
CD74HC4066MT	ACTIVE	SOIC	D	14	250	Green (RoHS & no Sb/Br)	CU NIPDAU	Level-1-260C-UNLIM	-55 to 125	HC4066M	Samples
CD74HC4066PW	ACTIVE	TSSOP	PW	14	90	Green (RoHS & no Sb/Br)	CU NIPDAU	Level-1-260C-UNLIM	-55 to 125	HP4066	Samples
CD74HC4066PWG4	ACTIVE	TSSOP	PW	14	90	Green (RoHS & no Sb/Br)	CU NIPDAU	Level-1-260C-UNLIM	-55 to 125	HP4066	Samples
CD74HC4066PWR	ACTIVE	TSSOP	PW	14	2000	Green (RoHS & no Sb/Br)	CU NIPDAU	Level-1-260C-UNLIM	-55 to 125	HP4066	Samples
CD74HC4066PWRG4	ACTIVE	TSSOP	PW	14	2000	Green (RoHS & no Sb/Br)	CU NIPDAU	Level-1-260C-UNLIM	-55 to 125	HP4066	Samples
CD74HC4066PWT	ACTIVE	TSSOP	PW	14	250	Green (RoHS & no Sb/Br)	CU NIPDAU	Level-1-260C-UNLIM	-55 to 125	HP4066	Samples
CD74HCT4066E	ACTIVE	PDIP	N	14	25	Pb-Free (RoHS)	CU NIPDAU	N / A for Pkg Type	-55 to 125	CD74HCT4066E	Samples

Orderable Device	Status (1)	Package Type	Package Drawing	Pins	Package Qty	Eco Plan (2)	Lead/Ball Finish (6)	MSL Peak Temp (3)	Op Temp (°C)	Device Marking (4/5)	Samples
CD74HCT4066M	ACTIVE	SOIC	D	14	50	Green (RoHS & no Sb/Br)	CU NIPDAU	Level-1-260C-UNLIM	-55 to 125	HCT4066M	Samples
CD74HCT4066M96	ACTIVE	SOIC	D	14	2500	Green (RoHS & no Sb/Br)	CU NIPDAU	Level-1-260C-UNLIM	-55 to 125	HCT4066M	Samples
CD74HCT4066M96G4	ACTIVE	SOIC	D	14	2500	Green (RoHS & no Sb/Br)	CU NIPDAU	Level-1-260C-UNLIM	-55 to 125	HCT4066M	Samples
CD74HCT4066ME4	ACTIVE	SOIC	D	14	50	Green (RoHS & no Sb/Br)	CU NIPDAU	Level-1-260C-UNLIM	-55 to 125	HCT4066M	Samples
CD74HCT4066MT	ACTIVE	SOIC	D	14	250	Green (RoHS & no Sb/Br)	CU NIPDAU	Level-1-260C-UNLIM	-55 to 125	HCT4066M	Samples
CD74HCT4066MTG4	ACTIVE	SOIC	D	14	250	Green (RoHS & no Sb/Br)	CU NIPDAU	Level-1-260C-UNLIM	-55 to 125	HCT4066M	Samples

(1) The marketing status values are defined as follows:

ACTIVE: Product device recommended for new designs.

LIFEBUY: TI has announced that the device will be discontinued, and a lifetime-buy period is in effect.

NRND: Not recommended for new designs. Device is in production to support existing customers, but TI does not recommend using this part in a new design.

PREVIEW: Device has been announced but is not in production. Samples may or may not be available.

OBSELETE: TI has discontinued the production of the device.

(2) Eco Plan - The planned eco-friendly classification: Pb-Free (RoHS), Pb-Free (RoHS Exempt), or Green (RoHS & no Sb/Br) - please check <http://www.ti.com/productcontent> for the latest availability information and additional product content details.

TBD: The Pb-Free/Green conversion plan has not been defined.

Pb-Free (RoHS): TI's terms "Lead-Free" or "Pb-Free" mean semiconductor products that are compatible with the current RoHS requirements for all 6 substances, including the requirement that lead not exceed 0.1% by weight in homogeneous materials. Where designed to be soldered at high temperatures, TI Pb-Free products are suitable for use in specified lead-free processes.

Pb-Free (RoHS Exempt): This component has a RoHS exemption for either 1) lead-based flip-chip solder bumps used between the die and package, or 2) lead-based die adhesive used between the die and leadframe. The component is otherwise considered Pb-Free (RoHS compatible) as defined above.

Green (RoHS & no Sb/Br): TI defines "Green" to mean Pb-Free (RoHS compatible), and free of Bromine (Br) and Antimony (Sb) based flame retardants (Br or Sb do not exceed 0.1% by weight in homogeneous material)

(3) MSL, Peak Temp. - The Moisture Sensitivity Level rating according to the JEDEC industry standard classifications, and peak solder temperature.

(4) There may be additional marking, which relates to the logo, the lot trace code information, or the environmental category on the device.

(5) Multiple Device Markings will be inside parentheses. Only one Device Marking contained in parentheses and separated by a "-" will appear on a device. If a line is indented then it is a continuation of the previous line and the two combined represent the entire Device Marking for that device.

⁽⁶⁾ Lead/Ball Finish - Orderable Devices may have multiple material finish options. Finish options are separated by a vertical ruled line. Lead/Ball Finish values may wrap to two lines if the finish value exceeds the maximum column width.

Important Information and Disclaimer:The information provided on this page represents TI's knowledge and belief as of the date that it is provided. TI bases its knowledge and belief on information provided by third parties, and makes no representation or warranty as to the accuracy of such information. Efforts are underway to better integrate information from third parties. TI has taken and continues to take reasonable steps to provide representative and accurate information but may not have conducted destructive testing or chemical analysis on incoming materials and chemicals. TI and TI suppliers consider certain information to be proprietary, and thus CAS numbers and other limited information may not be available for release.

In no event shall TI's liability arising out of such information exceed the total purchase price of the TI part(s) at issue in this document sold by TI to Customer on an annual basis.

OTHER QUALIFIED VERSIONS OF CD54HC4066, CD74HC4066, CD74HCT4066 :

- Catalog: [CD74HC4066](#)

- Automotive: [CD74HCT4066-Q1](#)

- Military: [CD54HC4066](#)

NOTE: Qualified Version Definitions:

- Catalog - TI's standard catalog product

- Automotive - Q100 devices qualified for high-reliability automotive applications targeting zero defects

- Military - QML certified for Military and Defense Applications

TAPE AND REEL INFORMATION

QUADRANT ASSIGNMENTS FOR PIN 1 ORIENTATION IN TAPE

*All dimensions are nominal

Device	Package Type	Package Drawing	Pins	SPQ	Reel Diameter (mm)	Reel Width W1 (mm)	A0 (mm)	B0 (mm)	K0 (mm)	P1 (mm)	W (mm)	Pin1 Quadrant
CD74HC4066M96	SOIC	D	14	2500	330.0	16.4	6.5	9.0	2.1	8.0	16.0	Q1
CD74HC4066MT	SOIC	D	14	250	330.0	16.4	6.5	9.0	2.1	8.0	16.0	Q1
CD74HC4066PWR	TSSOP	PW	14	2000	330.0	12.4	6.9	5.6	1.6	8.0	12.0	Q1
CD74HC4066PWT	TSSOP	PW	14	250	330.0	12.4	6.9	5.6	1.6	8.0	12.0	Q1
CD74HCT4066M96	SOIC	D	14	2500	330.0	16.4	6.5	9.0	2.1	8.0	16.0	Q1
CD74HCT4066MT	SOIC	D	14	250	330.0	16.4	6.5	9.0	2.1	8.0	16.0	Q1

TAPE AND REEL BOX DIMENSIONS

*All dimensions are nominal

Device	Package Type	Package Drawing	Pins	SPQ	Length (mm)	Width (mm)	Height (mm)
CD74HC4066M96	SOIC	D	14	2500	367.0	367.0	38.0
CD74HC4066MT	SOIC	D	14	250	367.0	367.0	38.0
CD74HC4066PWR	TSSOP	PW	14	2000	367.0	367.0	35.0
CD74HC4066PWT	TSSOP	PW	14	250	367.0	367.0	35.0
CD74HCT4066M96	SOIC	D	14	2500	367.0	367.0	38.0
CD74HCT4066MT	SOIC	D	14	250	367.0	367.0	38.0

J (R-GDIP-T**)

14 LEADS SHOWN

CERAMIC DUAL IN-LINE PACKAGE



DIM \ PINS **	14	16	18	20
A	0.300 (7,62) BSC	0.300 (7,62) BSC	0.300 (7,62) BSC	0.300 (7,62) BSC
B MAX	0.785 (19,94)	.840 (21,34)	0.960 (24,38)	1.060 (26,92)
B MIN	—	—	—	—
C MAX	0.300 (7,62)	0.300 (7,62)	0.310 (7,87)	0.300 (7,62)
C MIN	0.245 (6,22)	0.245 (6,22)	0.220 (5,59)	0.245 (6,22)



4040083/F 03/03

- NOTES:
- All linear dimensions are in inches (millimeters).
 - This drawing is subject to change without notice.
 - This package is hermetically sealed with a ceramic lid using glass frit.
 - Index point is provided on cap for terminal identification only on press ceramic glass frit seal only.
 - Falls within MIL STD 1835 GDIP1-T14, GDIP1-T16, GDIP1-T18 and GDIP1-T20.

N (R-PDIP-T**)

PLASTIC DUAL-IN-LINE PACKAGE

16 PINS SHOWN



- NOTES:
- A. All linear dimensions are in inches (millimeters).
 - B. This drawing is subject to change without notice.
 - $\triangle C$ Falls within JEDEC MS-001, except 18 and 20 pin minimum body length (Dim A).
 - $\triangle D$ The 20 pin end lead shoulder width is a vendor option, either half or full width.

4040049/E 12/2002

D (R-PDSO-G14)

PLASTIC SMALL OUTLINE



- NOTES:
- A. All linear dimensions are in inches (millimeters).
 - B. This drawing is subject to change without notice.
 - $\triangle C$ Body length does not include mold flash, protrusions, or gate burrs. Mold flash, protrusions, or gate burrs shall not exceed 0.006 (0,15) each side.
 - $\triangle D$ Body width does not include interlead flash. Interlead flash shall not exceed 0.017 (0,43) each side.
 - E. Reference JEDEC MS-012 variation AB.

D (R-PDSO-G14)

PLASTIC SMALL OUTLINE



- NOTES:
- A. All linear dimensions are in millimeters.
 - B. This drawing is subject to change without notice.
 - C. Publication IPC-7351 is recommended for alternate designs.
 - D. Laser cutting apertures with trapezoidal walls and also rounding corners will offer better paste release. Customers should contact their board assembly site for stencil design recommendations. Refer to IPC-7525 for other stencil recommendations.
 - E. Customers should contact their board fabrication site for solder mask tolerances between and around signal pads.

PW (R-PDSO-G14)

PLASTIC SMALL OUTLINE



- NOTES:
- All linear dimensions are in millimeters.
 - This drawing is subject to change without notice.
 - Publication IPC-7351 is recommended for alternate designs.
 - Laser cutting apertures with trapezoidal walls and also rounding corners will offer better paste release. Customers should contact their board assembly site for stencil design recommendations. Refer to IPC-7525 for other stencil recommendations.
 - Customers should contact their board fabrication site for solder mask tolerances between and around signal pads.

IMPORTANT NOTICE

Texas Instruments Incorporated and its subsidiaries (TI) reserve the right to make corrections, enhancements, improvements and other changes to its semiconductor products and services per JESD46, latest issue, and to discontinue any product or service per JESD48, latest issue. Buyers should obtain the latest relevant information before placing orders and should verify that such information is current and complete. All semiconductor products (also referred to herein as "components") are sold subject to TI's terms and conditions of sale supplied at the time of order acknowledgment.

TI warrants performance of its components to the specifications applicable at the time of sale, in accordance with the warranty in TI's terms and conditions of sale of semiconductor products. Testing and other quality control techniques are used to the extent TI deems necessary to support this warranty. Except where mandated by applicable law, testing of all parameters of each component is not necessarily performed.

TI assumes no liability for applications assistance or the design of Buyers' products. Buyers are responsible for their products and applications using TI components. To minimize the risks associated with Buyers' products and applications, Buyers should provide adequate design and operating safeguards.

TI does not warrant or represent that any license, either express or implied, is granted under any patent right, copyright, mask work right, or other intellectual property right relating to any combination, machine, or process in which TI components or services are used. Information published by TI regarding third-party products or services does not constitute a license to use such products or services or a warranty or endorsement thereof. Use of such information may require a license from a third party under the patents or other intellectual property of the third party, or a license from TI under the patents or other intellectual property of TI.

Reproduction of significant portions of TI information in TI data books or data sheets is permissible only if reproduction is without alteration and is accompanied by all associated warranties, conditions, limitations, and notices. TI is not responsible or liable for such altered documentation. Information of third parties may be subject to additional restrictions.

Resale of TI components or services with statements different from or beyond the parameters stated by TI for that component or service voids all express and any implied warranties for the associated TI component or service and is an unfair and deceptive business practice. TI is not responsible or liable for any such statements.

Buyer acknowledges and agrees that it is solely responsible for compliance with all legal, regulatory and safety-related requirements concerning its products, and any use of TI components in its applications, notwithstanding any applications-related information or support that may be provided by TI. Buyer represents and agrees that it has all the necessary expertise to create and implement safeguards which anticipate dangerous consequences of failures, monitor failures and their consequences, lessen the likelihood of failures that might cause harm and take appropriate remedial actions. Buyer will fully indemnify TI and its representatives against any damages arising out of the use of any TI components in safety-critical applications.

In some cases, TI components may be promoted specifically to facilitate safety-related applications. With such components, TI's goal is to help enable customers to design and create their own end-product solutions that meet applicable functional safety standards and requirements. Nonetheless, such components are subject to these terms.

No TI components are authorized for use in FDA Class III (or similar life-critical medical equipment) unless authorized officers of the parties have executed a special agreement specifically governing such use.

Only those TI components which TI has specifically designated as military grade or "enhanced plastic" are designed and intended for use in military/aerospace applications or environments. Buyer acknowledges and agrees that any military or aerospace use of TI components which have **not** been so designated is solely at the Buyer's risk, and that Buyer is solely responsible for compliance with all legal and regulatory requirements in connection with such use.

TI has specifically designated certain components as meeting ISO/TS16949 requirements, mainly for automotive use. In any case of use of non-designated products, TI will not be responsible for any failure to meet ISO/TS16949.

Products

Audio	www.ti.com/audio
Amplifiers	amplifier.ti.com
Data Converters	dataconverter.ti.com
DLP® Products	www.dlp.com
DSP	dsp.ti.com
Clocks and Timers	www.ti.com/clocks
Interface	interface.ti.com
Logic	logic.ti.com
Power Mgmt	power.ti.com
Microcontrollers	microcontroller.ti.com
RFID	www.ti-rfid.com
OMAP Applications Processors	www.ti.com/omap
Wireless Connectivity	www.ti.com/wirelessconnectivity

Applications

Automotive and Transportation	www.ti.com/automotive
Communications and Telecom	www.ti.com/communications
Computers and Peripherals	www.ti.com/computers
Consumer Electronics	www.ti.com/consumer-apps
Energy and Lighting	www.ti.com/energy
Industrial	www.ti.com/industrial
Medical	www.ti.com/medical
Security	www.ti.com/security
Space, Avionics and Defense	www.ti.com/space-avionics-defense
Video and Imaging	www.ti.com/video

TI E2E Community

e2e.ti.com