

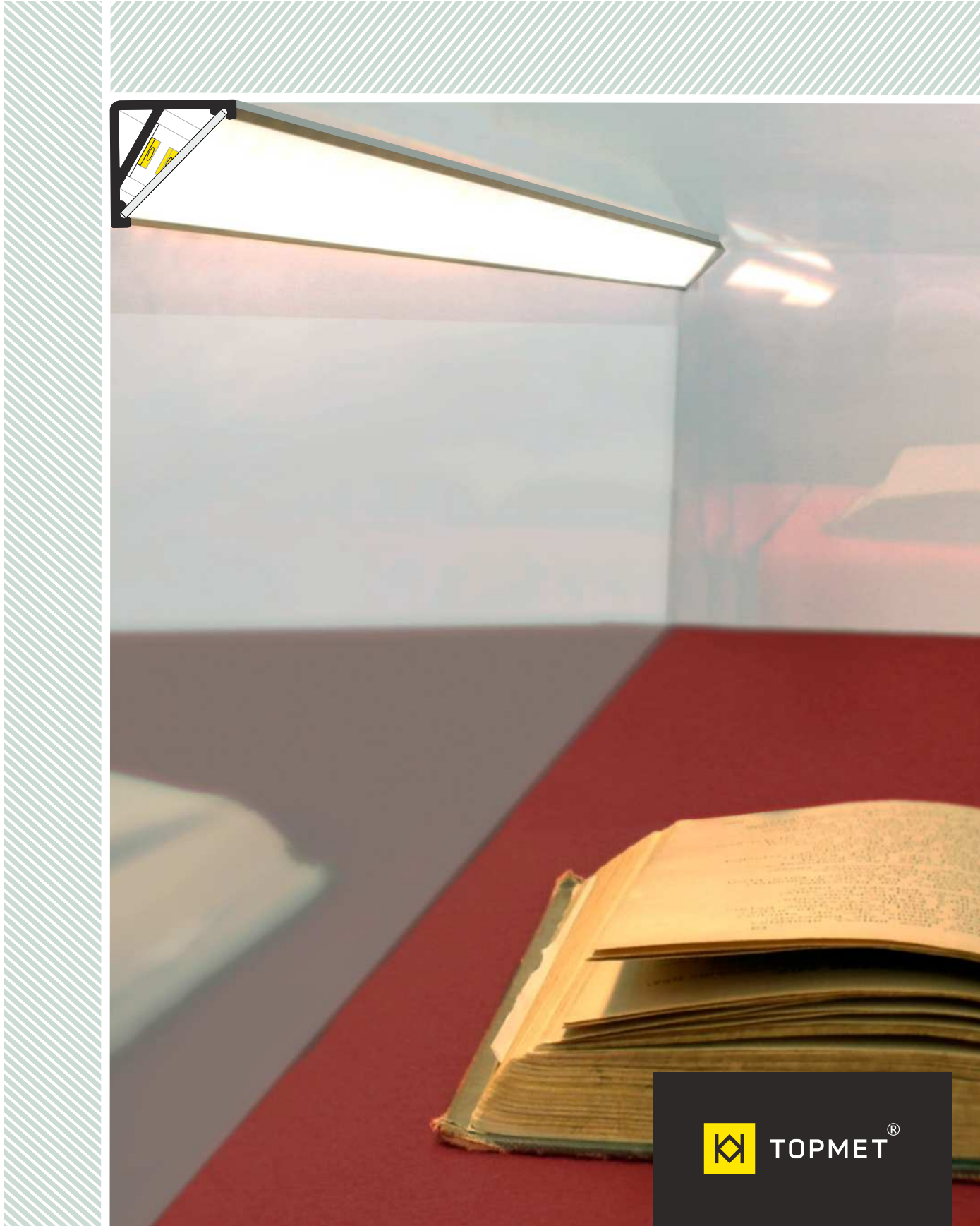

# CABI12 E

ALUMINIUM LED PROFILE FOR SHOWCASE  
PROFIL ALUMINIOWY DO OŚWIETLENIA WNĘTRZA GABLOTY



# CABI12 E

- discreet angular aluminium profile for a showcase usage.
  - illuminate your showcase vertically and horizontally, in two angles available 30 and 60 degrees
  - SLICK socket
  - maximum LED strip width: 12mm
- dyskretny, aluminiowy profil kątowny do zastosowania w gablocie
  - oświetli gablotę w pionie i poziomie w dwóch kątach 30 i 60 stopni do wyboru
  - gniazdo SLICK
  - maksymalna szerokość taśmy LED: 12 mm

**E** slide cover  
klosz E wsuwany

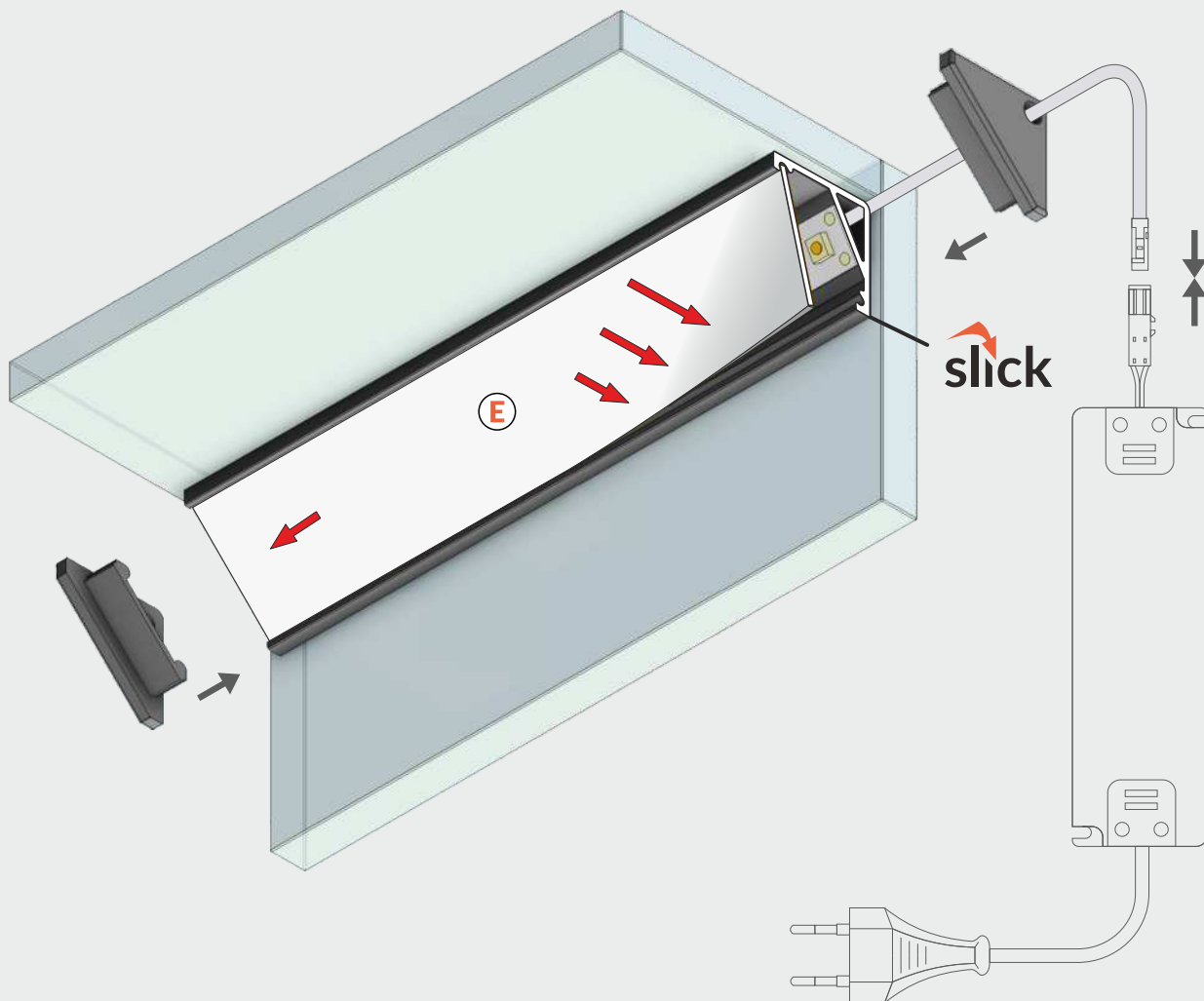

mounting / montaż:

ways of lighting / sposoby oświetlania:

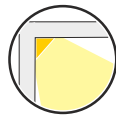
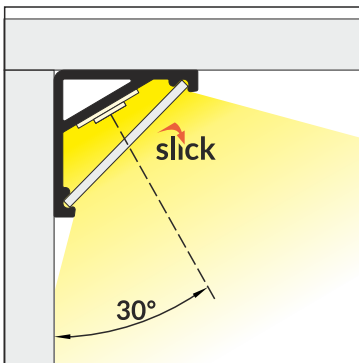

30° down  
30° w dół

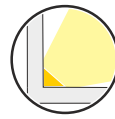

30° up  
30° w górę

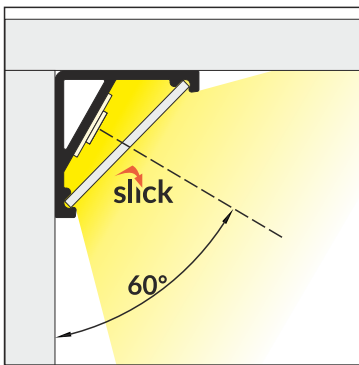

60° down  
60° w dół

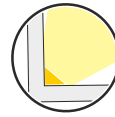

60° up  
60° w górę

examples of profile connection methods / przykładowe sposoby łączenia profili:

## CABI12 E

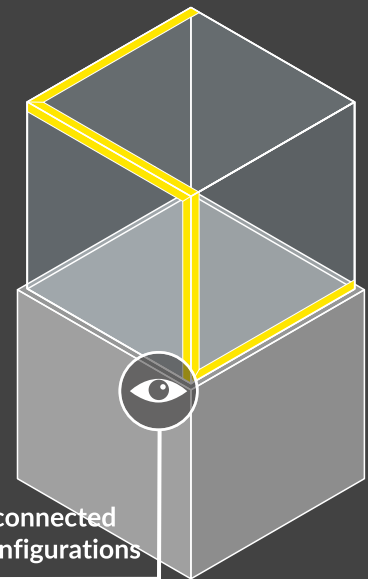
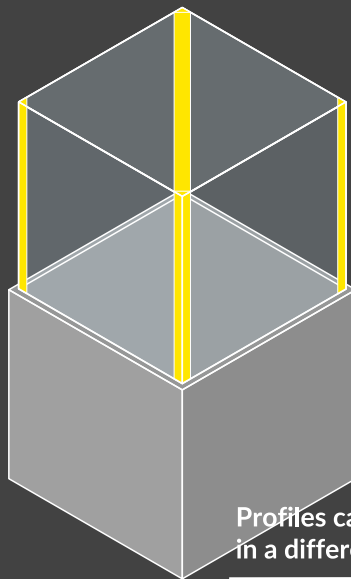
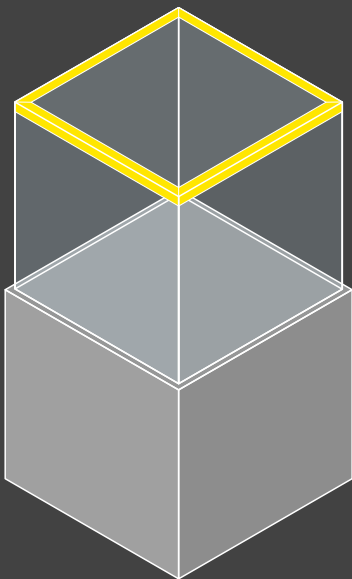

Profiles can be connected  
in a different configurations

Profile można łączyć ze sobą  
w różnych konfiguracjach

# CABI12 E

## SMALL SIZE AND NO HOLDERS

Thanks to its small size and no holders, this profile doesn't interfere with a showcase appearance.

## MAŁY ROZMIAR I BRAK UCHWYTÓW

Dzięki swoim niewielkim gabarytom i brakiem uchwytów, profil minimalnie ingeruje w wygląd gabloty

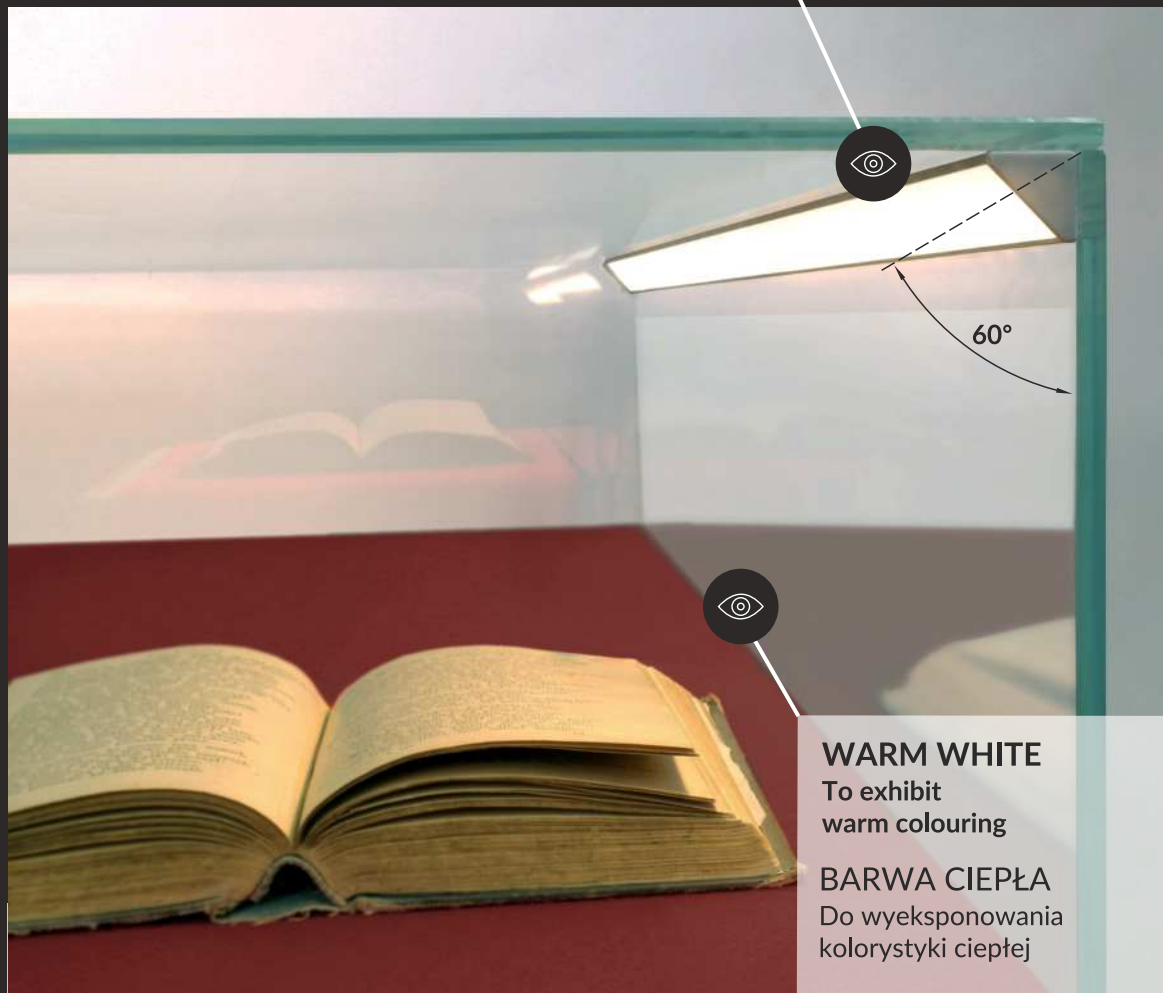

### WARM WHITE

To exhibit warm colouring

### BARWA CIEPŁA

Do wyeksponowania kolorystyki ciepłej

## EQUAL SIDE LENGTHS

The symmetrical profile design allows precise connections in a different configurations

## RÓWNE DŁUGOŚCI BOKÓW

Symetryczna budowa profilu pozwala na precyzyjne łączenie w różnych konfiguracjach



## TWO LIGHTING ANGLES

The ability to choose lighting angle allows to create no glare light source, well illuminating interior of a showcase and exposition at the same time.

## DWA KĄTY ŚWIECENIA

Możliwość wyboru kąta świecenia pozwala stworzyć nierażące światło, równocześnie dobrze oświetlając wnętrze gabloty oraz ekspozycję



## COOL WHITE

To exhibit cool colouring

## BARWA ZIMNA

Do wyeksponowania kolorystyki zimnej

## DESIGNED FOR SHOWCASES ENTIRELY MADE OF GLASS

In order to paste in the glass showcases the electro polished chrome-like coating has been used

## SPECJALNIE DLA GABLOT WYKONANYCH ZE SZKŁA

Z myślą o wklejeniu w gabloty wykonane w całości ze szkła, zastosowana została elektropolerowana powłoka przypominająca chrom

## INVISIBLE WIRES

This profile has a special channel to hide the wires, which influences the aesthetics of a showcase

## NIEWIDOCZNE PRZEWODY

Profil posiada kanał do schowania przewodów, co wpływa dodatnio na estetykę gabloty

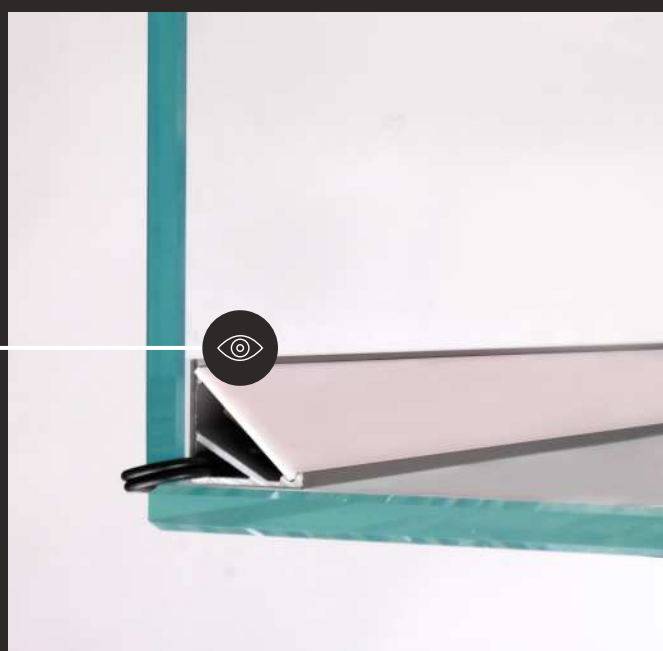

# CABI12 E

Available in stock  
Dostępny na magazynie



 slick

available colours:  
dostępne kolory:



 slick  
mounting  
montaż

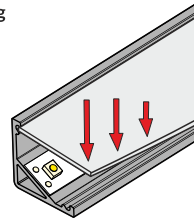

 slick  
removal  
demontaż

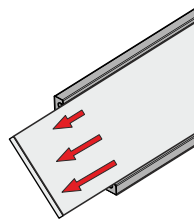

Profile with SLICK socket  
(slide + click)  
- easy assembly and  
disassembly of a cover

Profil z gniazdem SLICK  
(slide + click)  
- łatwy montaż i  
demontaż klosza

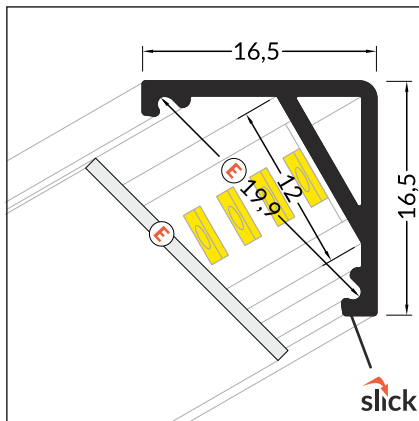

max 12 mm



surface  
nawierzchniowy



EU patented industrial designs  
Wzory przemysłowe EU

INDEX for packaging of 10 pcs  
for 2000 mm length  
INDEKS dla opakowania zbiorczego po 10 sztuk  
dla długości 2000 mm



 white painted  
biały malowany  
C9020001



 anodized  
anodowany  
C9020020



 black anodized  
czarny anodowany  
C9020021



 raw aluminium  
surowe aluminium  
C9020000



## COVERS / KLOSZE

**E slide cover**  
colours: transparent, frosted, white  
material: PC, PP, PET

klosz E wsuwany  
kolory: transparentny, szron, mleczny  
materiał: PC, PP, PET

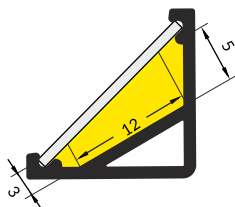
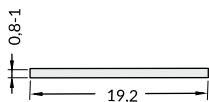

Dimensions of the space  
needed to install LED source.  
Wymiary przestrzeni do zamontowania  
źródła LED.

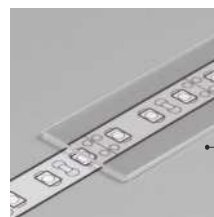

INDEX for packaging of 10 pcs  
for 2000 mm length  
INDEKS dla opakowania zbiorczego  
po 10 sztuk  
dla długości 2000 mm

transparent E / E transparentny  
A2040016

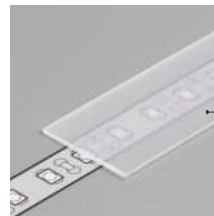

frosted E / E szron  
A2040039

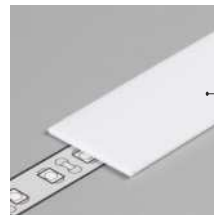

white E / E mleczny  
A2040038

## ENDINGS / ZAŚLEPKI



endings CABI12  
colours: grey, black, white, silver  
material: ABS

zaślepka CABI12  
kolory: szary, czarny, biały, srebrny  
materiał: ABS

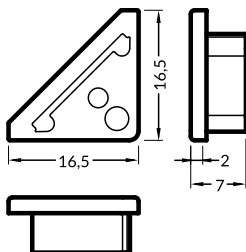

Note! Ending thickness increases  
the length of the luminaires.  
Uwaga! Grubość zaślepki  
zwiększa długość oprawy.

The ability to drill endings  
to conduct the wire, if necessary.  
Możliwość przewiercenia zaślepek  
w razie potrzeby przeprowadzenia przewodu.



INDEX for packaging of  
10 sets = 20 pcs  
INDEKS dla opakowania zbiorczego  
po 10 kompletów = 20 szt.

white  
białe C9980001



silver  
srebrne C9980040



black  
czarne C9980002



grey  
szare C9980022

## SURFACE / NAWIERZCHNIOWE



SLIM8  
A/Z



SMART10  
A/Z



SURFACE10  
BC/UX



UNI12  
BCD/U



SURFACE14  
EF/TY



LINEA20  
EF/TY



WIDE24  
G/W

## RECESSED / WPUSTOWE



FLAT8  
H/UX



DEEP10  
BC/UX



GROOVE10  
BC/UX



FLOOR12  
K/U



GROOVE14  
EF/TY

## CORNER / KĄTOWE



TRIO10  
BC



CORNER10  
BC/UX



CABI12  
E



CORNER14  
EF/TY



CORNER27  
G/UX

## GLASS / DO SZKŁA



TWIN8



EDGE10  
BC



MIKRO10



MIKRO-LINE12

## SPECIAL APPLICATION / SPECJALNE



PEN8  
I



BACK10  
A/UX



STEP10  
C



WALLE12  
CD



MIKRO-LINE LINIA12  
J



AMBI12  
C



OUTSTAIRS12  
BC



FIX12



ARC12  
CD/R



FRAME14  
BC/Q



FIX16



OVAL20  
BC

PL

Made in Poland  
Wyprodukowane w Polsce



EU patented industrial designs  
Wzory przemysłowe EU

TOPMET LIGHT Kłósowicz Wiśniewski i Wspólnik Sp. j. ADDRESS: Ostrowska 354, 61-312 Poznań, POLAND  
tel. +48 61 87 27 500, fax. +48 61 87 27 518 biuro@topmet.pl, www.topmet.pl

The catalogue is not an offer under Polish Civil Code regulations. Colours of particular products may vary slightly from colours shown in pictures. The dimensions given are approximate and can not be a reason for complaint. TOPMET Company reserves the right to make technical changes.  
Folder nie stanowi oferty w myśl przepisów Kodeksu Cywilnego. Aktualną ofertę firmy stanowi cennik. Kolory poszczególnych produktów mogą się nieznacznie różnić od kolorów prezentowanych na zdjęciach. Podane wymiary są wymiarami orientacyjnymi i nie mogą stanowić podstawy reklamacji. Firma TOPMET zastrzega sobie prawo do wprowadzania zmian technicznych.

brochure designer • proj. folderu: M. Kędziora, S. Wojsz 02.2016. photo • fot. K. Samulska, A. Szafran, L. Wesółowski