

G2-LAURA-RS-P

~8° spot beam. Assembly with thinner white holder, installation tape and location pins.

TECHNICAL SPECIFICATIONS:

Dimensions	21.6 mm
Height	13.1 mm
Fastening	tape, pin
Colour	white
Box size	
Box weight	5.9 kg
Quantity in Box	pcs
ROHS compliant	yes ⓘ

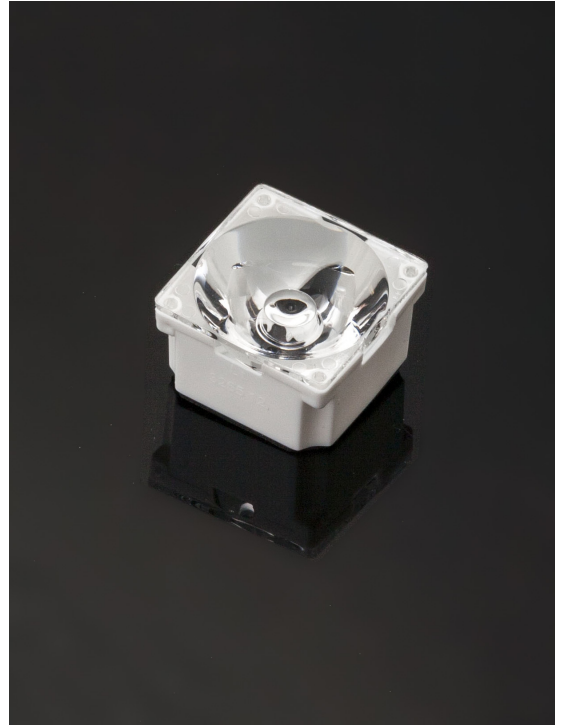

MATERIAL SPECIFICATIONS:

Component	Type	Material	Colour
LAURA-RS	Single lens	PMMA	clear
LAURA-LT-PIN-XP-HLD-WHT	Holder	PC	white
ROSE-TAPE	Tape	PU tape	black

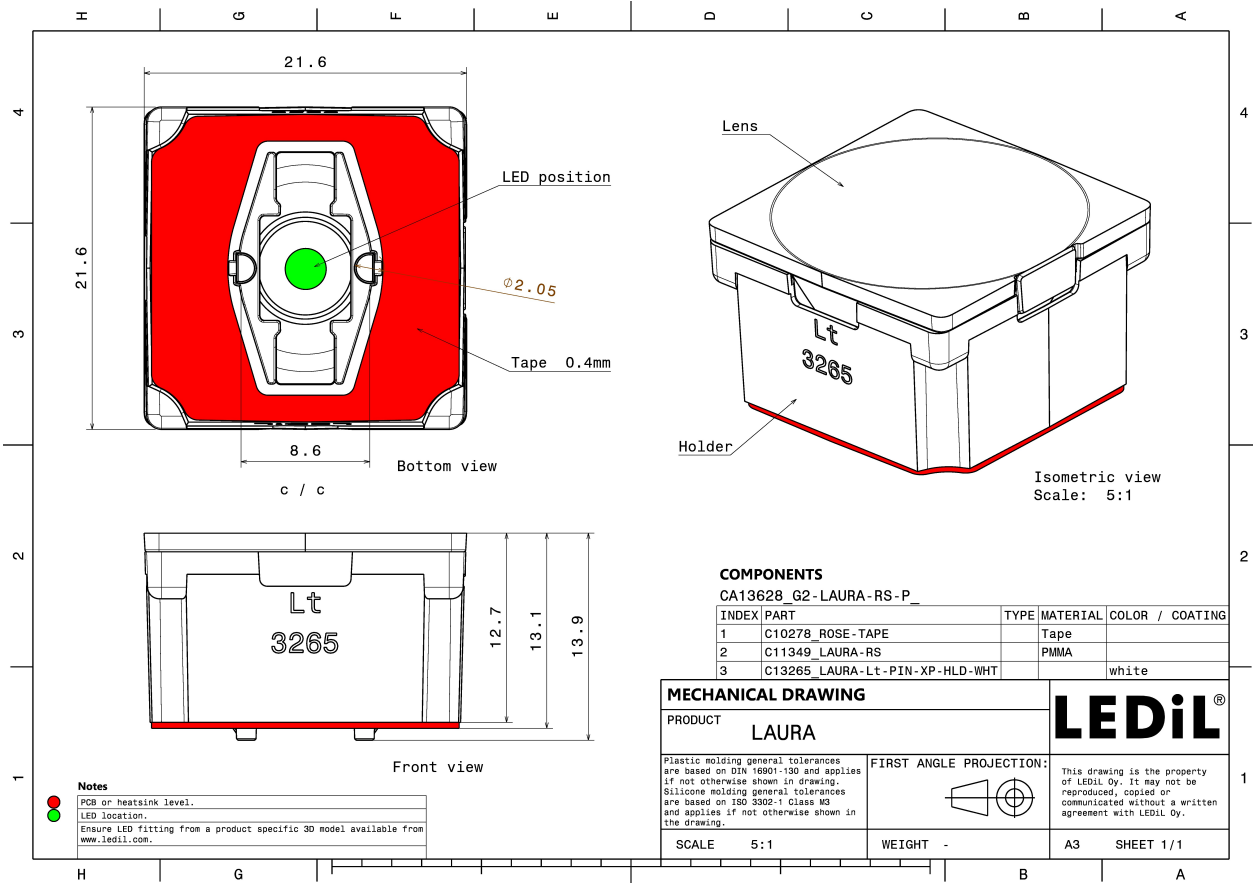

PHOTOMETRIC DATA (MEASURED):

CREE

LED XB-H
 FWHM 11.0°
 Efficiency 91 %
 Peak intensity 20.500 cd/lm
 LEDs/each optic 1
 Light colour White
 Required components:

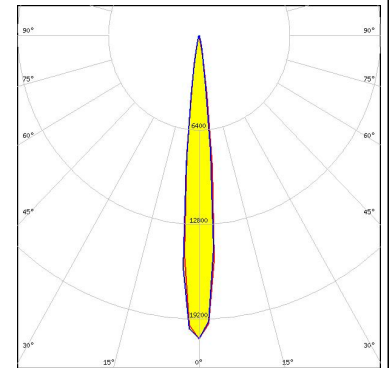
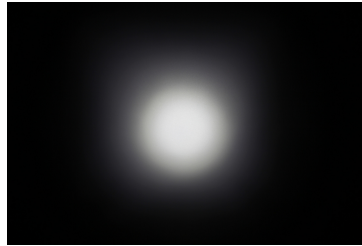

CREE

LED XP-E
 FWHM 8.0°
 Efficiency 93 %
 Peak intensity 33.200 cd/lm
 LEDs/each optic 1
 Light colour White
 Required components:

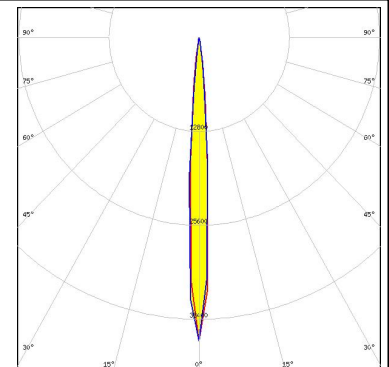

CREE

LED XP-E2
 FWHM 8.0°
 Efficiency 91 %
 Peak intensity 41.400 cd/lm
 LEDs/each optic 1
 Light colour White
 Required components:

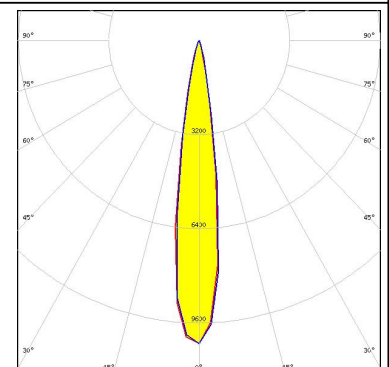
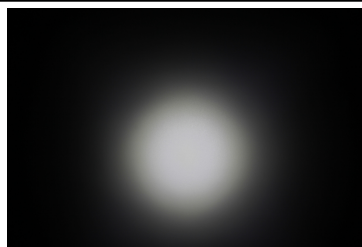

CREE

LED XP-L HD
 FWHM 16.0°
 Efficiency 90 %
 Peak intensity 10.320 cd/lm
 LEDs/each optic 1
 Light colour White
 Required components:

PHOTOMETRIC DATA (MEASURED):



LED XQ-E HI
 FWHM 5.0°
 Efficiency 94 %
 Peak intensity 65.300 cd/lm
 LEDs/each optic 1
 Light colour White
 Required components:

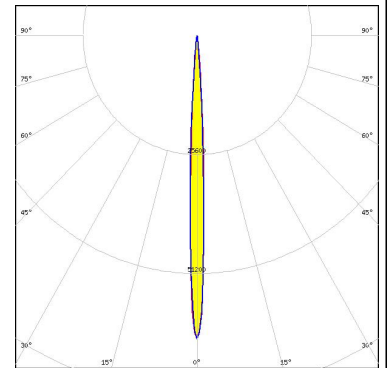
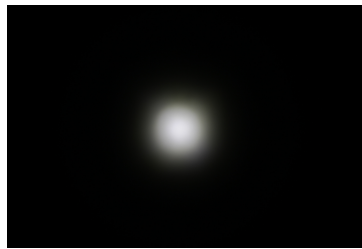

LED LUXEON 3030 2D (Round LES)
 FWHM 9.0°
 Efficiency 92 %
 Peak intensity 22.700 cd/lm
 LEDs/each optic 1
 Light colour White
 Required components:

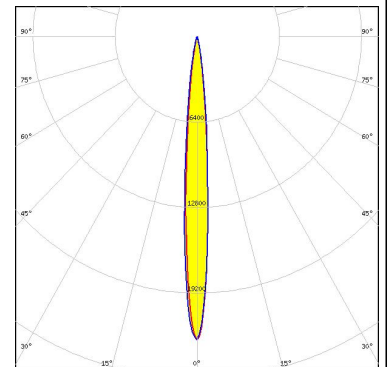
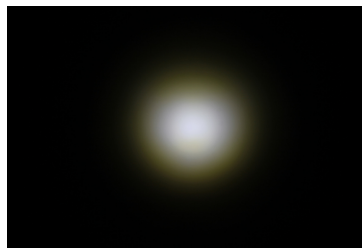

LED LUXEON TX
 FWHM 11.0°
 Efficiency 90 %
 Peak intensity 20.000 cd/lm
 LEDs/each optic 1
 Light colour White
 Required components:

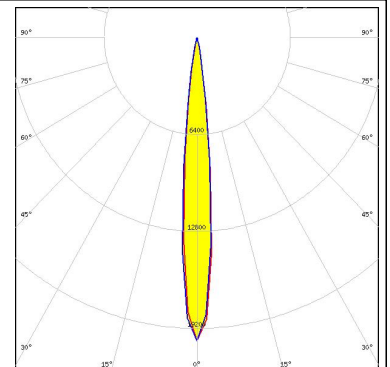
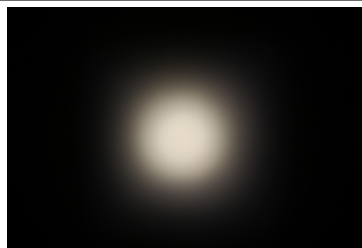

LED NCSxx19A
 FWHM 10.0°
 Efficiency 90 %
 Peak intensity 25.300 cd/lm
 LEDs/each optic 1
 Light colour White
 Required components:

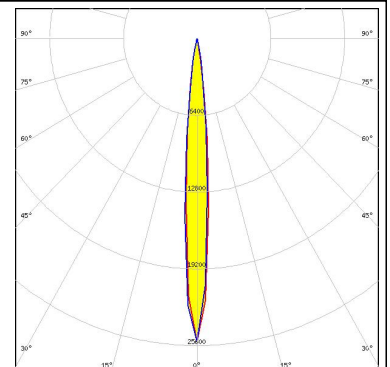

PHOTOMETRIC DATA (MEASURED):



LED NVSW219D
 FWHM 12.0°
 Efficiency 94 %
 Peak intensity 15.900 cd/lm
 LEDs/each optic 1
 Light colour White
 Required components:

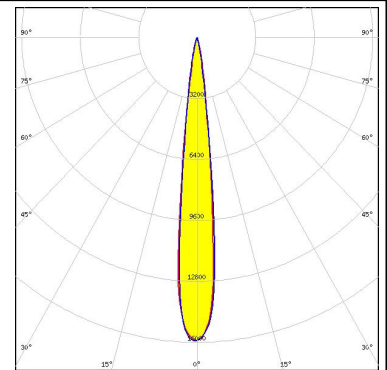

LED NVSxx19A
 FWHM 12.0°
 Efficiency 90 %
 Peak intensity 17.800 cd/lm
 LEDs/each optic 1
 Light colour White
 Required components:

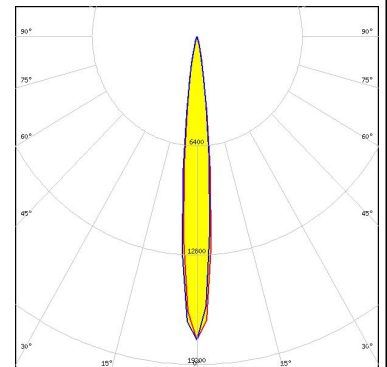

LED NVSxx19B/NVSxx19C
 FWHM 12.0°
 Efficiency 90 %
 Peak intensity 16.300 cd/lm
 LEDs/each optic 1
 Light colour White
 Required components:



SEOUL SEMICONDUCTOR

LED Z5M1/Z5M2
 FWHM 11.0°
 Efficiency 91 %
 Peak intensity 20.000 cd/lm
 LEDs/each optic 1
 Light colour White
 Required components:

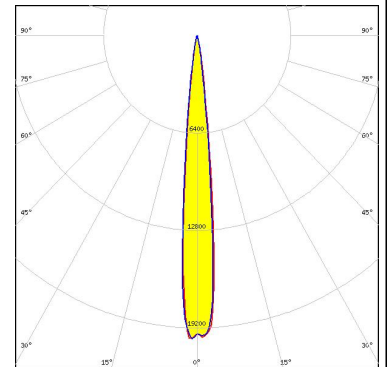

PHOTOMETRIC DATA (SIMULATED):



LED XHP35 HD
 FWHM 14.0°
 Efficiency 94 %
 Peak intensity 7.560 cd/lm
 LEDs/each optic 1
 Light colour White
 Required components:

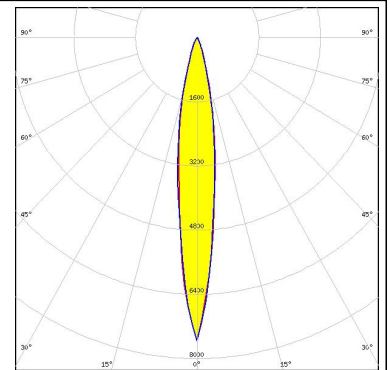

LED XHP35 HI
 FWHM 12.0°
 Efficiency 94 %
 Peak intensity 16.100 cd/lm
 LEDs/each optic 1
 Light colour White
 Required components:

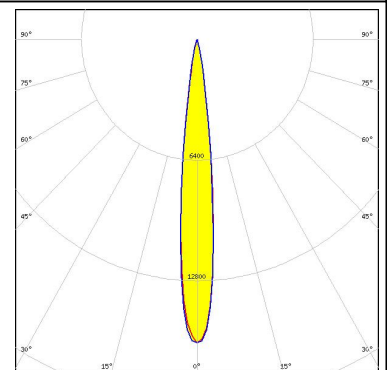

LED XQ-E HD
 FWHM 6.9°
 Efficiency 94 %
 Peak intensity 44.900 cd/lm
 LEDs/each optic 1
 Light colour White
 Required components:

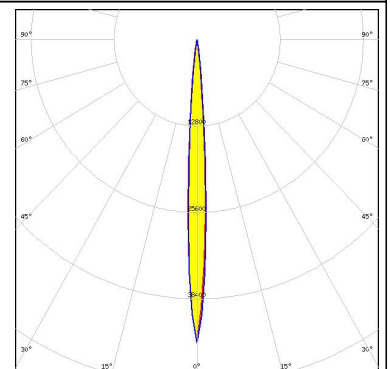
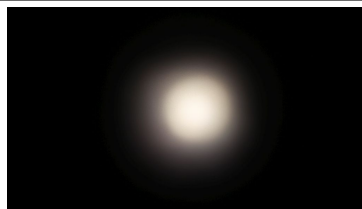

LED NVSxE21A
 FWHM 10.0°
 Efficiency 94 %
 Peak intensity 21.140 cd/lm
 LEDs/each optic 1
 Light colour White
 Required components:

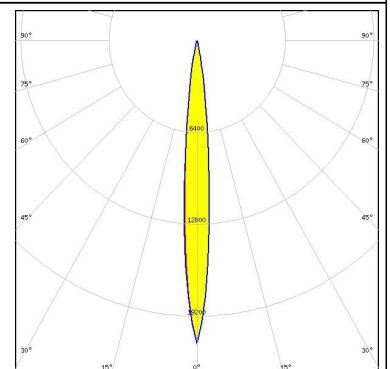

PHOTOMETRIC DATA (SIMULATED):

OSRAM

Osram Opto Semiconductors

LED Oslon Black
 FWHM 9.5°
 Efficiency 97 %
 Peak intensity 23.000 cd/lm
 LEDs/each optic 1
 Light colour White
 Required components:

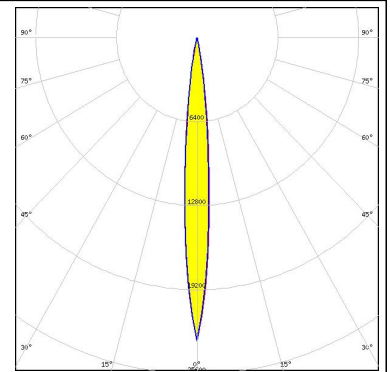

OSRAM

Osram Opto Semiconductors

LED Oslon Black Flat
 FWHM 6.8°
 Efficiency 94 %
 Peak intensity 48.300 cd/lm
 LEDs/each optic 1
 Light colour White
 Required components:

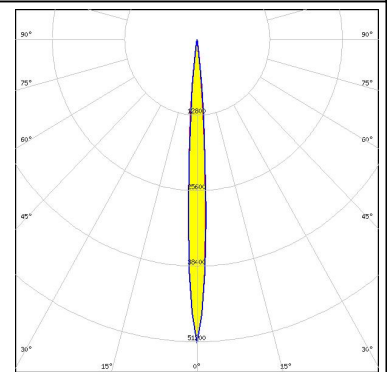

OSRAM

Osram Opto Semiconductors

LED SFH 4770S
 FWHM 10.0°
 Efficiency 94 %
 Peak intensity cd/lm
 LEDs/each optic 1
 Light colour White
 Required components:

SAMSUNG

LED LH351Z
 FWHM 10.0°
 Efficiency 93 %
 Peak intensity 25.000 cd/lm
 LEDs/each optic 1
 Light colour White
 Required components:

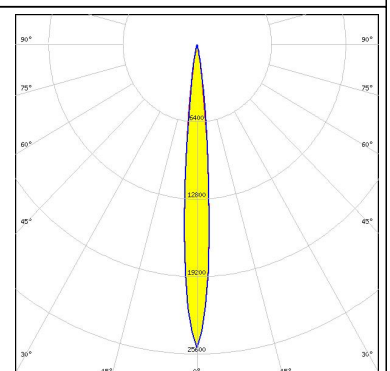

GENERAL INFORMATION:

NOTE: The typical beam angle will be changed by different color, chip size and chip position tolerance. The typical total beam angle is the full angle measured where the luminous intensity is half of the peak value.

MATERIALS:

As part of our continuous research and improvement processes, and to ensure the best possible quality and availability of our products, LEDiL reserves the right to change material grades without notice.

PRODUCT DATA USER AGREEMENT AND DISCLAIMER:

The measured data in the provided downloadable LEDiL Product Datasheets and Mechanical 2D-Drawings is rounded and provided as reference for planning. LEDiL Oy's optical specifications have been verified by conducting performance testing of the products in accordance with the company's quality system. The reported data are averaged results of multiple measurements with typical variation. LEDiL Oy reserves the right to without prior notification make changes and improvements to its products.

LEDiL Oy assumes neither warranty, nor guarantee nor any other liability of any kind for the contents and correctness of the provided data. The provided data has been generated with highest diligence but the provided data may in reality not represent the complete possible variation range of all intrinsic parameters. Therefore, in certain cases a deviation from the provided data could occur.

LEDiL Oy reserves the right to undertake technical changes of its products without further notification which could lead to changes in the provided data. LEDiL Oy assumes no liability of any kind for the possible deviation from any provided data or any other damage resulting from the usage of the provided data.

The user agrees to this disclaimer and user agreement with the download or usage of the provided files.

LEDiL Oy

Joensuunkatu 13
FI-24240 SALO
Finland

LEDiL Inc.

228 West Page Street
Suite D
Sycamore IL 60178
USA

Local sales and technical support

[www.ledil.com/
where_to_buy](http://www.ledil.com/where_to_buy)

Shipping locations

Salo, Finland
Hong Kong, China

Distribution Partners

[www.ledil.com/
where_to_buy](http://www.ledil.com/where_to_buy)