



C2M0160120D

Silicon Carbide Power MOSFET C2M™ MOSFET Technology

N-Channel Enhancement Mode

Features

- New C2M SiC MOSFET technology
- High Blocking Voltage with Low On-Resistance
- High Speed Switching with Low Capacitances
- Easy to Parallel and Simple to Drive
- Avalanche Ruggedness
- Resistant to Latch-Up
- Halogen Free, RoHS Compliant

Benefits

- Higher System Efficiency
- Reduced Cooling Requirements
- Increased Power Density
- Increased System Switching Frequency

Applications

- Solar Inverters
- Switch Mode Power Supplies
- High Voltage DC/DC Converters
- LED Lighting Power Supplies

V_{DS}	1200 V
$I_D @ 25^\circ C$	19 A
$R_{DS(on)}$	160 mΩ

Package

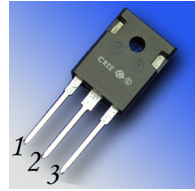

TO-247-3

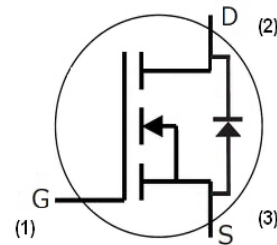

Part Number	Package
C2M0160120D	TO-247-3

Maximum Ratings ($T_C = 25^\circ C$ unless otherwise specified)

Symbol	Parameter	Value	Unit	Test Conditions	Note
V_{DSmax}	Drain - Source Voltage	1200	V	$V_{GS} = 0 V, I_D = 100 \mu A$	
V_{GSmax}	Gate - Source Voltage	-10/+25	V	Absolute maximum values	
V_{GSop}	Gate - Source Voltage	-5/+20	V	Recommended operational values	
I_D	Continuous Drain Current	19	A	$V_{GS} = 20 V, T_C = 25^\circ C$	Fig. 19
		12.5		$V_{GS} = 20 V, T_C = 100^\circ C$	
$I_{D(pulse)}$	Pulsed Drain Current	40	A	Pulse width t_p limited by T_{jmax}	Fig. 22
P_D	Power Dissipation	125	W	$T_C = 25^\circ C, T_J = 150^\circ C$	Fig. 20
T_J, T_{stg}	Operating Junction and Storage Temperature	-55 to +150	$^\circ C$		
T_L	Solder Temperature	260	$^\circ C$	1.6mm (0.063") from case for 10s	
M_d	Mounting Torque	1	Nm lbf-in	M3 or 6-32 screw	
		8.8			



Electrical Characteristics (T_C = 25°C unless otherwise specified)

Symbol	Parameter	Min.	Typ.	Max.	Unit	Test Conditions	Note
V _{(BR)DSS}	Drain-Source Breakdown Voltage	1200			V	V _{GS} = 0 V, I _D = 100 μA	
V _{GS(th)}	Gate Threshold Voltage	2.4	2.5		V	V _{DS} = 10V, I _{DS} = 2.5 mA	Fig. 11
		1.8	1.9		V	V _{DS} = 10V, I _{DS} = 2.5 mA, T _J = 150°C	
I _{DSS}	Zero Gate Voltage Drain Current		1	100	μA	V _{DS} = 1200 V, V _{GS} = 0 V	
I _{GSS}	Gate-Source Leakage Current			250	nA	V _{GS} = 20 V, V _{DS} = 0 V	
R _{DS(on)}	Drain-Source On-State Resistance		160	196	mΩ	V _{GS} = 20 V, I _D = 10 A	Fig. 4, 5, 6
			290			V _{GS} = 20 V, I _D = 10A, T _J = 150°C	
g _{fs}	Transconductance		4.8		S	V _{DS} = 20 V, I _{DS} = 10 A	Fig. 7
			4.3			V _{DS} = 20 V, I _{DS} = 10 A, T _J = 150°C	
C _{iss}	Input Capacitance		525		pF	V _{GS} = 0 V V _{DS} = 1000 V f = 1 MHz	Fig. 17, 18
C _{oss}	Output Capacitance		47				
C _{rss}	Reverse Transfer Capacitance		4				
E _{oss}	C _{oss} Stored Energy		25		μJ	V _{AC} = 25 mV	Fig. 16
E _{AS}	Avalanche Energy, Single Pluse		600		mJ	I _D = 10A, V _{DD} = 50V	Fig. 29
E _{ON}	Turn-On Switching Energy		79		μJ	V _{DS} = 800 V, V _{GS} = -5/20 V, I _D = 10A, R _{G(ext)} = 2.5Ω, L = 256 μH	Fig. 25
E _{OFF}	Turn Off Switching Energy		57				
t _{d(on)}	Turn-On Delay Time		9		ns	V _{DD} = 800 V, V _{GS} = -5/20 V I _D = 10 A R _{G(ext)} = 2.5 Ω, R _L = 80 Ω Timing relative to V _{DS} Per IEC60747-8-4 pg 83	Fig. 27
t _r	Rise Time		11				
t _{d(off)}	Turn-Off Delay Time		16				
t _f	Fall Time		10				
R _{G(int)}	Internal Gate Resistance		6.5		Ω	f = 1 MHz, V _{AC} = 25 mV	
Q _{gs}	Gate to Source Charge		7		nC	V _{DS} = 800 V, V _{GS} = -5/20 V I _D = 10 A Per IEC60747-8-4 pg 21	Fig. 12
Q _{gd}	Gate to Drain Charge		14				
Q _g	Total Gate Charge		34				

Reverse Diode Characteristics

Symbol	Parameter	Typ.	Max.	Unit	Test Conditions	Note
V _{SD}	Diode Forward Voltage	3.3		V	V _{GS} = -5 V, I _F = 5 A	Fig. 8,9, 10
		3.1			V _{GS} = -5V, I _F = 5 A, T _J = 150 °C	
I _S	Continuous Diode Forward Current		19	A	T _C = 25°C	Note 1
t _{rr}	Reverse Recovery Time	23		ns	V _{GS} = -5 V, I _{SD} = 10 A, V _R = 800 V dif/dt = 3200 A/μs	Note 1
Q _{rr}	Reverse Recovery Charge	105		nC		
I _{rrm}	Peak Reverse Recovery Current	9		A		

Note (1): When using SiC Body Diode the maximum recommended V_{GS} = -5V

Thermal Characteristics

Symbol	Parameter	Typ.	Max.	Unit	Test Conditions	Note
R _{θJC}	Thermal Resistance from Junction to Case	0.9	1.0	K/W		Fig. 21
R _{θJA}	Thermal Resistance From Junction to Ambient		40			

Typical Performance

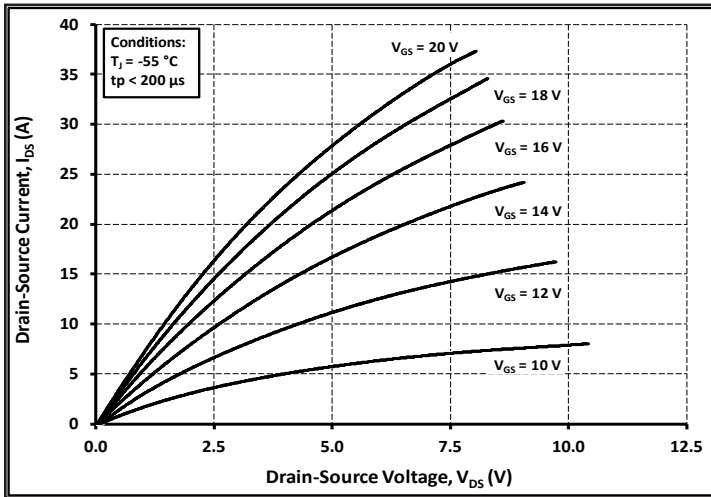

Figure 1. Output Characteristics $T_j = -55\text{ }^\circ\text{C}$

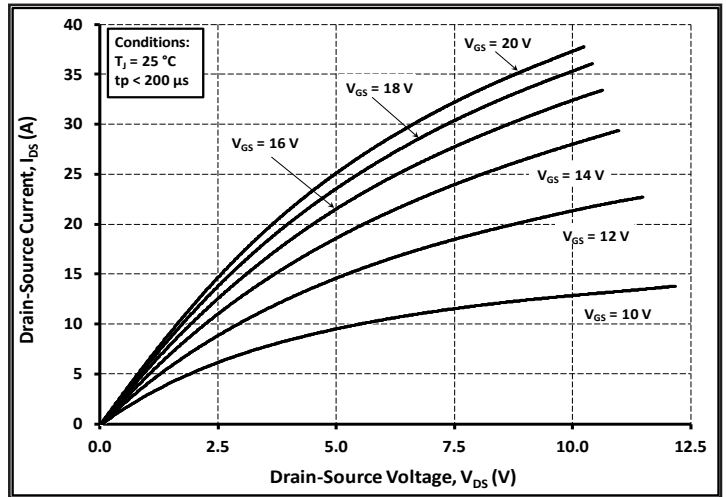

Figure 2. Output Characteristics $T_j = 25\text{ }^\circ\text{C}$

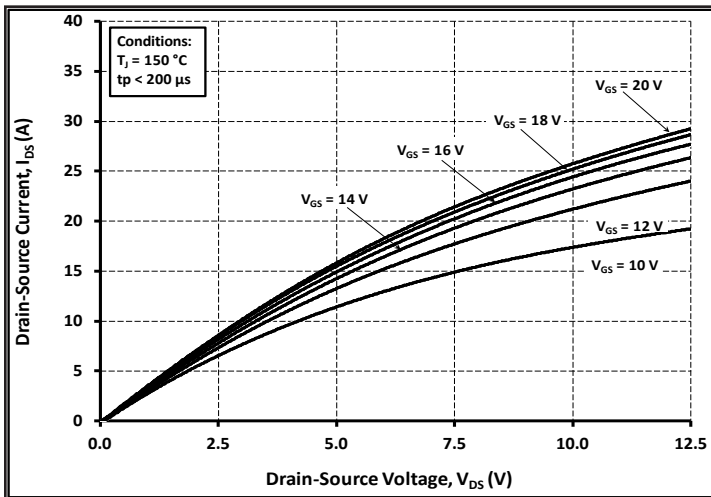

Figure 3. Output Characteristics $T_j = 150\text{ }^\circ\text{C}$

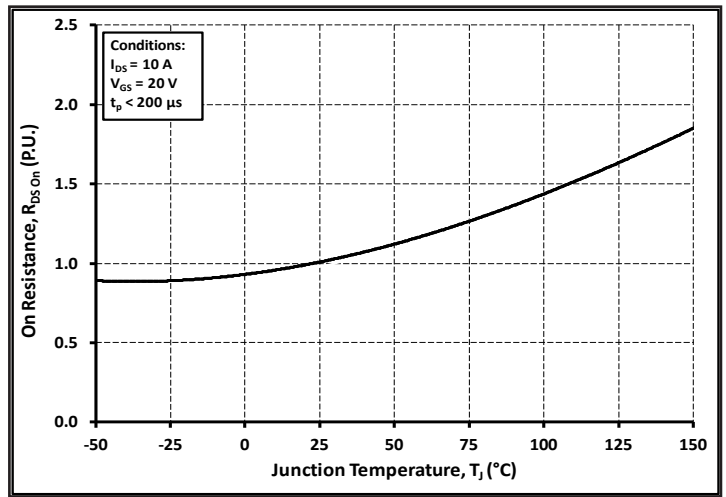

Figure 4. Normalized On-Resistance vs. Temperature

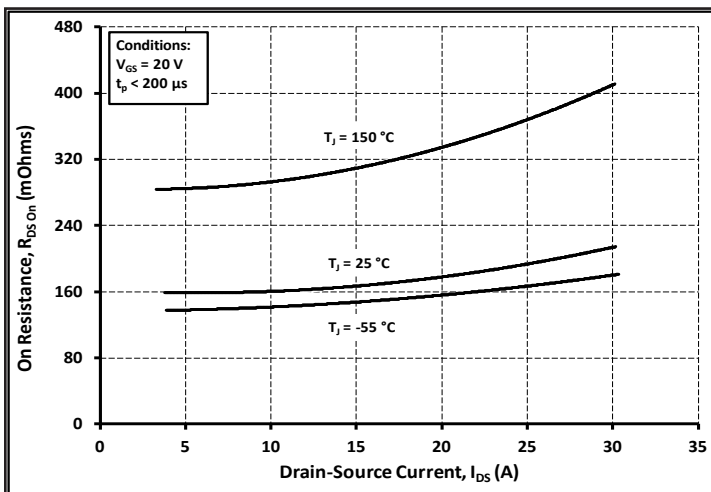

Figure 5. On-Resistance vs. Drain Current For Various Temperatures

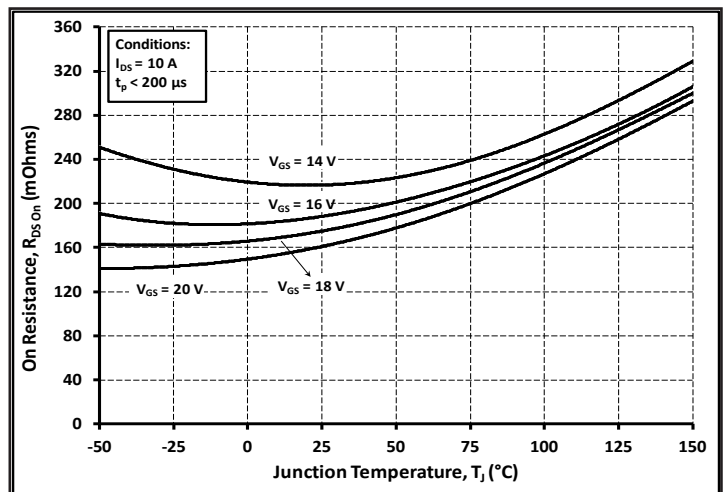

Figure 6. On-Resistance vs. Temperature For Various Gate Voltage

Typical Performance

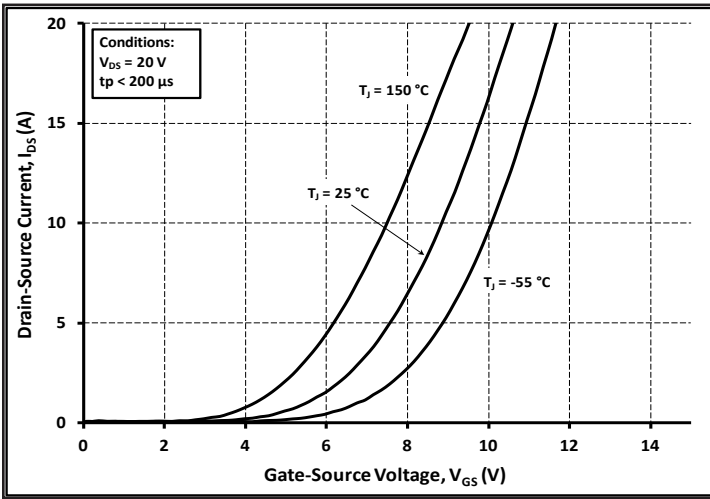

Figure 7. Transfer Characteristic for Various Junction Temperatures

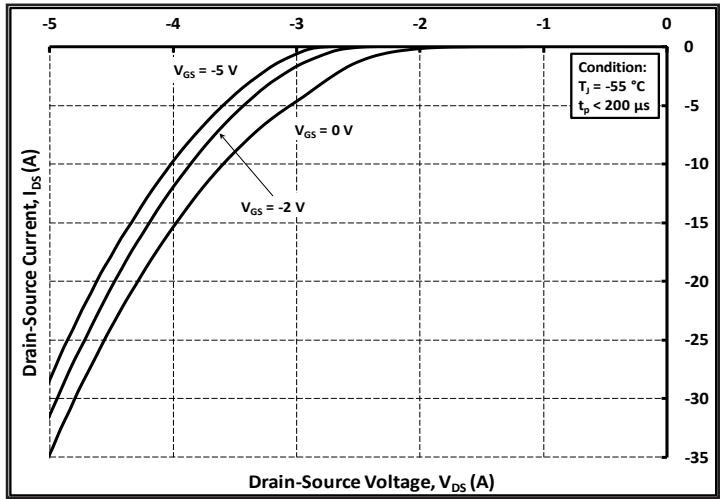

Figure 8. Body Diode Characteristic at -55 °C

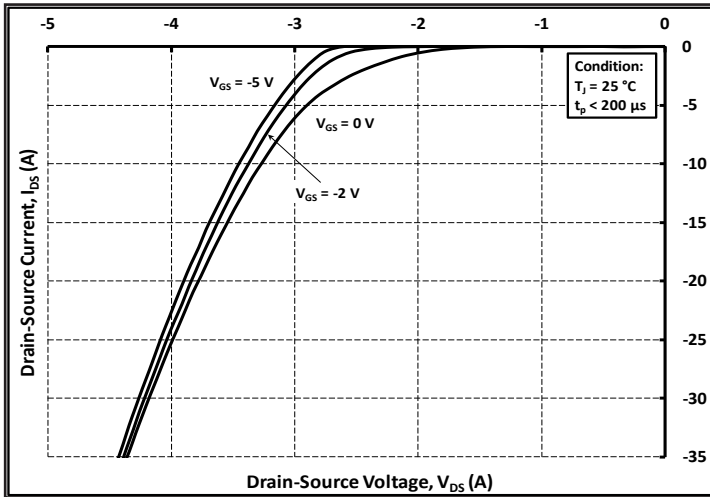

Figure 9. Body Diode Characteristic at 25 °C

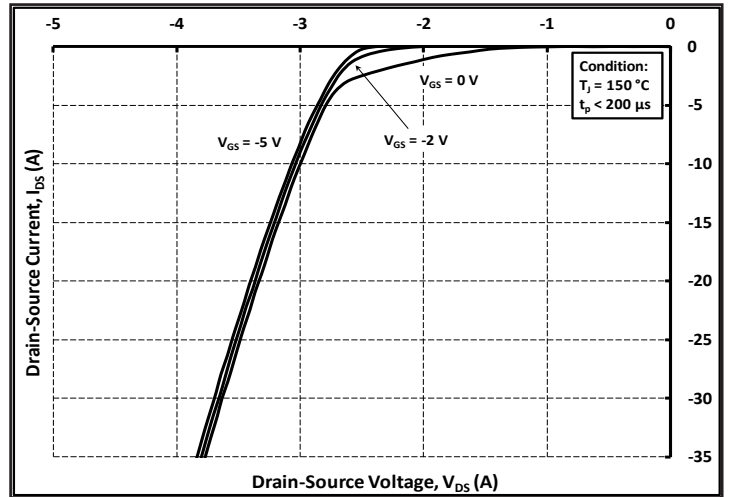

Figure 10. Body Diode Characteristic at 150 °C

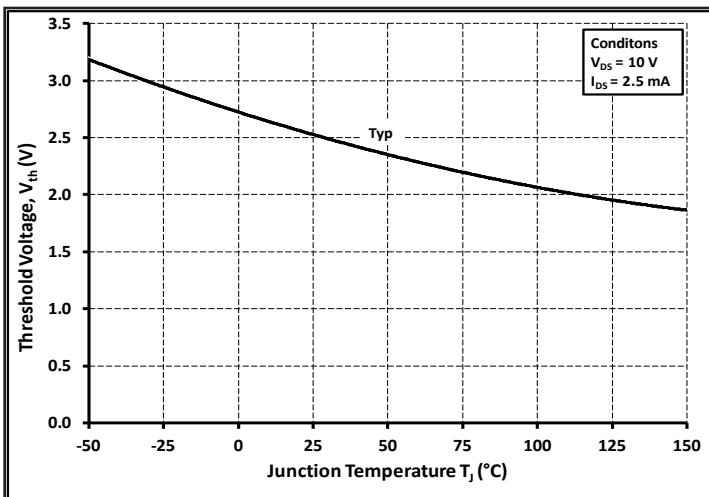

Figure 11. Threshold Voltage vs. Temperature

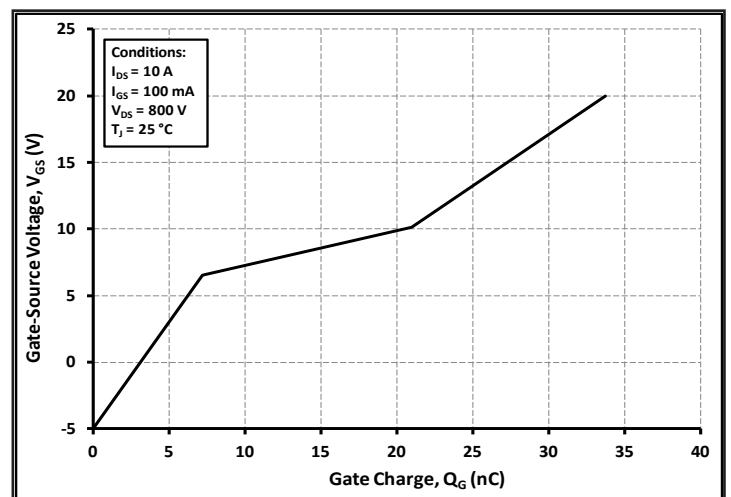

Figure 12. Gate Charge Characteristics

Typical Performance

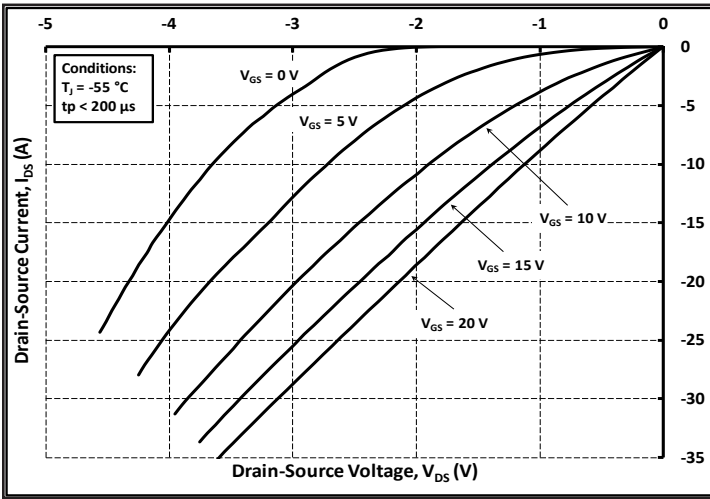

Figure 13. 3rd Quadrant Characteristic at $-55\text{ }^\circ\text{C}$

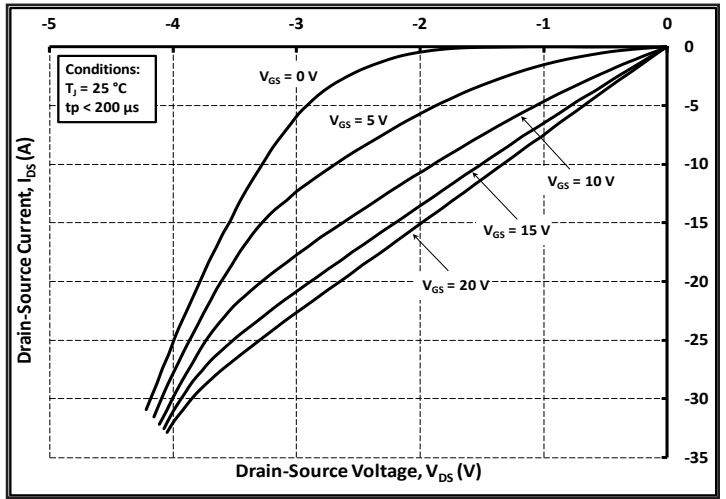

Figure 14. 3rd Quadrant Characteristic at $25\text{ }^\circ\text{C}$

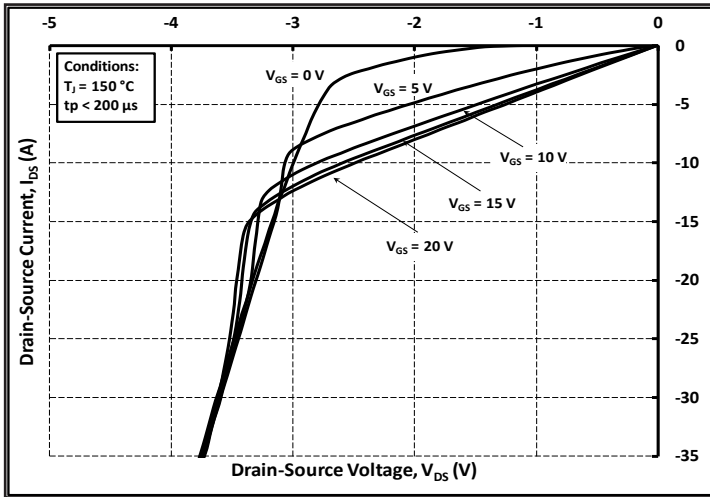

Figure 15. 3rd Quadrant Characteristic at $150\text{ }^\circ\text{C}$

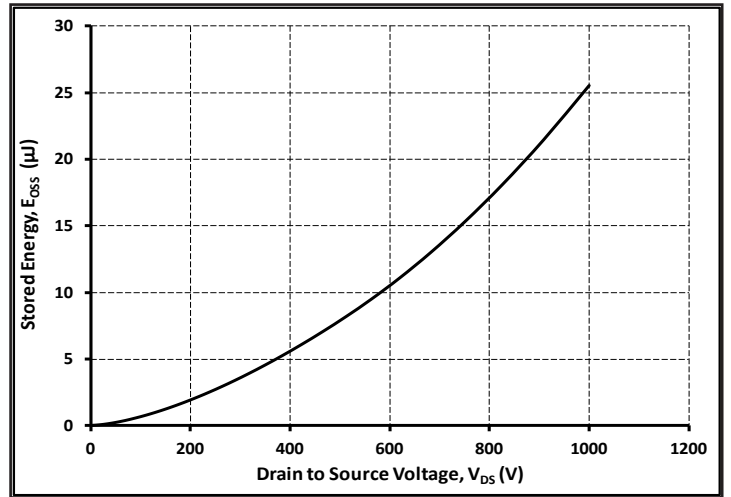

Figure 16. Output Capacitor Stored Energy

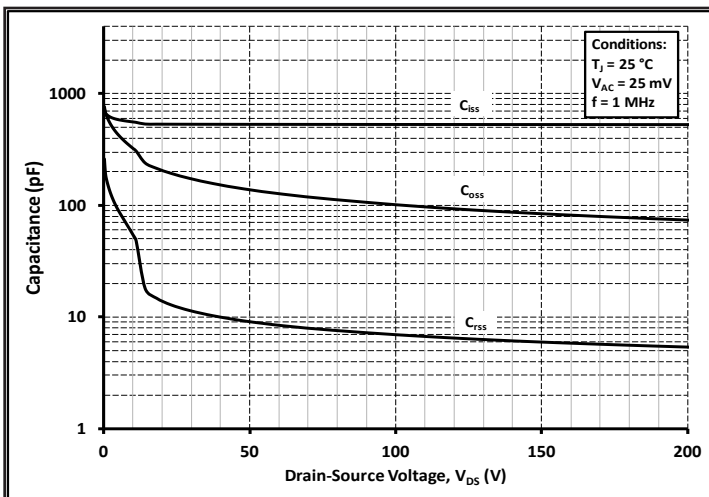

Figure 17. Capacitances vs. Drain-Source Voltage (0 - 200V)

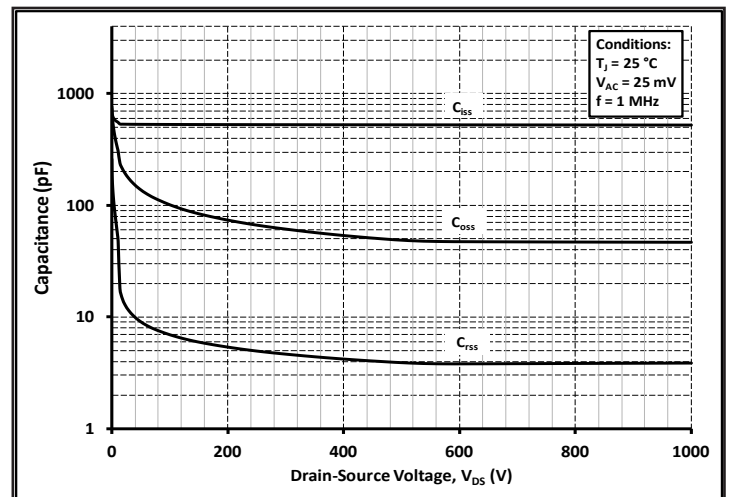

Figure 18. Capacitances vs. Drain-Source Voltage (0 - 1000V)

Typical Performance

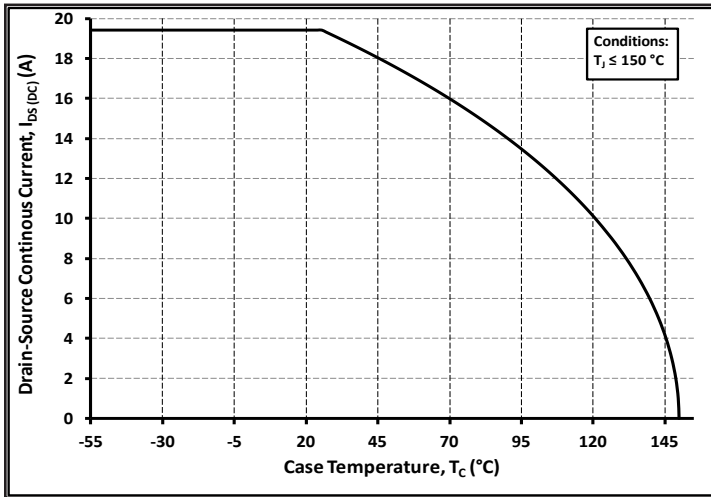

Figure 19. Continuous Drain Current Derating vs. Case Temperature

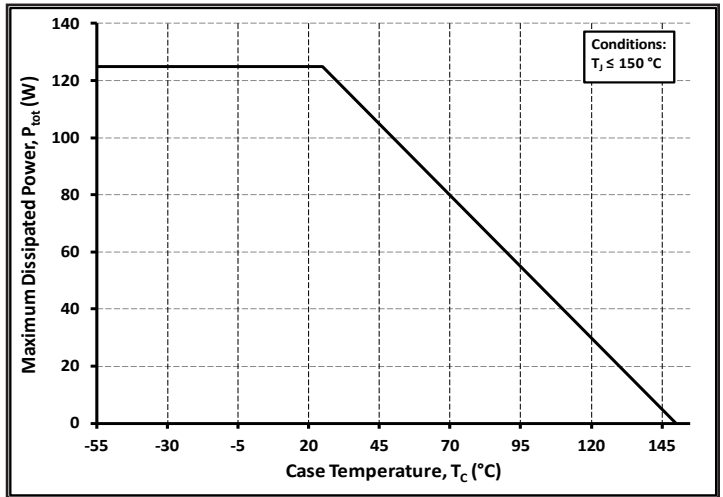

Figure 20. Maximum Power Dissipation Derating vs. Case Temperature

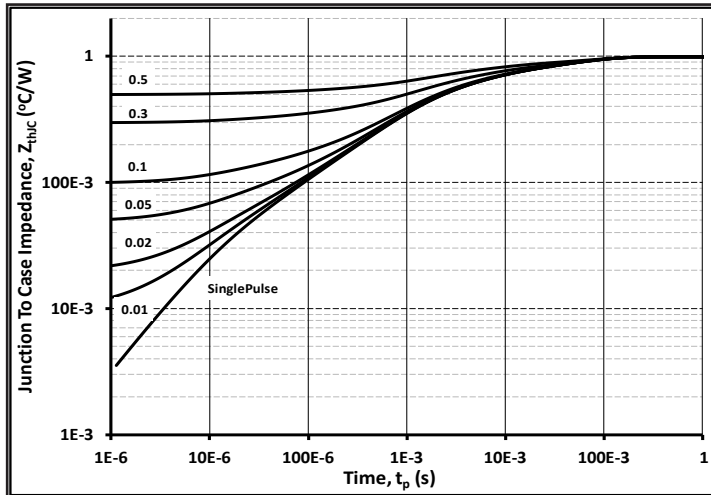

Figure 21. Transient Thermal Impedance (Junction - Case)

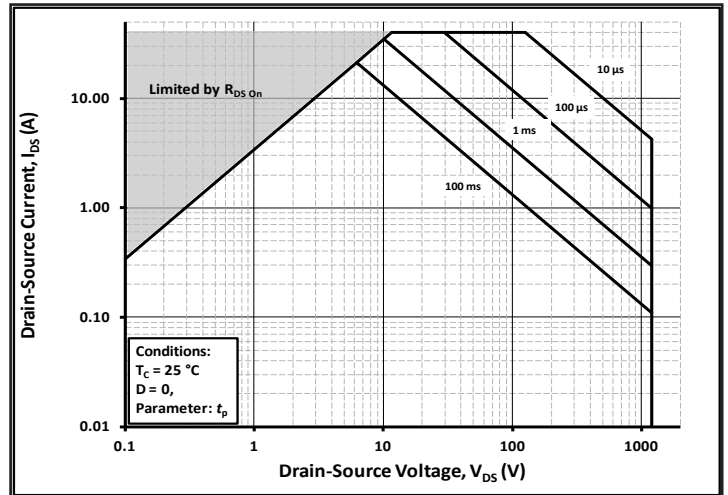

Figure 22. Safe Operating Area

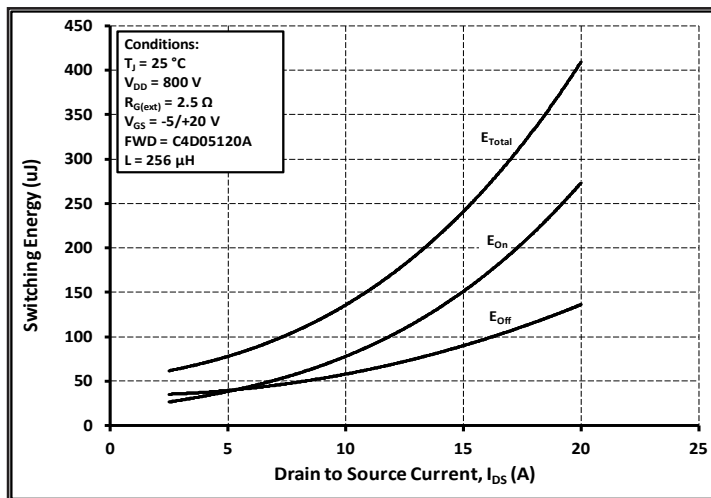

Figure 23. Clamped Inductive Switching Energy vs. Drain Current ($V_{DS} = 800 \text{ V}$)

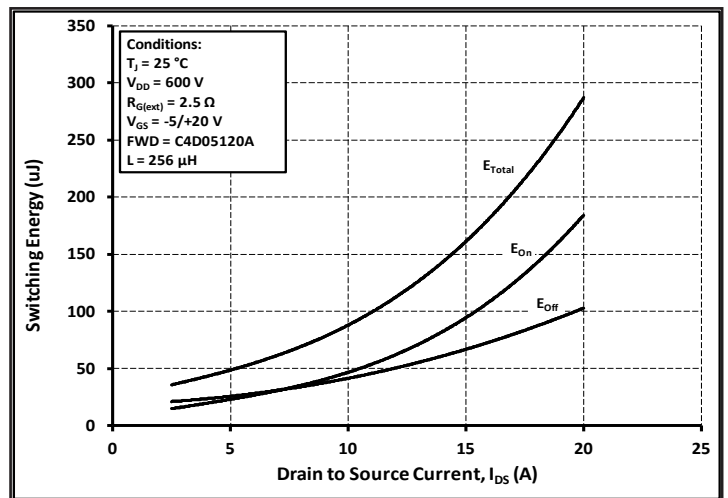

Figure 24. Clamped Inductive Switching Energy vs. Drain Current ($V_{DS} = 600 \text{ V}$)

Typical Performance

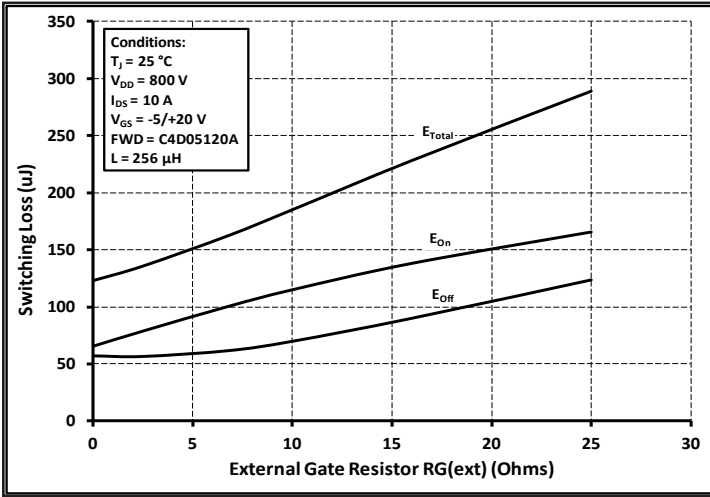

Figure 25. Clamped Inductive Switching Energy vs. $R_{G(ext)}$

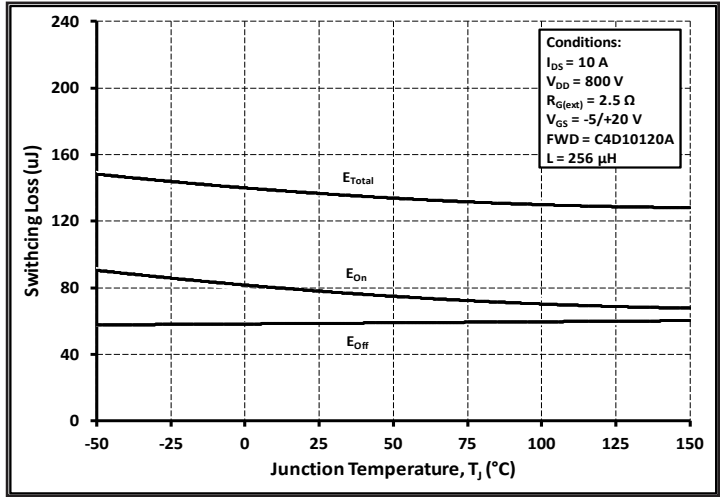

Figure 26. Clamped Inductive Switching Energy vs. Temperature

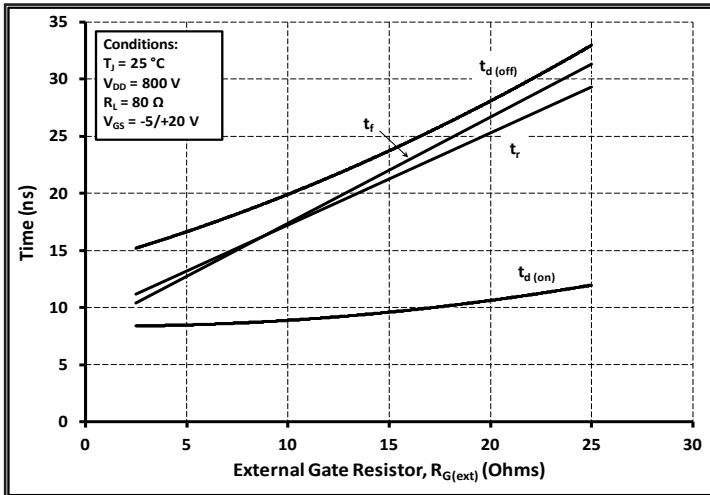

Figure 27. Switching Times vs. $R_{G(ext)}$

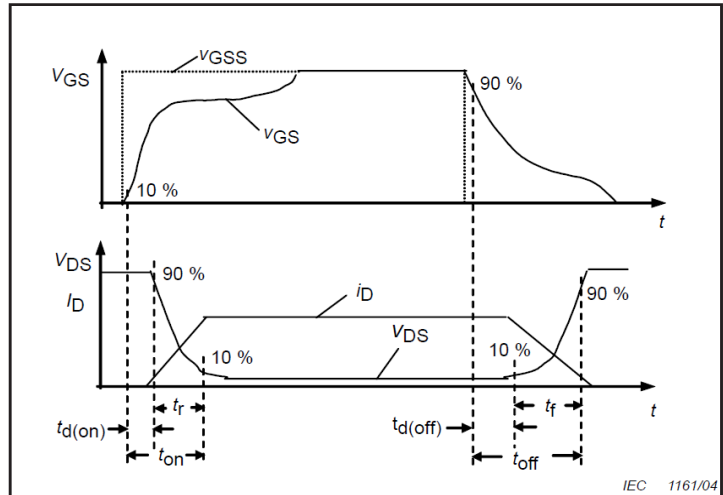

Figure 28. Switching Times Definition

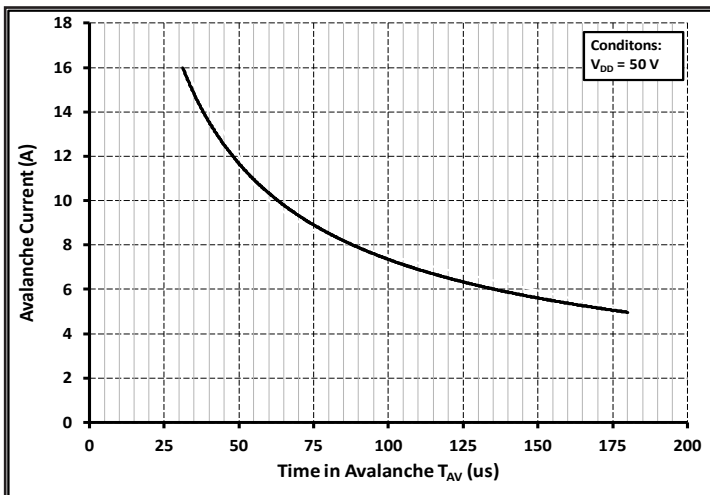

Figure 29. Single Avalanche SOA curve

Test Circuit Schematic

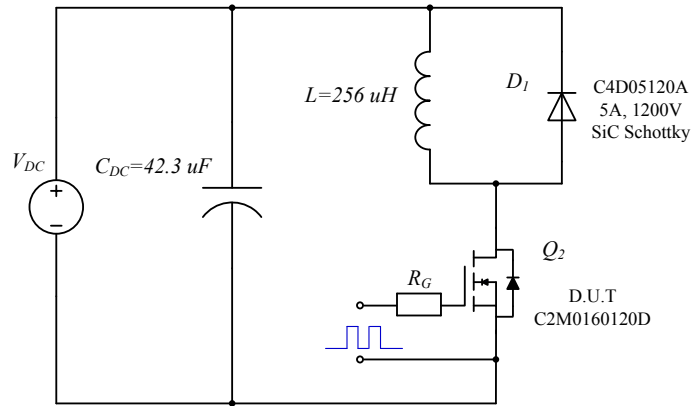

Figure 30. Clamped Inductive Switching Waveform Test Circuit

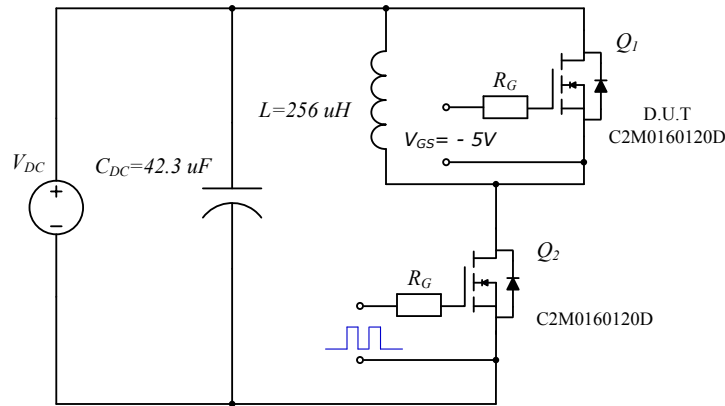

Figure 31. Body Diode Recovery Test Circuit

ESD Ratings

ESD Test	Total Devices Sampled	Resulting Classification
ESD-HBM	All Devices Passed 1000V	2 (>2000V)
ESD-MM	All Devices Passed 400V	C (>400V)
ESD-CDM	All Devices Passed 1000V	IV (>1000V)

Package Dimensions

Package TO-247-3

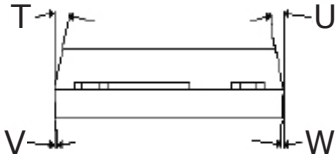
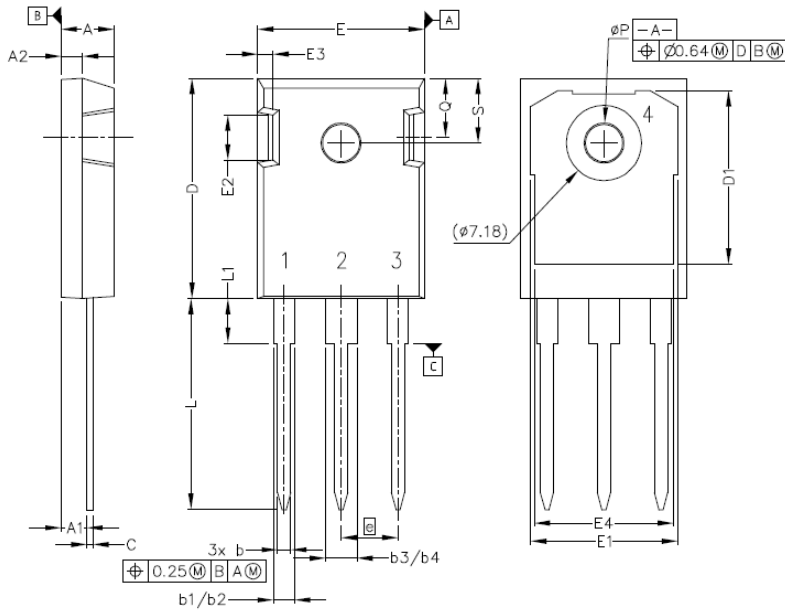

Pinout Information:

- Pin 1 = Gate
- Pin 2, 4 = Drain
- Pin 3 = Source

POS	Inches		Millimeters	
	Min	Max	Min	Max
A	.190	.205	4.83	5.21
A1	.090	.100	2.29	2.54
A2	.075	.085	1.91	2.16
b	.042	.052	1.07	1.33
b1	.075	.095	1.91	2.41
b2	.075	.085	1.91	2.16
b3	.113	.133	2.87	3.38
b4	.113	.123	2.87	3.13
c	.022	.027	0.55	0.68
D	.819	.831	20.80	21.10
D1	.640	.695	16.25	17.65
D2	.037	.049	0.95	1.25
E	.620	.635	15.75	16.13
E1	.516	.557	13.10	14.15
E2	.145	.201	3.68	5.10
E3	.039	.075	1.00	1.90
E4	.487	.529	12.38	13.43
e	.214 BSC		5.44 BSC	
N	3		3	
L	.780	.800	19.81	20.32
L1	.161	.173	4.10	4.40
ØP	.138	.144	3.51	3.65
Q	.216	.236	5.49	6.00
S	.238	.248	6.04	6.30
T	9°	11°	9°	11°
U	9°	11°	9°	11°
V	2°	8°	2°	8°
W	2°	8°	2°	8°

Recommended Solder Pad Layout

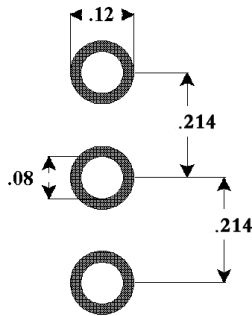

TO-247-3

Part Number	Package	Marking
C2M0160120D	TO-247-3	C2M0160120



Notes

- **RoHS Compliance**

The levels of RoHS restricted materials in this product are below the maximum concentration values (also referred to as the threshold limits) permitted for such substances, or are used in an exempted application, in accordance with EU Directive 2011/65/EC (RoHS2), as implemented January 2, 2013. RoHS Declarations for this product can be obtained from your Cree representative or from the Product Documentation sections of www.cree.com.

- **REACH Compliance**

REACH substances of high concern (SVHCs) information is available for this product. Since the European Chemical Agency (ECHA) has published notice of their intent to frequently revise the SVHC listing for the foreseeable future, please contact a Cree representative to insure you get the most up-to-date REACH SVHC Declaration. REACH banned substance information (REACH Article 67) is also available upon request.

- This product has not been designed or tested for use in, and is not intended for use in, applications implanted into the human body nor in applications in which failure of the product could lead to death, personal injury or property damage, including but not limited to equipment used in the operation of nuclear facilities, life-support machines, cardiac defibrillators or similar emergency medical equipment, aircraft navigation or communication or control systems, air traffic control systems.

Related Links

- **C2M PSPICE Models:** www.cree.com/power
- **SiC MOSFET Isolated Gate Driver reference design:** www.cree.com/power
- **Application Considerations for Silicon-Carbide MOSFETs:** www.cree.com/power