

EVA-D

~16° diffused spot beam

TECHNICAL SPECIFICATIONS:

Dimensions	Ø 35.0 mm
Height	16.4 mm
Fastening	glue
Colour	clear
Box size	
Box weight	4 kg
Quantity in Box	540 pcs
ROHS compliant	yes ⓘ



MATERIAL SPECIFICATIONS:

Component	Type	Material	Colour
EVA-D	Single lens	PMMA	clear

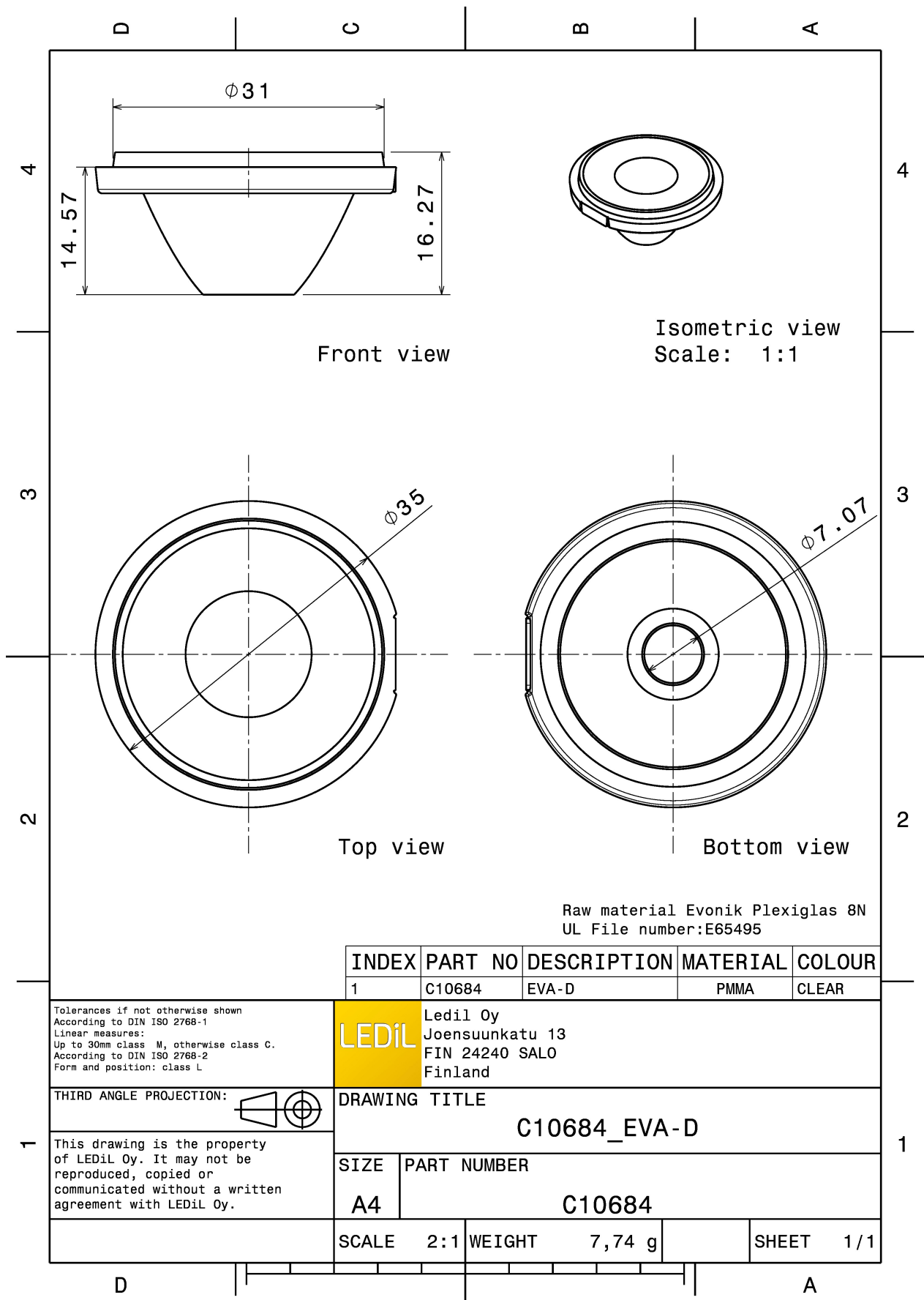

INDEX	PART NO	DESCRIPTION	MATERIAL	COLOUR
1	C10684	EVA-D	PMMA	CLEAR

Tolerances if not otherwise shown
According to DIN ISO 2768-1
Linear measures:
Up to 30mm class M, otherwise class C.
According to DIN ISO 2768-2
Form and position: class L

LEDiL Oy
Joensuunkatu 13
FIN 24240 SALO
Finland

THIRD ANGLE PROJECTION:

DRAWING TITLE
C10684_EVA-D

This drawing is the property of LEDiL Oy. It may not be reproduced, copied or communicated without a written agreement with LEDiL Oy.

SIZE	PART NUMBER
A4	C10684

SCALE	2:1	WEIGHT	7,74 g	SHEET	1/1
-------	-----	--------	--------	-------	-----

PHOTOMETRIC DATA (MEASURED):

CITIZEN

LED CLU LES 4.2mm (HI-Ver.3)
 FWHM 16.0°
 Efficiency 92 %
 Peak intensity 7.500 cd/lm
 LEDs/each optic 1
 Light colour White
 Required components:

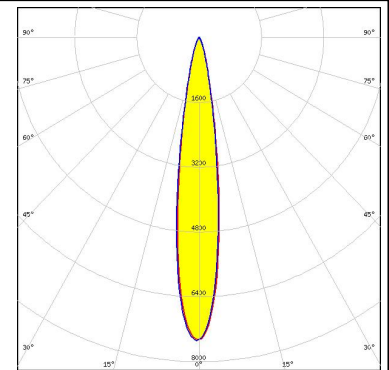

CREE

LED MC-E
 FWHM 16.0°
 Efficiency 92 %
 Peak intensity 6.000 cd/lm
 LEDs/each optic 1
 Light colour White
 Required components:

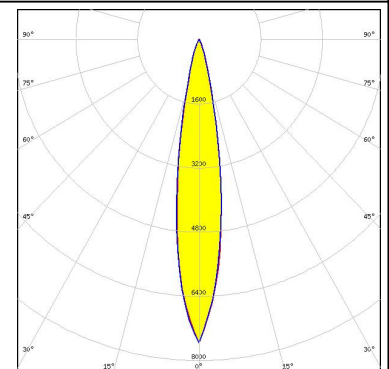
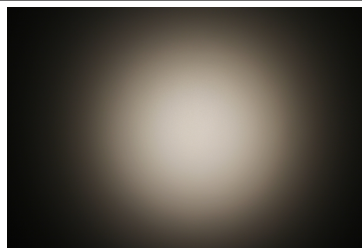

CREE

LED MHB-A/B
 FWHM 19.0°
 Efficiency 83 %
 Peak intensity 5.400 cd/lm
 LEDs/each optic 1
 Light colour White
 Required components:

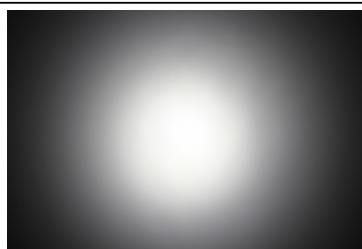

CREE

LED XHP35 HI
 FWHM 22.0°
 Efficiency 79 %
 Peak intensity 3.900 cd/lm
 LEDs/each optic 1
 Light colour White
 Required components:

PHOTOMETRIC DATA (MEASURED):

CREE

LED XM-L
 FWHM 16.0°
 Efficiency 91 %
 Peak intensity cd/lm
 LEDs/each optic 1
 Light colour White
 Required components:

CREE

LED XP-G2
 FWHM 16.0°
 Efficiency 87 %
 Peak intensity cd/lm
 LEDs/each optic 1
 Light colour White
 Required components:

CREE

LED XT-E
 FWHM 14.0°
 Efficiency %
 Peak intensity 7.500 cd/lm
 LEDs/each optic 1
 Light colour White
 Required components:

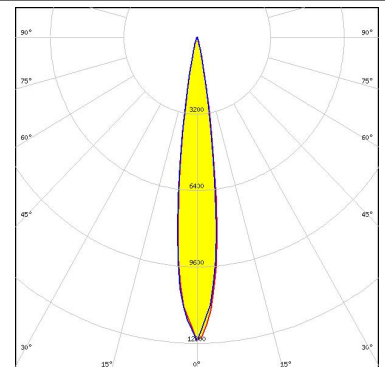

LUMILEDS

LED LUXEON 5050
 FWHM 18.0°
 Efficiency 91 %
 Peak intensity 6.400 cd/lm
 LEDs/each optic 1
 Light colour White
 Required components:

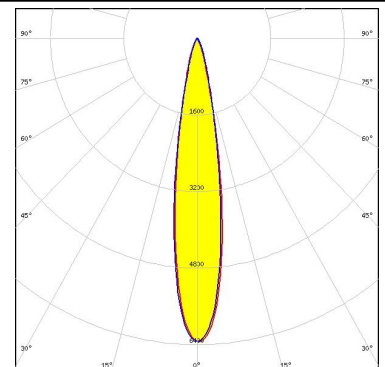

PHOTOMETRIC DATA (MEASURED):

LUMILEDS

LED LUXEON M/MX
 FWHM 21.0°
 Efficiency 90 %
 Peak intensity 4.200 cd/lm
 LEDs/each optic 1
 Light colour White
 Required components:

LUMILEDS

LED LUXEON MZ
 FWHM 16.0°
 Efficiency 88 %
 Peak intensity 7.800 cd/lm
 LEDs/each optic 1
 Light colour White
 Required components:

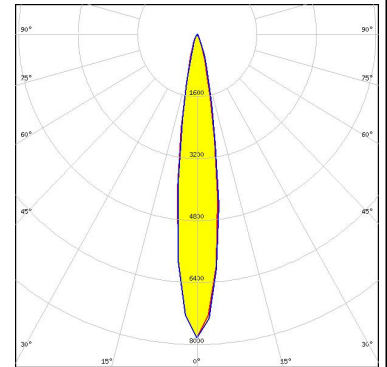
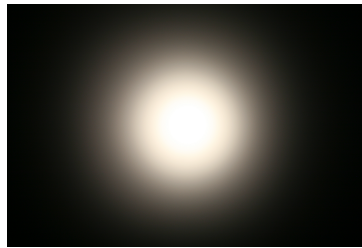

NICHIA

LED NS9x383
 FWHM 16.0°
 Efficiency 89 %
 Peak intensity 6.800 cd/lm
 LEDs/each optic 1
 Light colour White
 Required components:

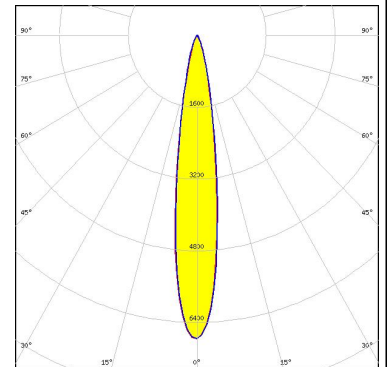

NICHIA

LED NSMx286M
 FWHM 20.0°
 Efficiency 91 %
 Peak intensity 4.400 cd/lm
 LEDs/each optic 1
 Light colour White
 Required components:

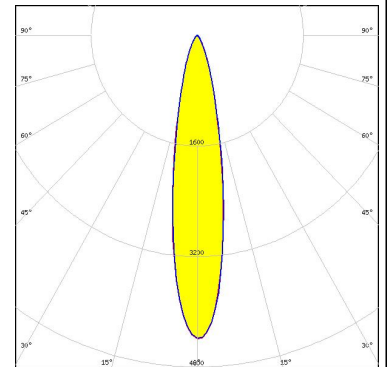

PHOTOMETRIC DATA (MEASURED):

OSRAM
Opto Semiconductors

LED Duris S8
FWHM 18.0°
Efficiency 84 %
Peak intensity 6.200 cd/lm
LEDs/each optic 1
Light colour White
Required components:

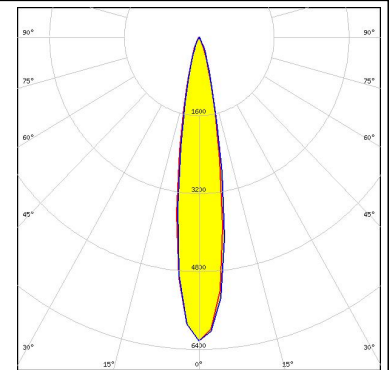

SEOL
SEOL SEMICONDUCTOR

LED Z8Y15
FWHM 13.0°
Efficiency 86 %
Peak intensity 11.530 cd/lm
LEDs/each optic 1
Light colour White
Required components:



SEOL
SEOL SEMICONDUCTOR

LED Z8Y19
FWHM 13.0°
Efficiency 87 %
Peak intensity 11.000 cd/lm
LEDs/each optic 1
Light colour White
Required components:

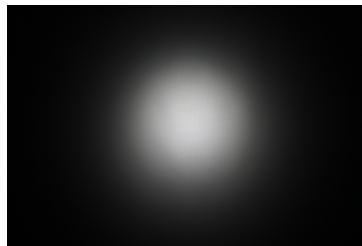

PHOTOMETRIC DATA (SIMULATED):



LED LUXEON 5258
FWHM 17.0°
Efficiency 92 %
Peak intensity 8.600 cd/lm
LEDs/each optic 1
Light colour White
Required components:

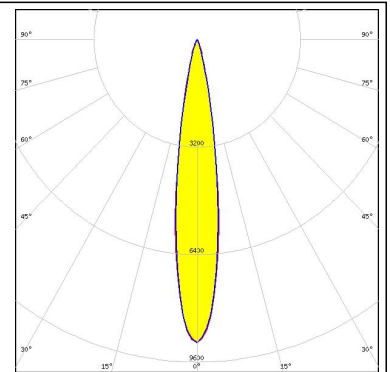

LED OSCONIQ P 7070
FWHM 20.0°
Efficiency 94 %
Peak intensity 6.850 cd/lm
LEDs/each optic 1
Light colour White
Required components:

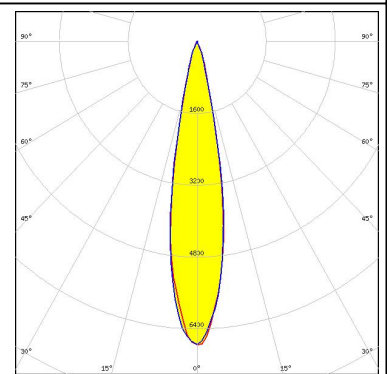

GENERAL INFORMATION:

NOTE: The typical beam angle will be changed by different color, chip size and chip position tolerance. The typical total beam angle is the full angle measured where the luminous intensity is half of the peak value.

Due to use of high power COB's with this product, special attention to proper thermal design is highly recommended. LEDiL has no liability for direct, indirect or consecutive damages arising from the LEDiL products being used outside of the recommended temperature range.

MATERIALS:

As part of our continuous research and improvement processes, and to ensure the best possible quality and availability of our products, LEDiL reserves the right to change material grades without notice.

PRODUCT DATA USER AGREEMENT AND DISCLAIMER:

The measured data in the provided downloadable LEDiL Product Datasheets and Mechanical 2D-Drawings is rounded and provided as reference for planning. LEDiL Oy's optical specifications have been verified by conducting performance testing of the products in accordance with the company's quality system. The reported data are averaged results of multiple measurements with typical variation. LEDiL Oy reserves the right to without prior notification make changes and improvements to its products.

LEDiL Oy assumes neither warranty, nor guarantee nor any other liability of any kind for the contents and correctness of the provided data. The provided data has been generated with highest diligence but the provided data may in reality not represent the complete possible variation range of all intrinsic parameters. Therefore, in certain cases a deviation from the provided data could occur.

LEDiL Oy reserves the right to undertake technical changes of its products without further notification which could lead to changes in the provided data. LEDiL Oy assumes no liability of any kind for the possible deviation from any provided data or any other damage resulting from the usage of the provided data.

The user agrees to this disclaimer and user agreement with the download or usage of the provided files.

LEDiL Oy

Joensuunkatu 13
FI-24240 SALO
Finland

LEDiL Inc.

228 West Page Street
Suite D
Sycamore IL 60178
USA

Local sales and technical support

[www.ledil.com/
where_to_buy](http://www.ledil.com/where_to_buy)

Shipping locations

Salo, Finland
Hong Kong, China

Distribution Partners

[www.ledil.com/
where_to_buy](http://www.ledil.com/where_to_buy)