

## Features

- $BV_{CEO} > 45V, 60V \text{ \& } 80V$
- $I_C = 1A$  Continuous Collector Current
- $I_{CM} = 1.5A$  Peak Pulse Current
- Low Saturation Voltage  $V_{CE(sat)} < 500mV @ 0.5A$
- Gain Groups 10 and 16
- Epitaxial Planar Die Construction
- Complementary PNP types: BCX51, 52, and 53
- **Totally Lead-Free & Fully RoHS compliant (Notes 1 & 2)**
- **Halogen and Antimony Free. "Green" Device (Note 3)**
- **Qualified to AEC-Q101 Standards for High Reliability**

## Mechanical Data

- Case: SOT89
- Case Material: Molded Plastic, "Green" Molding Compound  
UL Flammability Rating 94V-0
- Moisture Sensitivity: Level 1 per J-STD-020
- Terminals: Matte Tin Finish Leads, Solderable per MIL-STD-202 Method 208 **(e3)**
- Weight: 0.055 grams (Approximate)

## Applications

- Medium Power Switching or Amplification Applications
- AF driver and output stages

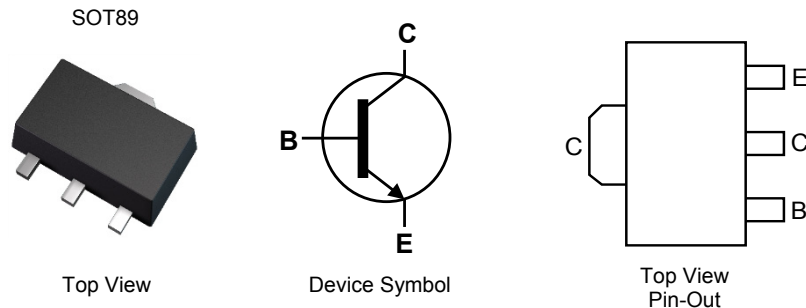

## Ordering Information (Note 4)

Product	Compliance	Marking	Reel size (inches)	Tape width (mm)	Quantity per reel
BCX54TA	AEC-Q101	BA	7	12	1,000
BCX5410TA	AEC-Q101	BC	7	12	1,000
BCX5416TA	AEC-Q101	BD	7	12	1,000
BCX5416-13R	AEC-Q101	BD	13	12	4,000
BCX55TA	AEC-Q101	BE	7	12	1,000
BCX5510TA	AEC-Q101	BG	7	12	1,000
BCX5516TA	AEC-Q101	BM	7	12	1,000
BCX56TA	AEC-Q101	BH	7	12	1,000
BCX5610TA	AEC-Q101	BK	7	12	1,000
BCX5616TA	AEC-Q101	BL	7	12	1,000
BCX5616TC	AEC-Q101	BL	13	12	4,000

- Notes:
1. No purposely added lead. Fully EU Directive 2002/95/EC (RoHS) & 2011/65/EU (RoHS 2) compliant.
  2. See [http://www.diodes.com/quality/lead\\_free.html](http://www.diodes.com/quality/lead_free.html) for more information about Diodes Incorporated's definitions of Halogen- and Antimony-free, "Green" and Lead-free.
  3. Halogen- and Antimony-free "Green" products are defined as those which contain <900ppm bromine, <900ppm chlorine (<1500ppm total Br + Cl) and <1000ppm antimony compounds.
  4. For packaging details, go to our website at <http://www.diodes.com/products/packages.html>

## Marking Information

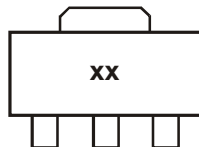

xx = Product Type Marking Code, as follows:

BCX54 = BA	BCX55 = BE	BCX56 = BH
BCX5410 = BC	BCX5510 = BG	BCX5610 = BK
BCX5416 = BD	BCX5516 = BM	BCX5616 = BL

### Absolute Maximum Ratings (@ T<sub>A</sub> = +25°C, unless otherwise specified.)

Characteristic	Symbol	BCX54	BCX55	BCX56	Unit
Collector-Base Voltage	V <sub>CBO</sub>	45	60	100	V
Collector-Emitter Voltage	V <sub>CEO</sub>	45	60	80	V
Emitter-Base Voltage	V <sub>EBO</sub>	6			V
Continuous Collector Current	I <sub>C</sub>	1			A
Peak Pulse Collector Current	I <sub>CM</sub>	1.5			
Continuous Base Current	I <sub>B</sub>	100			mA
Peak Pulse Base Current	I <sub>BM</sub>	200			

### Thermal Characteristics (@T<sub>A</sub> = +25°C, unless otherwise specified.)

Characteristic	Symbol	Value	Unit
Power Dissipation	(Note 5)	1	W
	(Note 6)	1.5	
	(Note 7)	2.0	
Thermal Resistance, Junction to Ambient Air	(Note 5)	125	°C/W
	(Note 6)	83	
	(Note 7)	60	
Thermal Resistance, Junction to Lead	R <sub>θJL</sub>	13	°C/W
Operating and Storage Temperature Range	T <sub>J</sub> , T <sub>STG</sub>	-65 to +150	°C

### ESD Ratings (Note 9)

Characteristic	Symbol	Value	Unit	JEDEC Class
Electrostatic Discharge - Human Body Model	ESD HBM	4,000	V	3A
Electrostatic Discharge - Machine Model	ESD MM	400	V	C

- Notes:
5. For a device mounted with the exposed collector pad on 15mm x 15mm 1oz copper that is on a single-sided 1.6mm FR4 PCB; device is measured under still air conditions whilst operating in a steady-state.
  6. Same as note (5), except the device is mounted on 25mm x 25mm 1oz copper.
  7. Same as note (5), except the device is mounted on 50mm x 50mm 1oz copper.
  8. Thermal resistance from junction to solder-point (on the exposed collector pad).
  9. Refer to JEDEC specification JESD22-A114 and JESD22-A115.

**Thermal Characteristics and Derating Information**

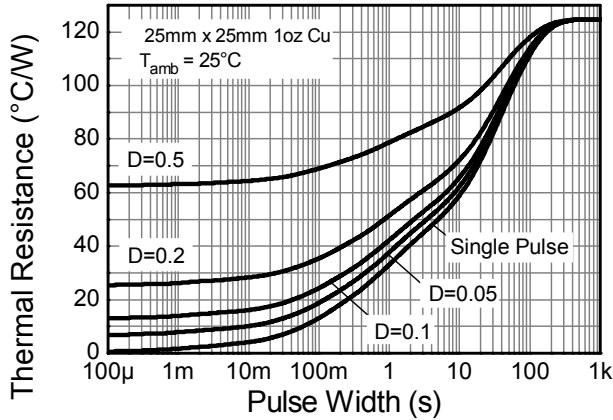

**Transient Thermal Impedance**

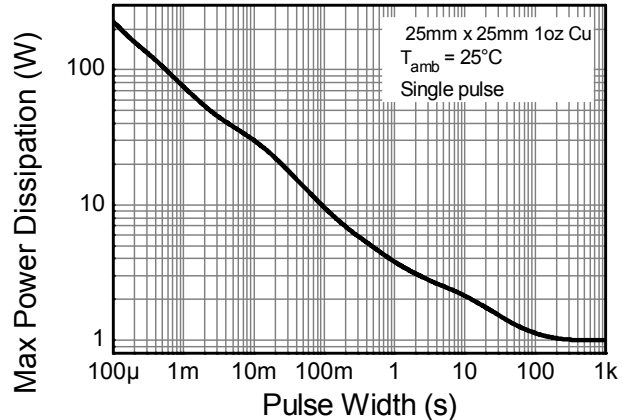

**Pulse Power Dissipation**

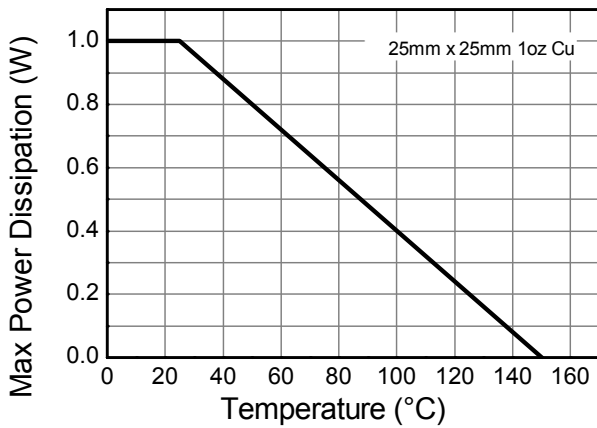

**Derating Curve**

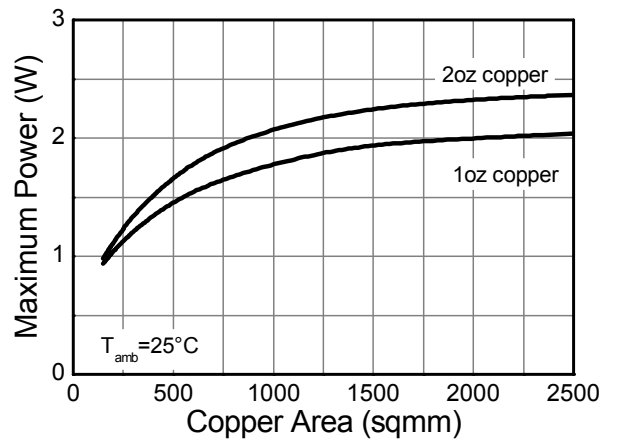
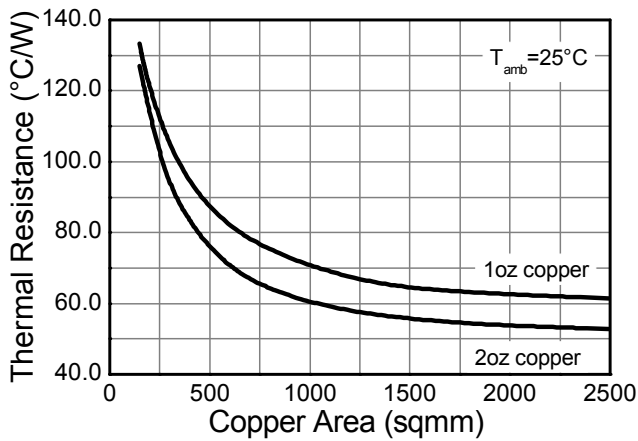

**Electrical Characteristics** (@  $T_A = +25^\circ\text{C}$ , unless otherwise specified.)

Characteristic		Symbol	Min	Typ	Max	Unit	Test Condition
Collector-Base Breakdown Voltage	BCX54	$BV_{CBO}$	45	—	—	V	$I_C = 100\mu\text{A}$
	BCX55		60				
	BCX56		100				
Collector-Emitter Breakdown Voltage (Note 10)	BCX54	$BV_{CEO}$	45	—	—	V	$I_C = 10\text{mA}$
	BCX55		60				
	BCX56		80				
Emitter-Base Breakdown Voltage		$BV_{EBO}$	6	—	—	V	$I_E = 100\mu\text{A}$
Collector Cut-off Current		$I_{CBO}$	—	—	0.1 20	$\mu\text{A}$	$V_{CB} = 30\text{V}$ $V_{CB} = 30\text{V}, T_A = +150^\circ\text{C}$
Emitter Cut-off Current		$I_{EBO}$	—	—	20	nA	$V_{EB} = 5\text{V}$
Static Forward Current Transfer Ratio (Note 10)	All versions	$h_{FE}$	25	—	—	—	$I_C = 5\text{mA}, V_{CE} = 2\text{V}$
			40	—	250		$I_C = 150\text{mA}, V_{CE} = 2\text{V}$
	25		—	—	$I_C = 500\text{mA}, V_{CE} = 2\text{V}$		
	63		—	160	$I_C = 150\text{mA}, V_{CE} = 2\text{V}$		
	10 gain grp		100	—	250		$I_C = 150\text{mA}, V_{CE} = 2\text{V}$
	16 gain grp						
Collector-Emitter Saturation Voltage (Note 10)		$V_{CE(sat)}$	—	—	0.5	V	$I_C = 500\text{mA}, I_B = 50\text{mA}$
Base-Emitter Turn-On Voltage (Note 10)		$V_{BE(on)}$	—	—	1.0	V	$I_C = 500\text{mA}, V_{CE} = 2\text{V}$
Transition Frequency		$f_T$	150	—	—	MHz	$I_C = 50\text{mA}, V_{CE} = 10\text{V}$ $f = 100\text{MHz}$
Output Capacitance		$C_{obo}$	—	—	25	pF	$V_{CB} = 10\text{V}, f = 1\text{MHz}$

Note: 10. Measured under pulsed conditions. Pulse width  $\leq 300\mu\text{s}$ . Duty cycle  $\leq 2\%$ .

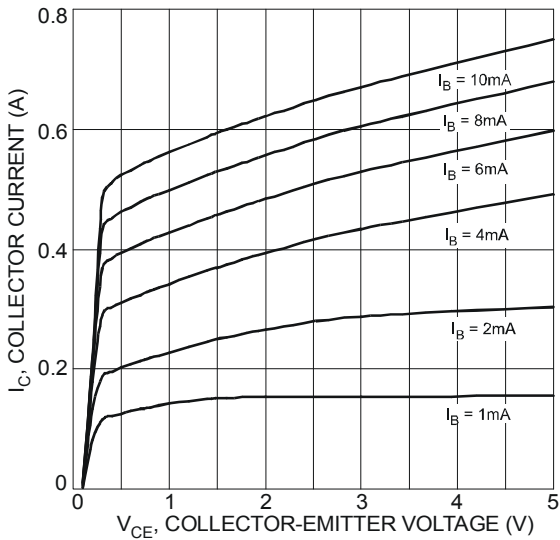

Fig. 1 Typical Collector Current vs. Collector-Emitter Voltage

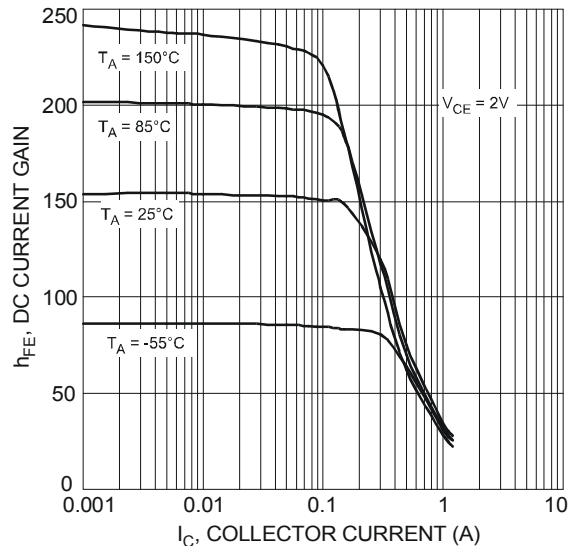

Fig. 2 Typical DC Current Gain vs. Collector Current

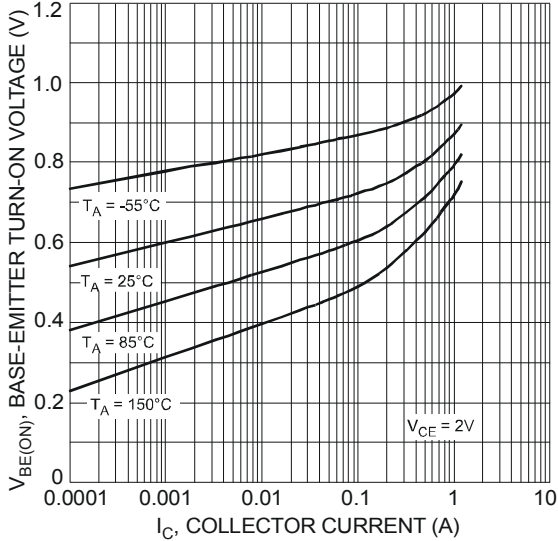

Fig. 3 Typical Base-Emitter Turn-On Voltage vs. Collector Current

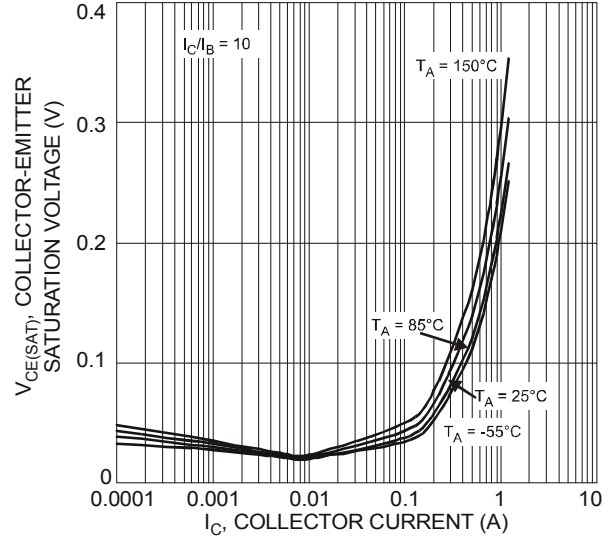

Fig. 4 Typical Collector-Emitter Saturation Voltage vs. Collector Current

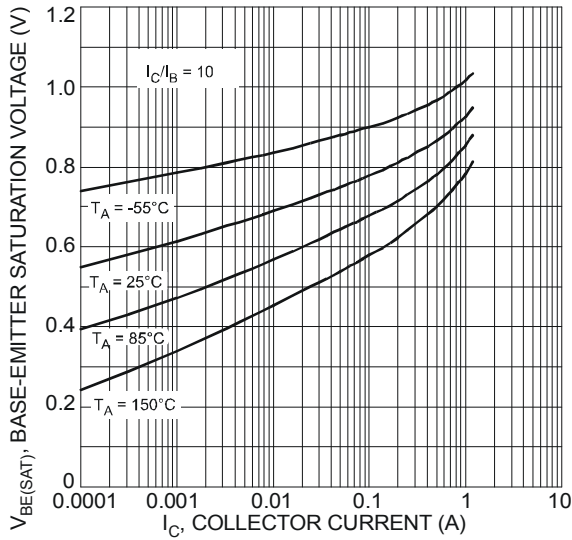

Fig. 5 Typical Base-Emitter Saturation Voltage vs. Collector Current

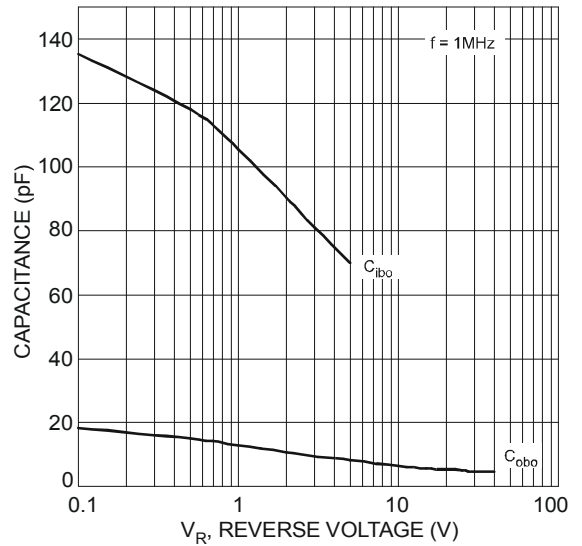

Fig. 6 Typical Capacitance Characteristics

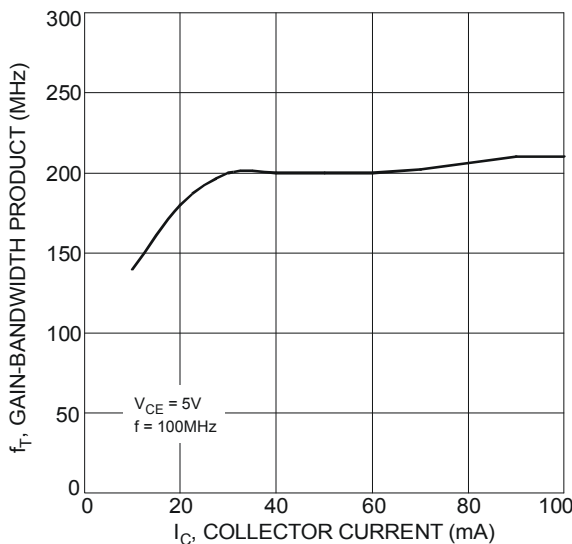
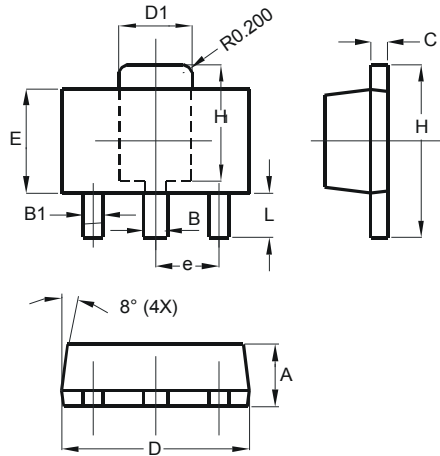

Fig. 7 Typical Gain-Bandwidth Product vs. Collector Current

## Package Outline Dimensions

Please see AP02002 at <http://www.diodes.com/datasheets/ap02002.pdf> for latest version.



SOT89		
Dim	Min	Max
A	1.40	1.60
B	0.44	0.62
B1	0.35	0.54
C	0.35	0.44
D	4.40	4.60
D1	1.62	1.83
E	2.29	2.60
e	1.50 Typ	
H	3.94	4.25
H1	2.63	2.93
L	0.89	1.20
All Dimensions in mm		

## Suggested Pad Layout

Please see AP02001 at <http://www.diodes.com/datasheets/ap02001.pdf> for the latest version.

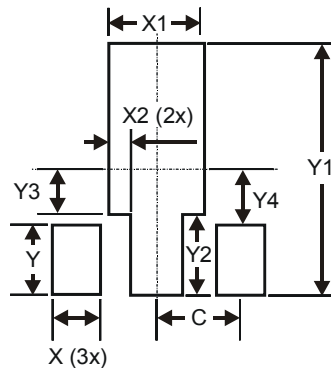

Dimensions	Value (in mm)
X	0.900
X1	1.733
X2	0.416
Y	1.300
Y1	4.600
Y2	1.475
Y3	0.950
Y4	1.125
C	1.500

**IMPORTANT NOTICE**

DIODES INCORPORATED MAKES NO WARRANTY OF ANY KIND, EXPRESS OR IMPLIED, WITH REGARDS TO THIS DOCUMENT, INCLUDING, BUT NOT LIMITED TO, THE IMPLIED WARRANTIES OF MERCHANTABILITY AND FITNESS FOR A PARTICULAR PURPOSE (AND THEIR EQUIVALENTS UNDER THE LAWS OF ANY JURISDICTION).

Diodes Incorporated and its subsidiaries reserve the right to make modifications, enhancements, improvements, corrections or other changes without further notice to this document and any product described herein. Diodes Incorporated does not assume any liability arising out of the application or use of this document or any product described herein; neither does Diodes Incorporated convey any license under its patent or trademark rights, nor the rights of others. Any Customer or user of this document or products described herein in such applications shall assume all risks of such use and will agree to hold Diodes Incorporated and all the companies whose products are represented on Diodes Incorporated website, harmless against all damages.

Diodes Incorporated does not warrant or accept any liability whatsoever in respect of any products purchased through unauthorized sales channel. Should Customers purchase or use Diodes Incorporated products for any unintended or unauthorized application, Customers shall indemnify and hold Diodes Incorporated and its representatives harmless against all claims, damages, expenses, and attorney fees arising out of, directly or indirectly, any claim of personal injury or death associated with such unintended or unauthorized application.

Products described herein may be covered by one or more United States, international or foreign patents pending. Product names and markings noted herein may also be covered by one or more United States, international or foreign trademarks.

This document is written in English but may be translated into multiple languages for reference. Only the English version of this document is the final and determinative format released by Diodes Incorporated.

**LIFE SUPPORT**

Diodes Incorporated products are specifically not authorized for use as critical components in life support devices or systems without the express written approval of the Chief Executive Officer of Diodes Incorporated. As used herein:

A. Life support devices or systems are devices or systems which:

1. are intended to implant into the body, or
2. support or sustain life and whose failure to perform when properly used in accordance with instructions for use provided in the labeling can be reasonably expected to result in significant injury to the user.

B. A critical component is any component in a life support device or system whose failure to perform can be reasonably expected to cause the failure of the life support device or to affect its safety or effectiveness.

Customers represent that they have all necessary expertise in the safety and regulatory ramifications of their life support devices or systems, and acknowledge and agree that they are solely responsible for all legal, regulatory and safety-related requirements concerning their products and any use of Diodes Incorporated products in such safety-critical, life support devices or systems, notwithstanding any devices- or systems-related information or support that may be provided by Diodes Incorporated. Further, Customers must fully indemnify Diodes Incorporated and its representatives against any damages arising out of the use of Diodes Incorporated products in such safety-critical, life support devices or systems.

Copyright © 2014, Diodes Incorporated

[www.diodes.com](http://www.diodes.com)