

BN 902

Self cutting threaded inserts

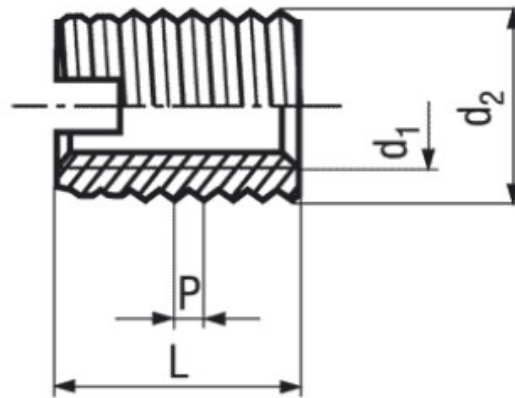

Trade mark	Ensat®	Material	Steel case-hardened
Type	302	Surface	zinc plated yellow

Article No. - 1088432	
d_1	M8
P	1,5
d_2	12
L	15

Setting tools: BN 1181 / BN 1182