

BN 57

Hexagon head bolts
partially threaded

DIN 931
ISO 4014
~UNI 5737

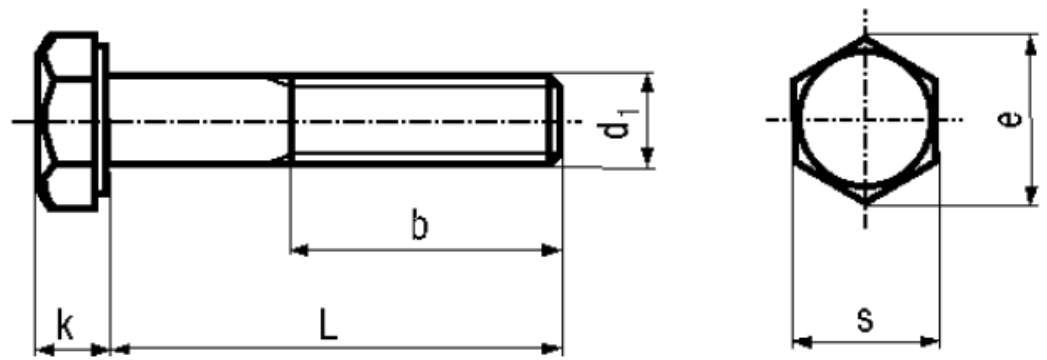

Material	Steel	Tensile strength	800 N/mm²
Surface	zinc plated blue	Proof stress 0,2%	640 N/mm²
Quality	8.8	Elongation after fracture	min. 12%

Article No. - 1049402

d ₁	M5
L	60
b	16
e	8,79
k	3,5
s	8

DIN 931: Standard withdrawn