

## BN 726 - DIN 433 - ~ISO 7092

Flat washers  
without chamfer, for screws with  
cylindrical head

DIN 433  
~ISO 7092

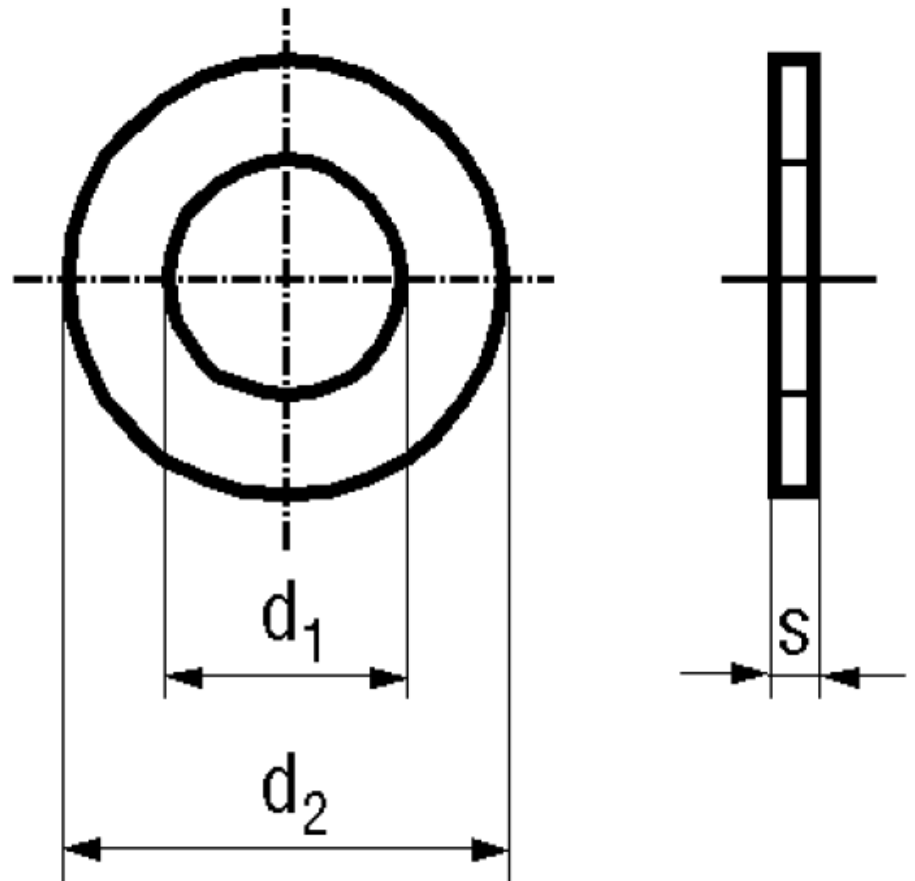

Material	Steel	Hardness grade	140 HV
Surface	zinc plated blue		

Article No. - 1269577	
for thread	M4
$d_1$	4,3
$d_2$	8
$s$	0,5

DIN 433: Standard withdrawn

M 1; M 1,2; M 1,4; M 18: Not included in ISO 7092