

BN 715 - DIN 125 A - ~ISO 7089

Flat washers
without chamfer

DIN 125 A
~ISO 7089
VSM 13904
~UNI 6592

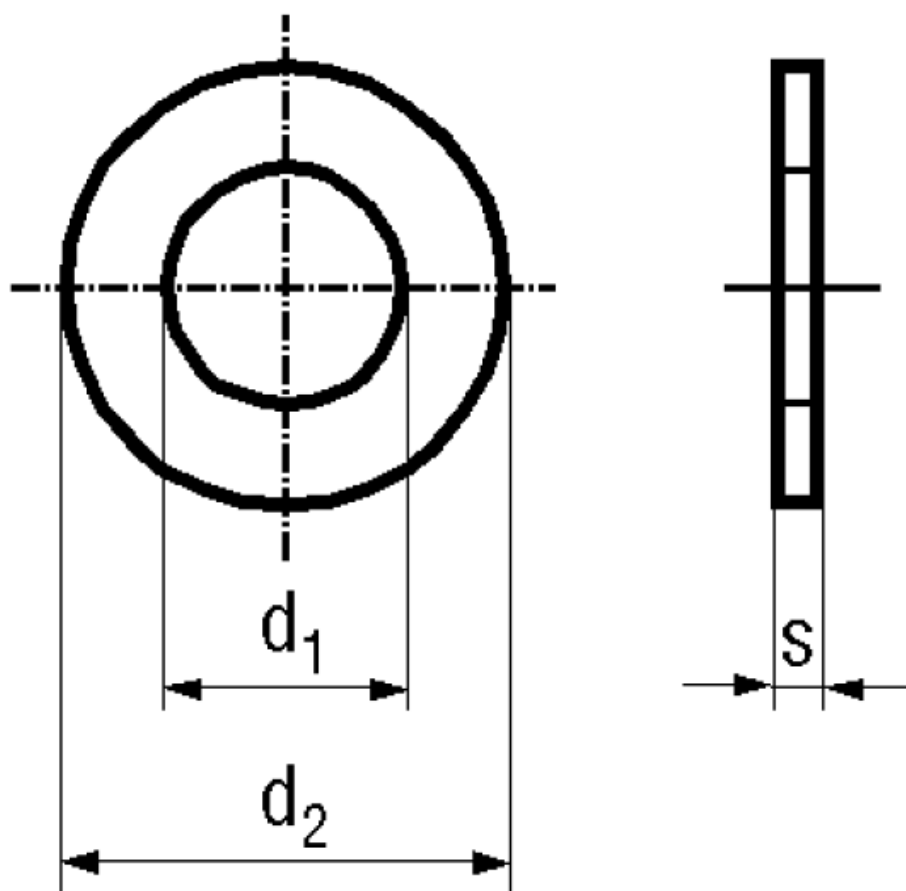

Material	Steel	Hardness grade	140 HV
Surface	zinc plated blue		

Article No. - 1887505	
for thread	M4
d_1	4,3
d_2	9
s	0,8

M4,5: Not included in DIN 125 A, ISO 7089 and VSM 13904
M1,7; M2,3; M2,6; M7; M18; M22; M27: Not included in ISO 7089