

BN 4879

Finishing washers
for 90° countersunk head screws

SN 213912

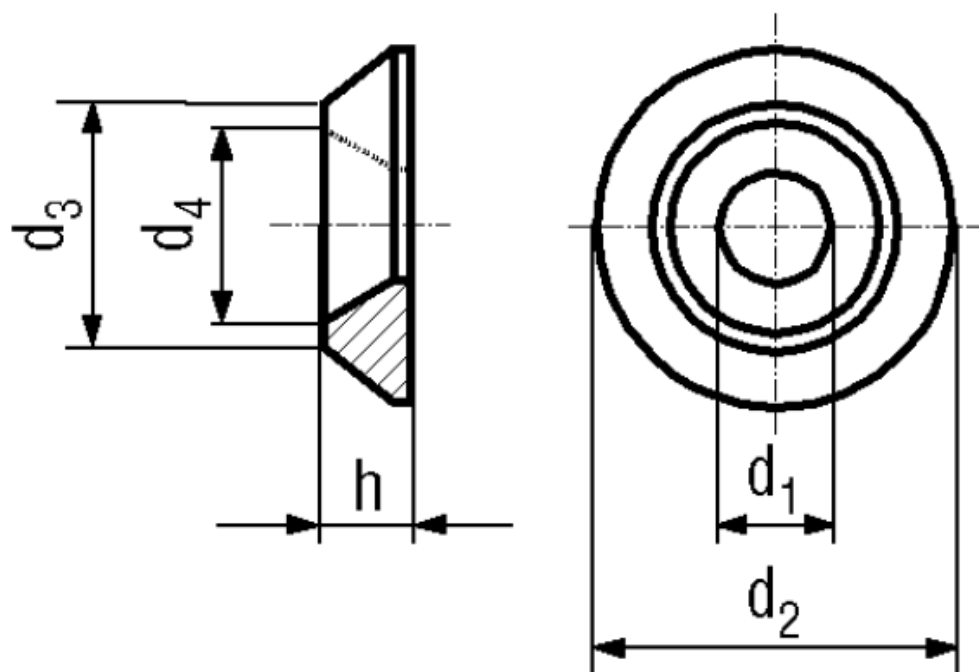

Material	Stainless steel	Quality	A1
----------	-----------------	---------	----

Article No. - 1184164

fit for	M4
d ₁ min.	4,3
d ₂ max.	14
d ₃	9,5
d ₄ min.	8,6
h min.	2,3