

BN 622

Hexagon head screws
fully threaded

DIN 933
ISO 4017
~UNI 5739

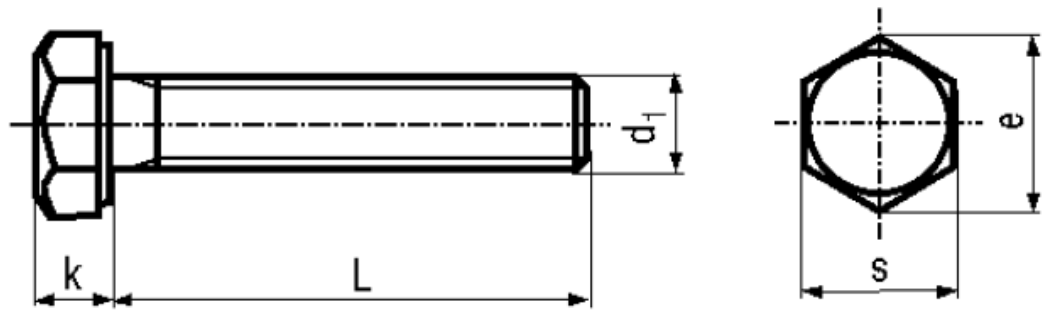

Material	Stainless steel	Quality	A2
----------	-----------------	---------	----

Article No. - 1237810

d ₁	M4
L	8
e	7,66
k	2,8
s	7

DIN 933: Standard withdrawn

Hex cap locking screws eco-fix®: BN 5951

WAF's according to ISO on request.

The current property class on the market is class 70 in A2-70 / A4-70 (tensile strenght 700 N/mm²).