

BN 54

Hexagon head screws
fully threaded

DIN 933
ISO 4017
~UNI 5739

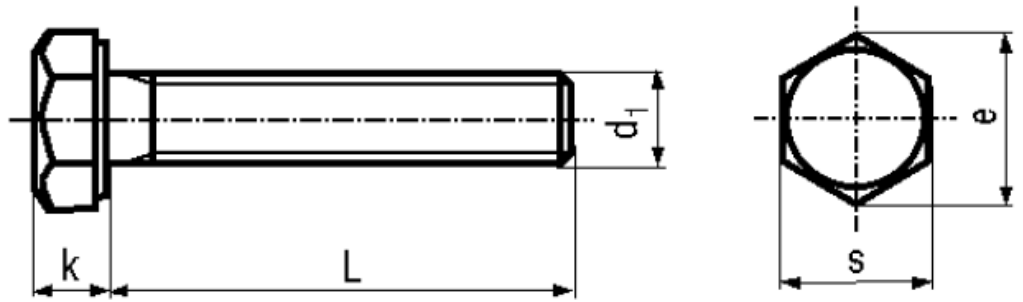

Material	Steel	Quality	8.8
Surface	black		

Article No. - 1042246

d ₁	M4
L	6
e	7,66
k	2,8
s	7

DIN 933: standard withdrawn

M10, M12, M14, M22: wrench size according to ISO on request