

BN 504 - DIN 934 - ~ISO 4032

Hexagon nuts ~0,8d

DIN 934
~ISO 4032
~UNI 5588

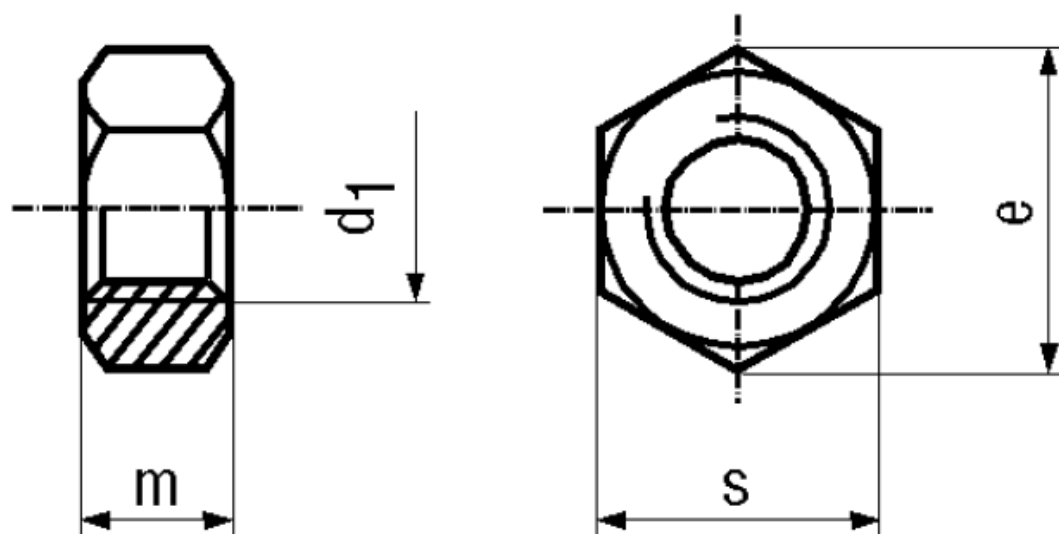

Material Surface

Article No. - 1195069

d_1	M2
e min.	4,32
s	4
m max.	1,6

DIN 934: Standard withdrawn
Wrench size according to ISO on request.