

BN 654

Slotted flat countersunk head screws

DIN 963 A
~ISO 2009
~UNI 6109

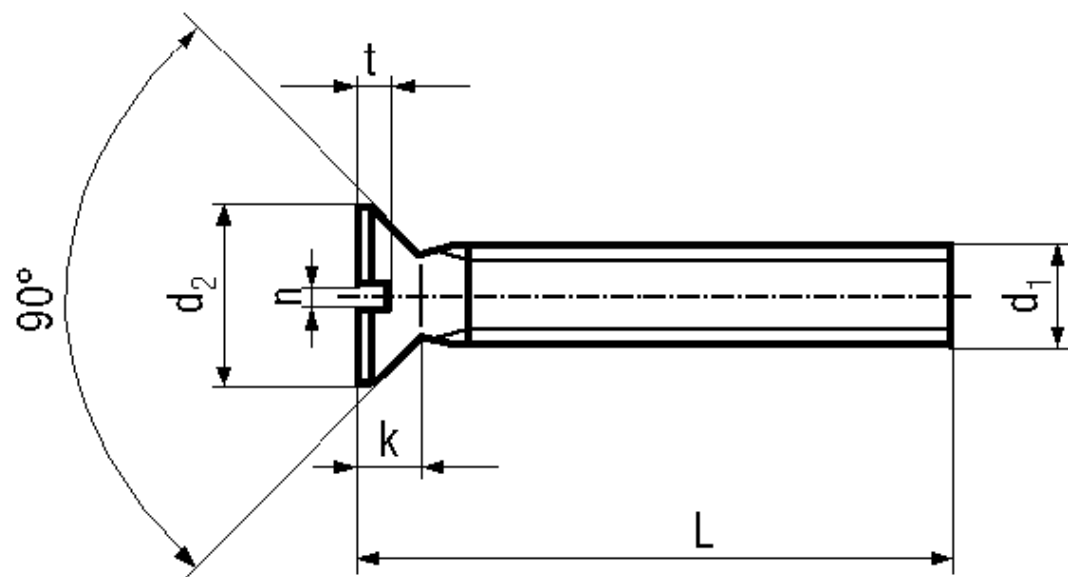

Material	Stainless steel	Quality	A2
----------	-----------------	---------	----

Article No. - 1075357

d ₁	M2
L	8
d ₂	3,8
k max.	1,2
n	0,5
t min.	0,4

DIN 963: Standard withdrawn

All lengths fully threaded.

Slotted flat countersunk head screws with small head VSM 13328: BN 658