

BN 654

Slotted flat countersunk head screws

DIN 963 A
~ISO 2009
~UNI 6109

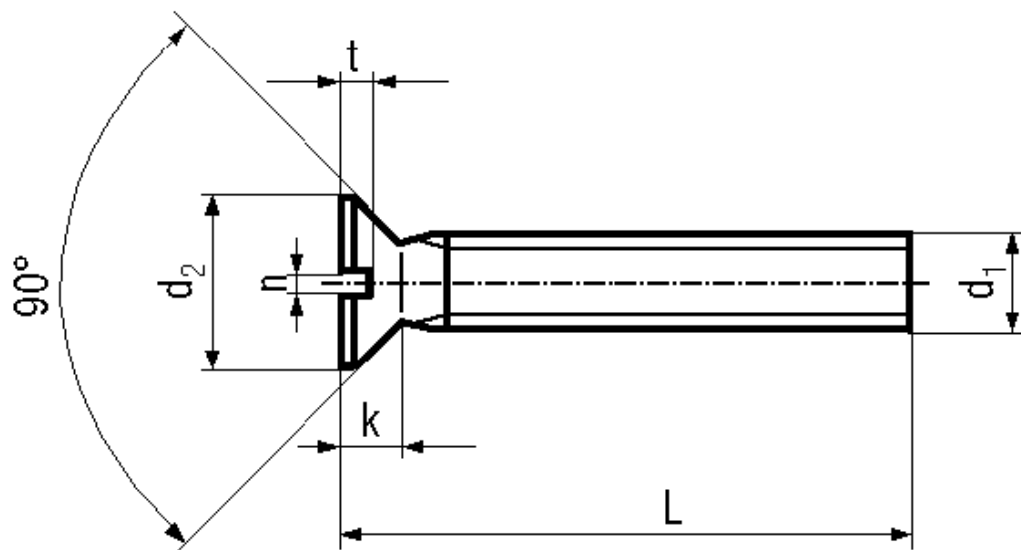

Material Quality

Article No. - 1427784	
d_1	M2
L	3
d_2	3,8
k max.	1,2
n	0,5
t min.	0,4

DIN 963: Standard withdrawn

All lengths fully threaded.

Slotted flat countersunk head screws with small head VSM 13328: BN 658