

BN 99

Rod ends
with integral spherical plain bearing
High type, right hand thread

ISO 12240-4 K

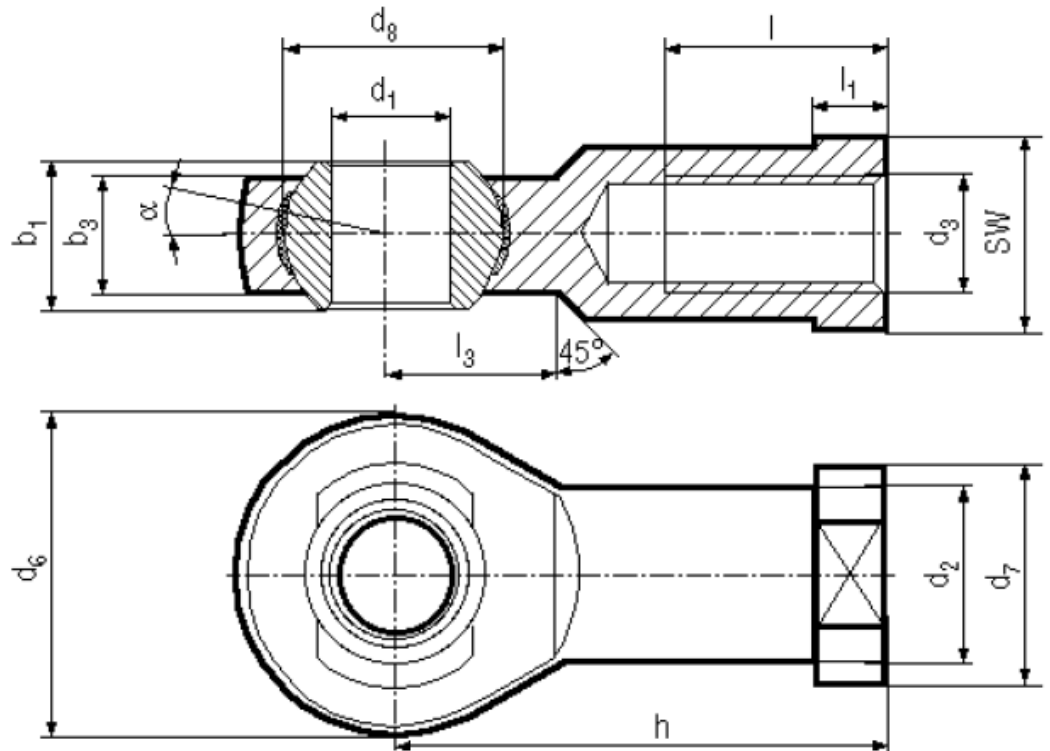

Trade mark	Durbal	Material	Steel
Type	BEF	Surface	zinc plated blue

Article No. - 1066579

d ₁	25
d ₂	33,5
d ₃	M24x2
d ₆	60
d ₇	42
d ₈	42,8
b ₁	31
b ₃	22
h	94
l	42
l ₁	12
l ₃	30
v	10
SW	36

The rod end ball slides on a bearing shell consisting of a glass fibre-filled nylon/teflon compound.
This design is maintenance-free.