

BN 748 - ~DIN 988

Shim washers

~DIN 988

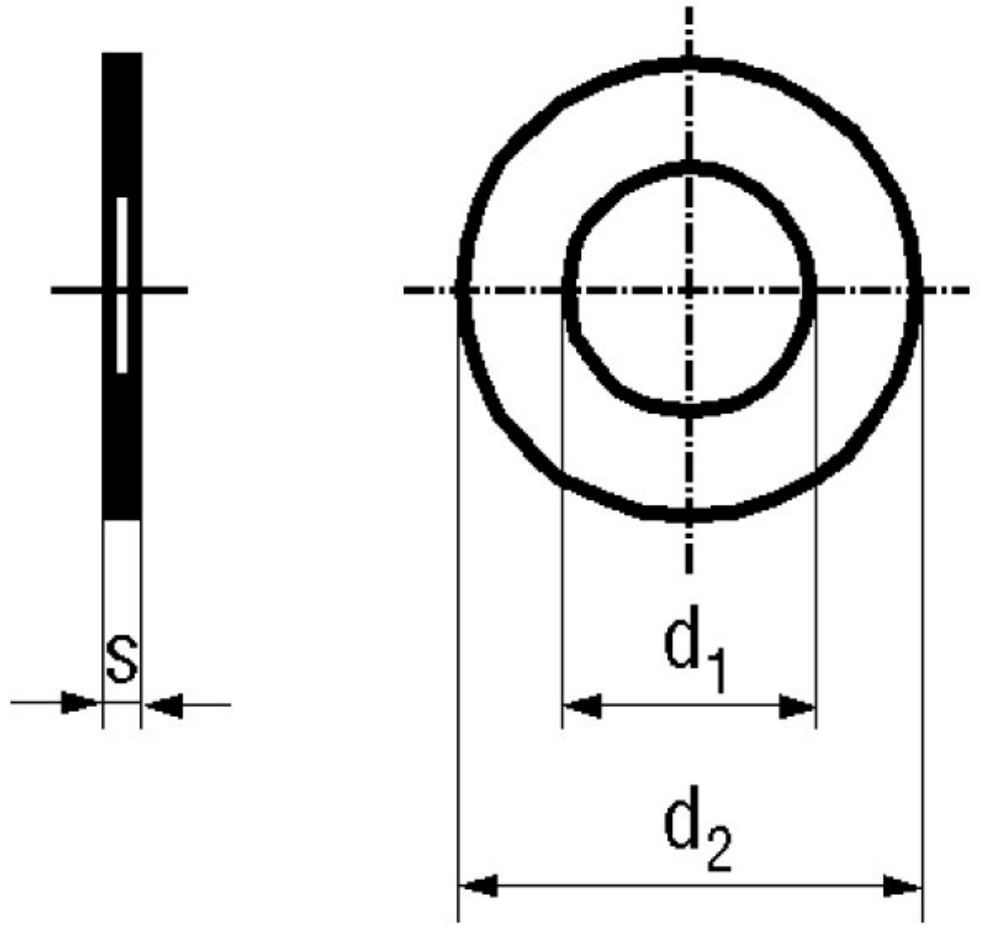

Material	Spring steel	Hardness grade	34-47 HRC
Surface	plain		

Article No. - 1272853	
d ₁	14
d ₂	26
s	0,1