

FIBRE WASHER

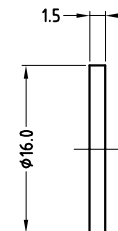

NUT OPTIONS

PLASTIC NUT

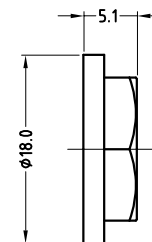

METAL NUT

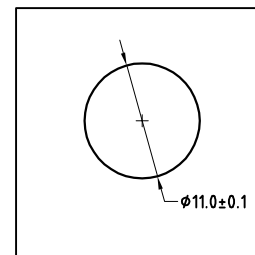
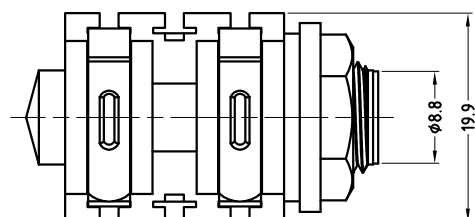
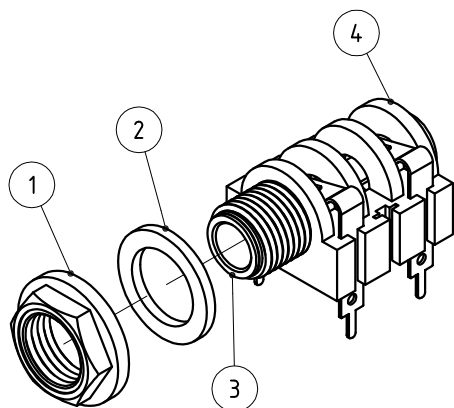
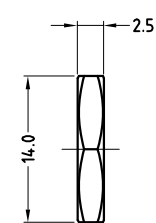

PANEL CUTOUT

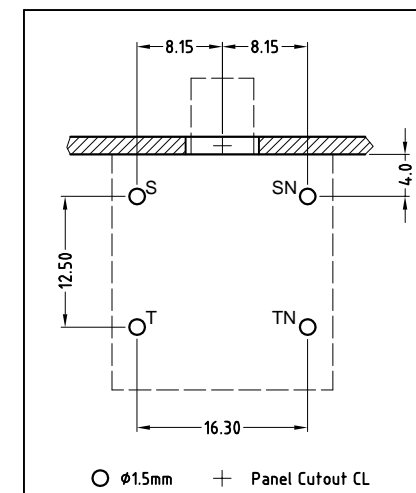

PCB LAYOUT

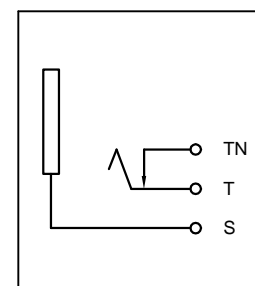

SCHEMATIC

ITEM	DESCRIPTION
1	METAL/PLASTIC NUT
2	FIBRE WASHER
3	METAL TUBE INSERT
4	CONNECTOR ASSEMBLY

PART No.	CATALOG No.	DESCRIPTION
55010096-000	ACJM-MC	METAL NUT
55010096-001	ACJM-PC	PLASTIC NUT

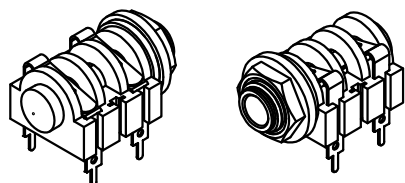

ISO VIEW

UNLESS OTHERWISE SPECIFIED TOLERANCE TO BE		THIS DOCUMENT IS THE PROPERTY OF AMPHENOL AUSTRALIA PTY. LTD.. NO PART THEREOF MAY BE REPRODUCED AND USED WITHOUT THE PRIOR WRITTEN CONSENT OF THE OWNER			
LINEAR	ANGULAR	CAD FILE:	DRN:	DATE:	REV.
X ± 0.5	X° ± 1°	55010096000111	L.V	17-10-01	0
X.X ± 0.1	X°X' ± 30'	MATL: REFER TO COMPONENT	CKD:	DATE:	1
X.XX ± 0.05	X°X'X" ± 15'	FINISH: REFER TO COMPONENT	M.N.H	13-01-06	CHANGE DETAILS
DO NOT SCALE		APP'D:	P.M	DATE:	BY
DIMENSIONS IN MILLIMETRES		SCALE:	2:1 UOS	DATE:	DATE
		THIRD ANGLE PROJECTION		DATE:	CHG/No

1	CHANGE DRAWING NUMBER & PART VARIATION NUMBER	L.V	07-07-04	8293
0	FIRST ISSUE	L.V	17-10-01	----
TITLE: 1/4" MONO JACK PCB & SODLER LUG CUSTOMER DRAWING				
DRAWING NO. 55010096-000-1			SHEET 1 OF 1	

Amphenol
Amphenol Australia Pty Ltd, 2 Fineways Blvd, Keysborough, Vic 3173