

Profil LARKO

Nr ref A05552

Ref. arch B5552

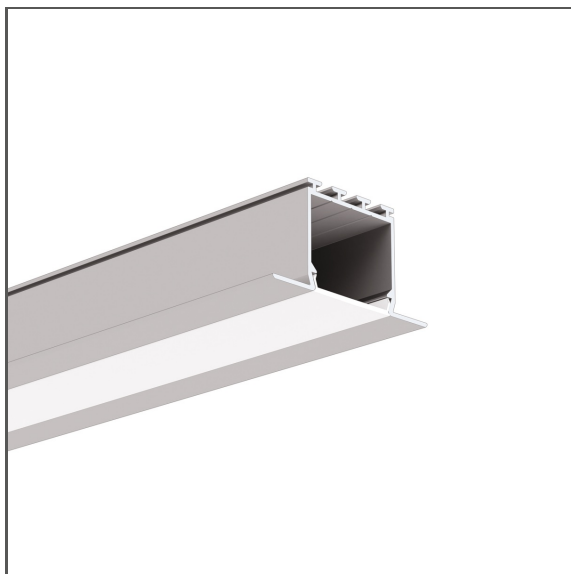

- Montaż do płyt gipsowo-kartonowych
- Niewidoczna krawędź wpustu
- Możliwość montażu zasilacza w części świecącej oprawy

PRZEZNACZENIE PRODUKTU

- oświetlenie główne i dekoracyjne

MONTAŻ

- we wpustach, za pomocą dedykowanych akcesoriów
- możliwość łatwego łączenia w ciągi i systemy

INFORMACJE DODATKOWE

- standardowe długości profili oraz osłon KLUŚ: 1000 mm (tolerancja $\pm 1,5$ mm) oraz 2005 mm / 3010 mm (tolerancja +5 mm); dla wybranych osłon 6050 mm, 10050 mm (tolerancja +5 mm)
- wybierając inną długość profili / osłon niż dostępna w standardzie należy dodatkowo wybrać usługę cięcia w firmie KLUŚ

RYSUNEK TECHNICZNY

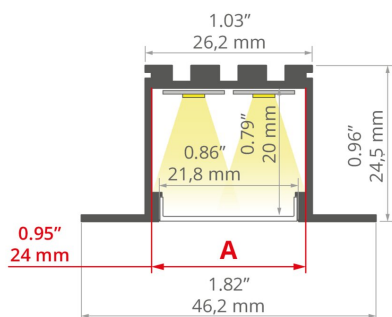

SPECYFIKACJA TECHNICZNA



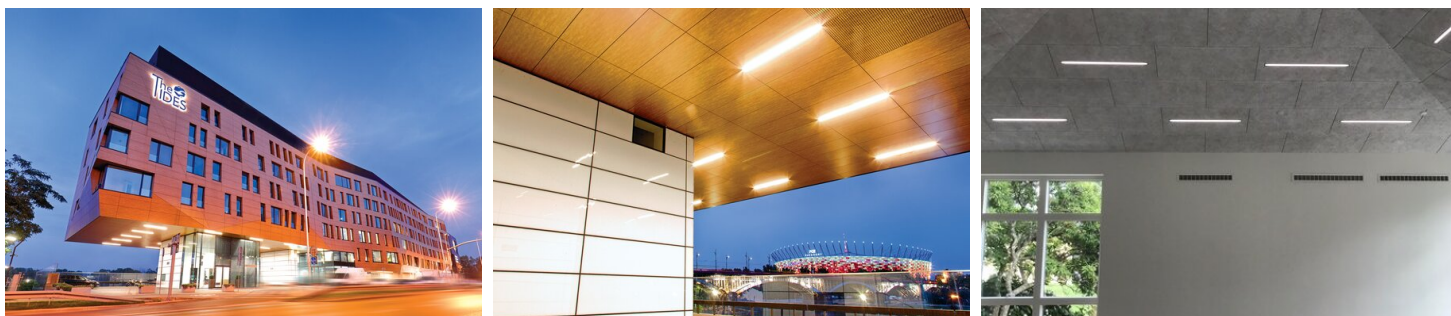

Materiał	aluminium
Możliwe IP oprawy	20, 65
Możliwe kształty oprawy	liniowy, wielokątny
Przekrój profilu	prostokątny
Szerokość	46,2 mm
Wysokość	24,5 mm
Szerokość klejenia LED A	24 mm
Liczba pasków LED A (szerokość 8 mm)	2
Max moc pojedynczej taśmy LED KLUŚ	24 W/m
Z możliwością uzyskania linii światła	tak
Typ budynku	Obiekt komercyjny, Obiekt kulturalny/rozrywkowy, Obiekt horeca
Przestrzeń	biuro, ciągi komunikacyjne, sala konferencyjna, lobby / foyer
Osłona docinana jest na długość profilu	tak
Możliwość łatwego łączenia w ciągi	tak
Do płyt gipsowo-kartonowych	tak
Wyprowadzenie przewodu od spodu	tak

Kolor	Długość	Ref
■ srebrny anodowany	1000 mm	A05552A_1 B5552ANODA_1
	2005 mm	A05552A_2 B5552ANODA_2
	3010 mm	A05552A_3 B5552ANODA_3
□ biały lakierowany	2005 mm	A05552L10OD_2 B5552L9010OD_2
	1000 mm	A05552L10OD_1 B5552L9010OD_1
	3010 mm	A05552L10OD_3 B5552L9010OD_3

PRZYKŁADOWE REALIZACJE



POWIĄZANE AKCESORIA > OSŁONY

NAZWA	MATERIAŁ	PRZEPUSZCZALNOŚĆ	KOLOR	NR REF	
LIGER		PC	62 %	satyna	B17032S 17032V1
			39 %	czarna	B17032B 17087
HS		PC	73 %	mleczny	B17011F 17011
			94 %	przezroczysty	B17011C 17022
G		PMMA	69 %	satyna	B17006S 17010
			85 %	półprzezroczysta	B17006T 17017
			95 %	przezroczysty	B17006C 17006
			30 %	czarna	B17006B 17012
MUN-22		PC	86 %	mrożony	B17042F 17042

POWIĄZANE AKCESORIA > ZAŚLEPKI

NAZWA	MATERIAŁ	KOLOR	NR REF
LARKO		<input checked="" type="checkbox"/> szary	C24006C02 24006
		<input checked="" type="checkbox"/> srebrny	C24006L01 24102
		<input type="checkbox"/> biały	C24006C10 24410

POWIĄZANE AKCESORIA > LED

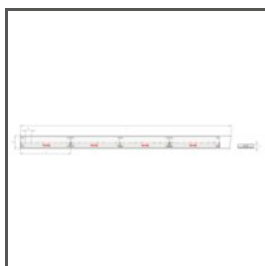

WP-K-30/18-1770-010V-24V
WP-K-30/18-1770-010V-24V
Ref. arch WP-K-30/18-1770-010V-24V

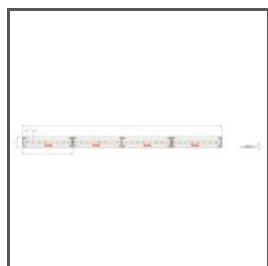

K-30/18-1770-010V-24V
K-30/18-1770-010V-24V
Ref. arch K-30/18-1770-010V-24V

POWIĄZANE AKCESORIA > LED > BIAŁE MONO



K-1220-24V
K-1220-24
Ref. arch K-1220-24V

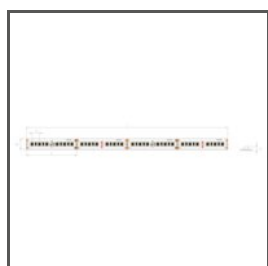

K-1275-24V
K-1275-24
Ref. arch K-1275-24V

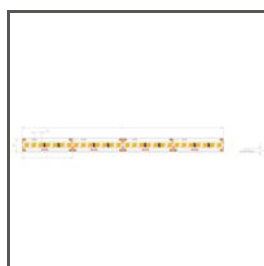

K-1910-HD-24V
K-HD-1910-24
Ref. arch K-1910-HD-24V

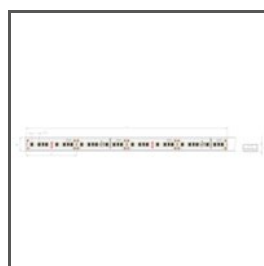

WP-K-1220-24V
KWP-1220-24
Ref. arch WP-K-1220-24V



WP-K-1275-24V
KWP-1275-24
Ref. arch WP-K-1275-24V



WP-K-1910-HD-IP65-24V
KWP-GHD-1910-24
Ref. arch WP-K-1910HDIP6524V



WP-K-1220-IP65-24V
KWP-1220-IP65-24
Ref. arch WP-K-1220-IP65-24V



K-0530-HD-24V
K-HD-0530-24
Ref. arch K-0530-HD-24V

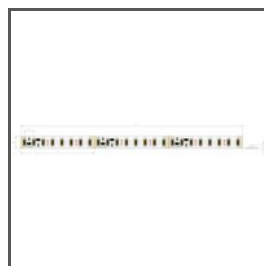

K-2300-24V
K-2300-24
Ref. arch K-2300-24V

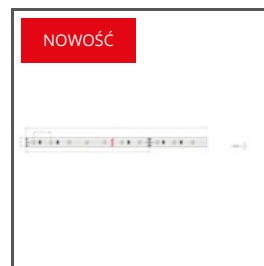

K-0480-24V
K-0480-24
Ref. arch K-0480-24V

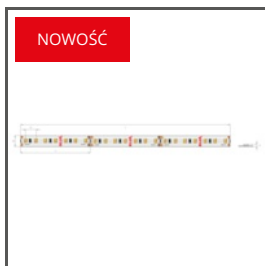

K-0960-24V
K-0960-24
Ref. arch K-0960-24V



K-1440-24V
K-1440-24
Ref. arch K-1440-24V



K-2400-24V
K-2400-24



K2-1920-24V
K2-1920-24

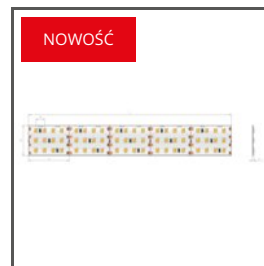

K3-2880-24V
K3-2880-24

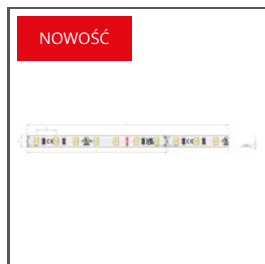

K-CR-0480-24V
K-CR-0480-24



K-CR-0960-24V
K-CR-0960-24



K-CR-1440-24V
K-CR-1440-24

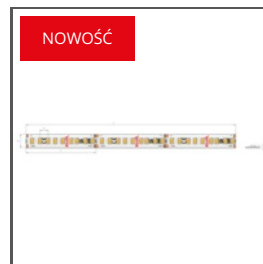

K-VHE-0480-24V
K-VHE-0480-24

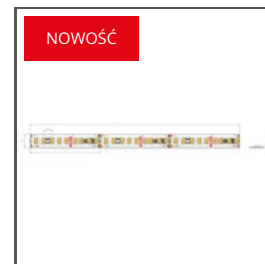

K-VHE-0960-24V
K-VHE-0960-24

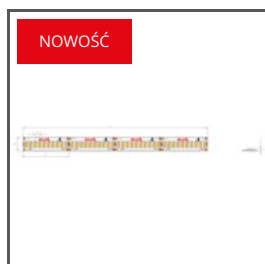

K-VHE-1440-24V
K-VHE-1440-24

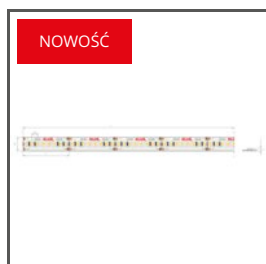

K-HD-0480-24V
K-HD-0480-24

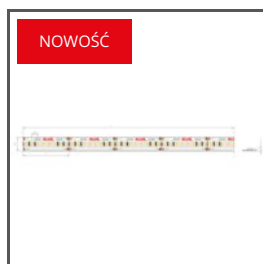

K-HD-0960-24V
K-HD-0960-24

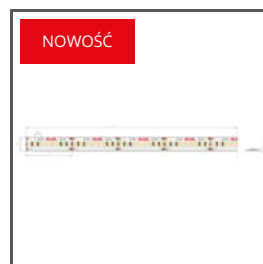

K-HD-1440-24V
K-HD-1440-24



WP-K-1910-HD-24V
KWP-HD-1910-24
Ref. arch WP-K-1910-HD-24V



WP-K-1440-24V
KWP-1440-24
Ref. arch WP-K-1440-24V



WP-K-0480-24V
KWP-0480-24
Ref. arch WP-K-0480-24V

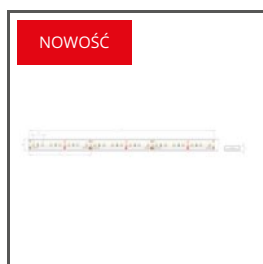

WP-K-0960-24V
KWP-0960-24
Ref. arch WP-K-0960-24V



KWP-GHD-0480-24V
KWP-GHD-0480-24



KWP-CR-0480-24
KWP-CR-0480-24



KWP-CR-0960-24
KWP-CR-0960-24

POWIĄZANE AKCESORIA > LED > CRI 95+

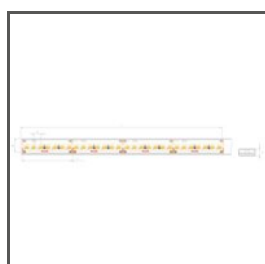

WP-K-CR-1820-HD-24V
WPKCR1820HD24
Ref. arch WPKCR1820HD24V



WP-K-CR-1910-HD-24V
KWP-CRHD-1910-24
Ref. arch WPK-CR-1910-HD-24V

POWIĄZANE AKCESORIA > LED > RGB / RGB-W / RGB-CTT



K-1275-RGB-24V
K-RGB-1275-24
Ref. arch K-1275-RGB-24V

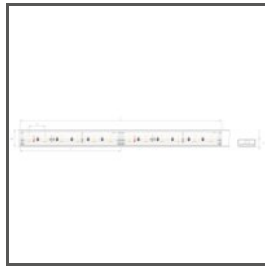

WP-K-1275-RGB-24V
KWP-RGB-1275-24
Ref. arch WP-K-1275-RGB-24V

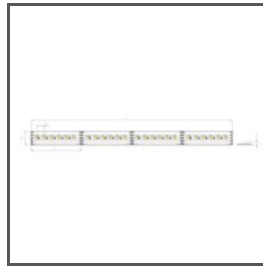

K-1530-RGB+W-24V
K-RGBW-1530-24
Ref. arch K-1530-RGB+W-24V



WP-K-1530-RGB+W-24V
KWP-RGBW-1530-24
Ref. arch WP-K-1530-RGB+W-24V

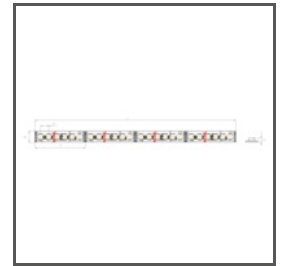

K-1920-120-RGB-24V
K-RGB-1920-120-24
Ref. arch K-1920-120-RGB-24V



WP-K-1920-120-RGB-24V
KWP-1920-120-RGB-24
Ref. arch WP-K-1920-120-RGB-24V

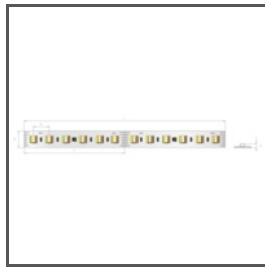

K-1200-RGB+27/65-24V
K-RGB27/65-1200-24
Ref. arch K-1200-RGB+27/65-24V



K-RGB-1200-24V
K-RGB-1200-24
Ref. arch K-RGB-1200-24V

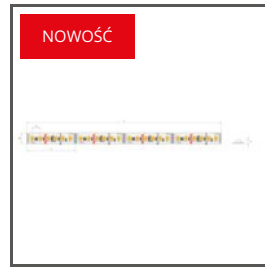

K-RGB-0700-24V
K-RGB-0700-24
Ref. arch K-RGB-0700-24V



WP-K-1200-RGB+27/65-24V
WPK-RGB27/65-1200-24
Ref. arch WP-K-1200-RGB+27/65-24V



WP-K-1530-RGB+W-IP65-24V
KWP-GRGBW-1530-24
Ref. arch WP-K-1530RGBWIP6524V

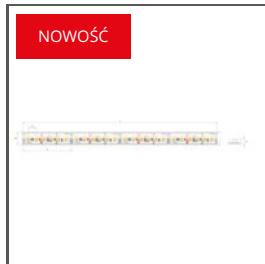

WP-K-RGB-0700-24V
KWP-RGB-0700-24
Ref. arch WP-K-RGB-0700-24V



WP-K-RGB-1200-24V
KWP-RGB-1200-24
Ref. arch WP-K-RGB-1200-24V

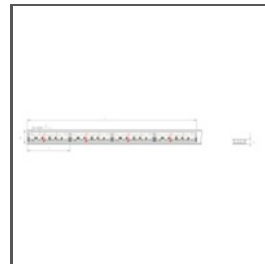

14K-WP-K-1920-120-RGB-24V
KWP-14KHDRGB-1920-24
Ref. arch 14KWPK1920120RGB24V

POWIĄZANE AKCESORIA > LED > REGULACJA TEMPERATURY BARWOWEJ



K-27/50-1440-24V
K-27/50-1440-24



KWP-27/50-1440-24
KWP-27/50-1440-24

POWIĄZANE AKCESORIA > LED > WYSOKA SKUTECZNOŚĆ ŚWIETLNA

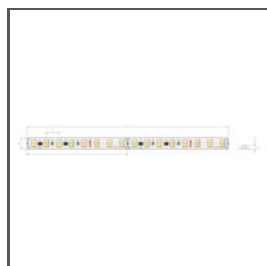

K-HE-0480-HD-24V
K-HEHD-0480-24
Ref. arch K-HE-0480-HD-24V

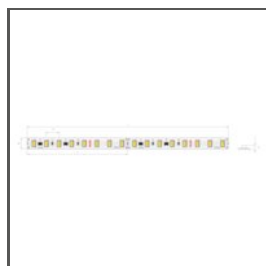

K-HE-0960-HD-24V
K-HEHD-0960-24
Ref. arch K-HE-0960-HD-24V

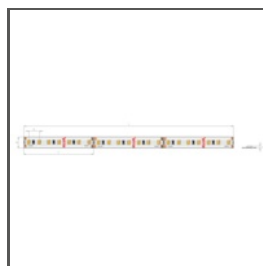

K-HE-1440-HD-24V
K-HEHD-1440-24
Ref. arch K-HE-1440-HD-24V

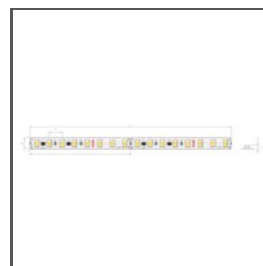

K-HE-1920-HD-24V
K-HEHD-1920-24
Ref. arch K-HE-1920-HD-24V

POWIĄZANE AKCESORIA > LED > ŚWIECENIE W BOK

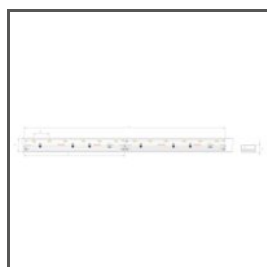

WP-K-SE-1210-8-24V
KWP-SE-1210-24-8
Ref. arch WP-K-SE-1210-8-24V

POWIĄZANE AKCESORIA > INNE AKCESORIA > KSZTAŁTKI

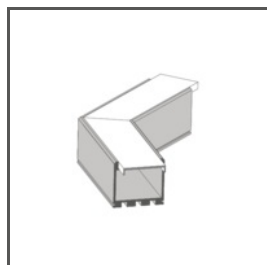

KSZTAŁTKA
L135
L135

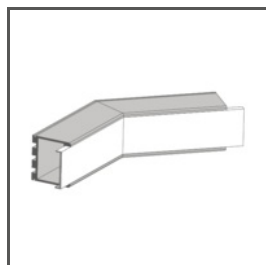

KSZTAŁTKA
L135PW
L135PW

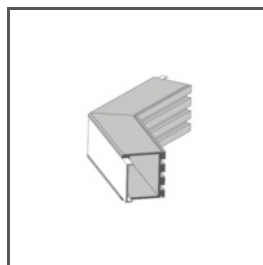

KSZTAŁTKA
L135PZ
L135PZ

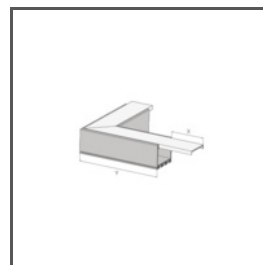

KSZTAŁTKA
L90
L90

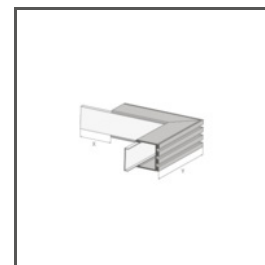

KSZTAŁTKA
L90PW
L90PW

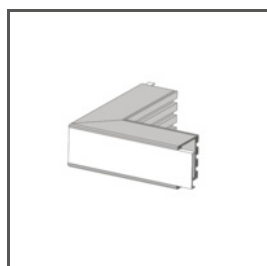

KSZTAŁTKA
L90PZ
L90PZ

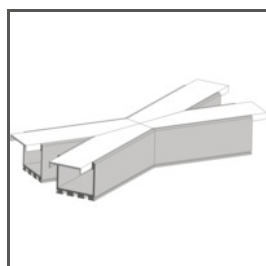

KSZTAŁTKA
X135
X135

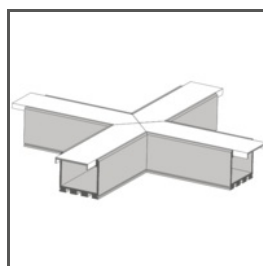

KSZTAŁTKA
X90
X90

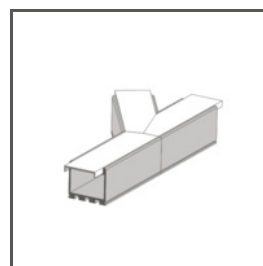

KSZTAŁTKA
T135L
T135L

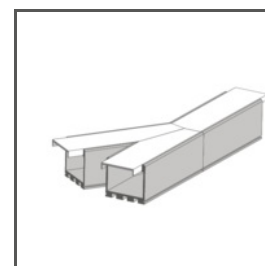

KSZTAŁTKA
T135R
T135R

Profil LARKO

Nr ref A05552

Ref. arch B5552

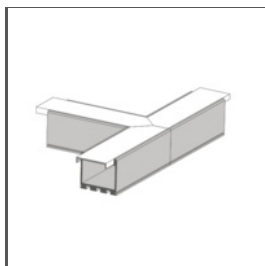

KSZTAŁTKA

T90

T90

POWIĄZANE AKCESORIA > INNE AKCESORIA > MASKOWNICE DO PROFILI



MASKOWNICA

MP-22

C28261L01_0.25,
C28261L10_0.25,
C28261L07_0.25

Ref. arch 17167, 17167L9010,
17167L9005

POWIĄZANE AKCESORIA > INNE AKCESORIA > POZOSTAŁE



DŁAWNICA

6,4x3

C42264C07

Ref. arch 42264

POWIĄZANE AKCESORIA > INNE AKCESORIA > SPRĘŻYNY DO WPUSTÓW I PROFILI TECHNICZNYCH

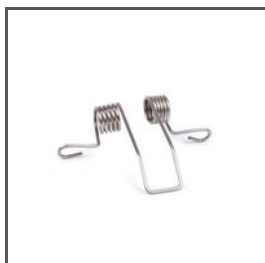

SPRĘŻYNA

KMA

C24503N00

Ref. arch 00838

POWIĄZANE AKCESORIA > INNE AKCESORIA > ZATRZASKI



ZATRZASK

TEKNIK

C24003C10

Ref. arch 24003

POWIĄZANE AKCESORIA > INNE AKCESORIA > ZAWIESZKI I GŁOWICE DO PROFILI PRZEWODNIKOWE



ZAWIESZKA

OS22-LIN-Z

C28184L07, C28184L10

Ref. arch 42341L9005, 42341L9010



ZAWIESZKA

OS22-PRET-Z

C28186L07, C28186L10

Ref. arch 42344L9005, 42344L9010



ZAWIESZKA

OS22-DUO-LIN-Z

C28183L07, C28183L10

Ref. arch 42340L9005, 42340L9010



ZAWIESZKA

OS22-DUO-PRET-Z

C28185L07, 42343L9010

Ref. arch 42343L9005, 42343L9010

POWIĄZANE AKCESORIA > INNE AKCESORIA > ŁĄCZNIKI



ŁĄCZNIK

ZM-180

C28075N00

Ref. arch 40693



ŁĄCZNIK

ZM-NA-60

42305



ŁĄCZNIK

ZM-NA-PION-120

42321



ŁĄCZNIK

ZM-NA-90

42723



ŁĄCZNIK

ZM-NA-PION-135

42727