

"Schutzvermerk nach DIN ISO 16016 beachten." "Please pay attention to copyright note DIN ISO 16016"

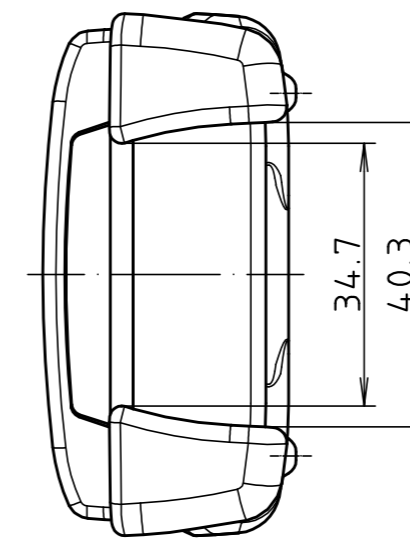

BS 400 mit DI-D
parallel montiert
BS 400 with Di-D
parallel assembled

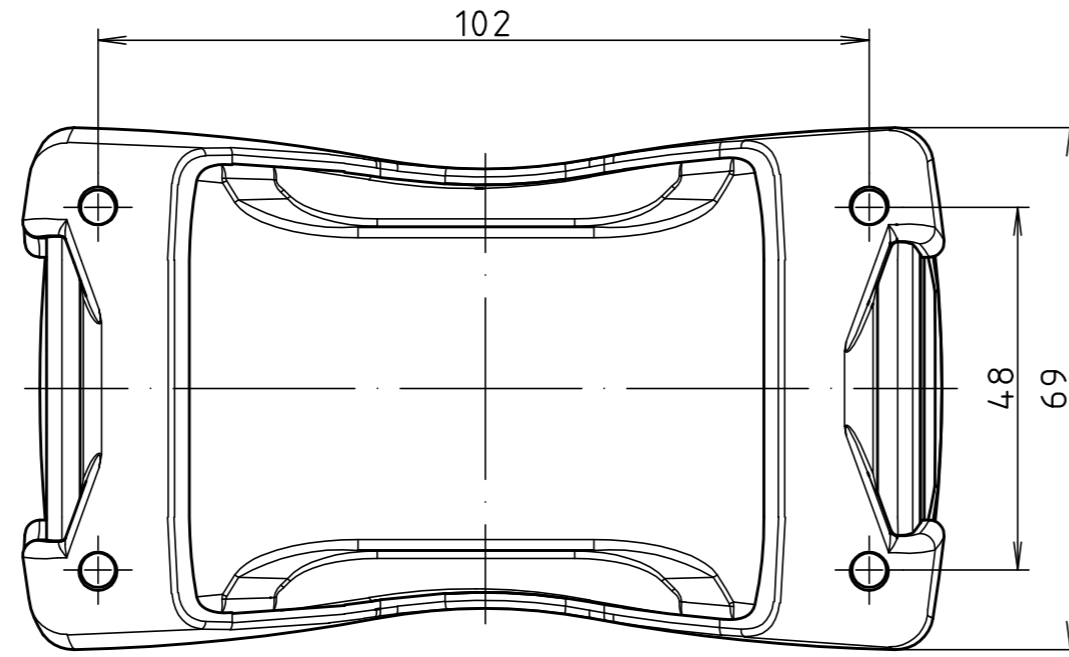
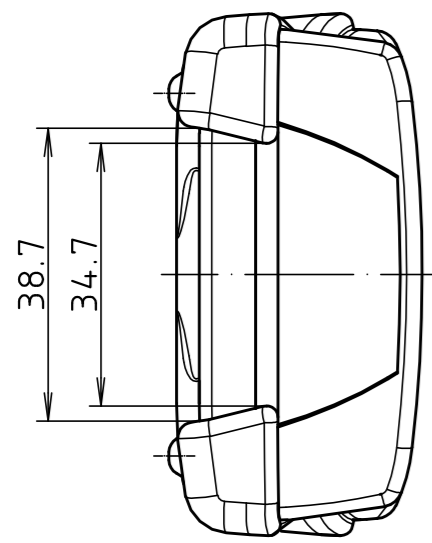
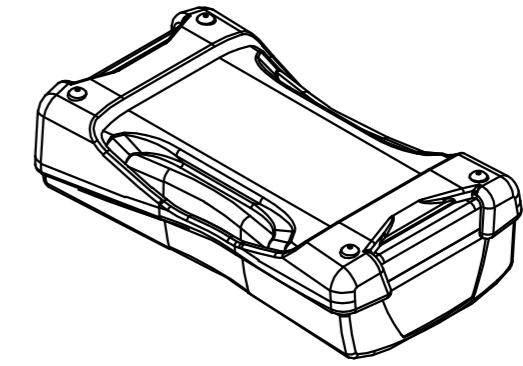

BS 400 mit DI-D
pultförmig montiert
BS 400 with Di-D
inclined assembled

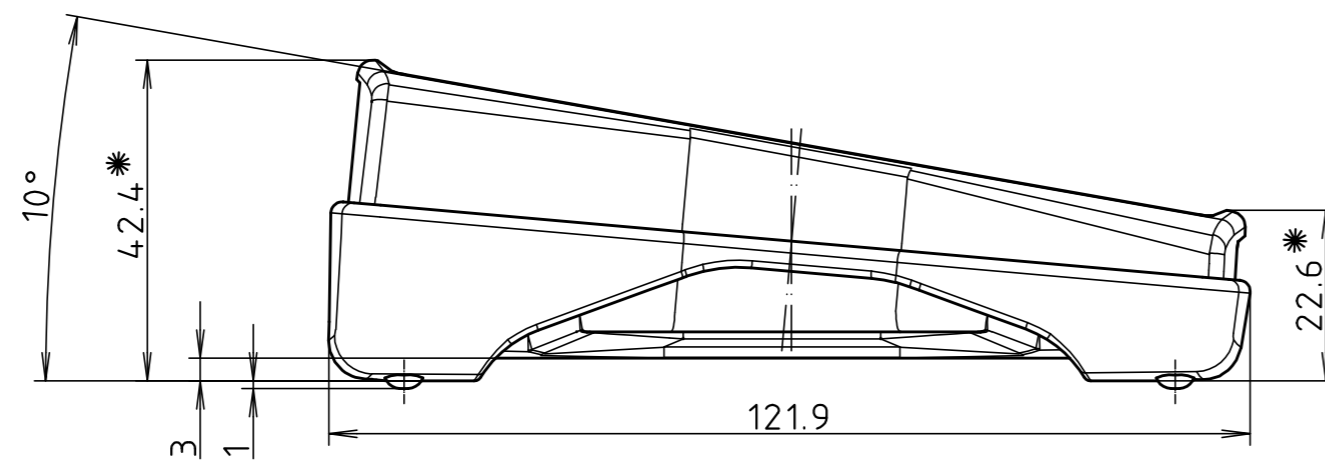
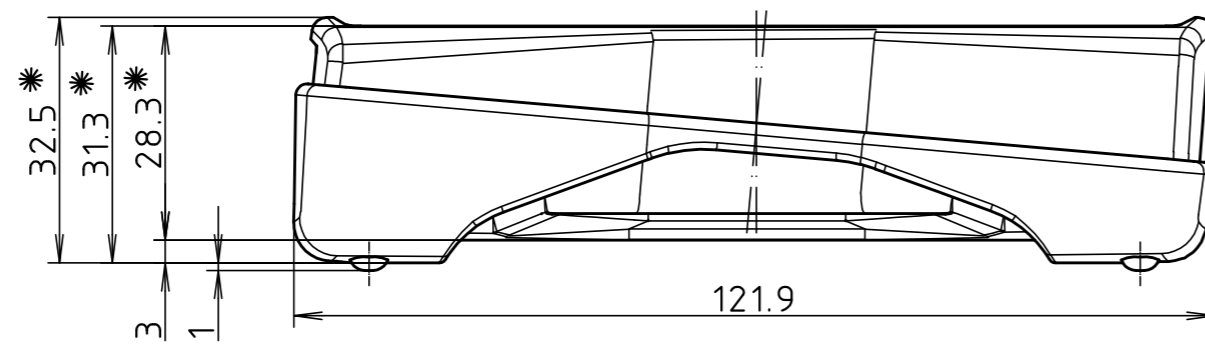
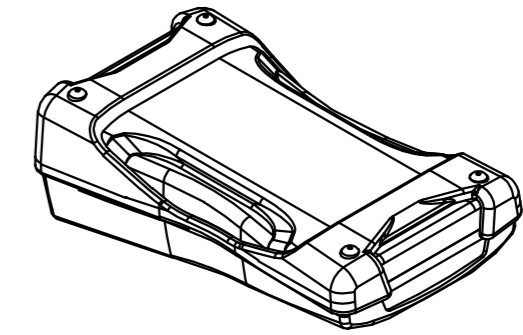

BS 400 DI-D

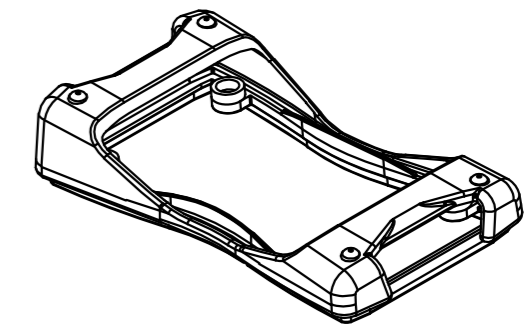
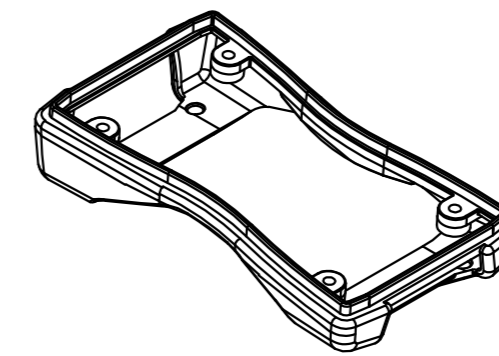

* Je nach Anzugsmoment verringern sich die Maße um bis zu 0.5mm.
The dimensions reduce up to 0.5mm depend by the torque

Maßstab/ Scale:	1:1	
Zeichnungs-Nr. / Drawing-No.: 2K 5355.040.01		
Artikel / Article: BS 400 DI-D Katalogzeichnung/ Catalogue drawing		
A.Nr./ Alt-No.:	Datum/ Date:	
DISK: 2 802 691		
Datum/Date: 09.06.06 KH		

