

FEATURES

- **Isolation Test Voltage: 5300 V_{RMS}**
- **TTL Compatible**
- **High Bit Rates: 1.0 Mbit/s**
- **High Common-Mode Interference Immunity**
- **Bandwidth 2.0 MHz**
- **Open-Collector Output**
- **External Base Wiring Possible**
- **Field-Effect Stable by TRIOS***
- **Underwriters Lab File #E52744**
- **VDE #0884 Approval Available with Option 1**

Description

The 6N135 and 6N136 are optocouplers with a GaAlAs infrared emitting diode, optically coupled with an integrated photodetector which consists of a photodiode and a high-speed transistor in a DIP-8 plastic package.

Signals can be transmitted between two electrically separated circuits up to frequencies of 2.0 MHz. The potential difference between the circuits to be coupled is not allowed to exceed the maximum permissible reference voltages.

Maximum Ratings
Emitter

Reverse Voltage 5.0 V
 Forward Current 25 mA
 Peak Forward Current
 (t = 1.0 ms, duty cycle 50%) 50 mA
 Maximum Surge Forward Current
 (t ≤ 1.0 μs, 300 pulses/s) 1.0 A
 Thermal Resistance 700 K/W
 Total Power Dissipation (T_A ≤ 70°C) 45 mW

Detector

Supply Voltage -0.5 to 15 V
 Output Voltage -0.5 to 15 V
 Emitter-Base Voltage 5.0 V
 Output Current 8.0 mA
 Maximum Output Current 16 mA
 Base Current 5.0 mA
 Thermal Resistance 300 K/W
 Total Power Dissipation (T_A ≤ 70°C) 100 mW

Package

Isolation Test Voltage (between emitter and detector climate per DIN 50014, part 2, Nov. 74 (t = 1.0 s) 5300 V_{RMS}
 Pollution Degree (DIN VDE 0109) 2.0
 Creepage ≥ 7.0 mm
 Clearance ≥ 7.0 mm
 Comparative Tracking Index per DIN IEC 112/VDE 0303 part 1, Group IIIa per DIN VDE 6110 175
 Isolation Resistance
 V_{IO} = 500 V, T_A = 25°C ≥ 10¹² Ω
 V_{IO} = 500 V, T_A = 100°C ≥ 10¹¹ Ω
 Storage Temperature Range -55°C to +125°C
 Ambient Temperature Range -55°C to +100°C
 Soldering Temperature (max. ≤ 10 s, dip soldering ≥ 0.5 mm from case bottom) 260°C

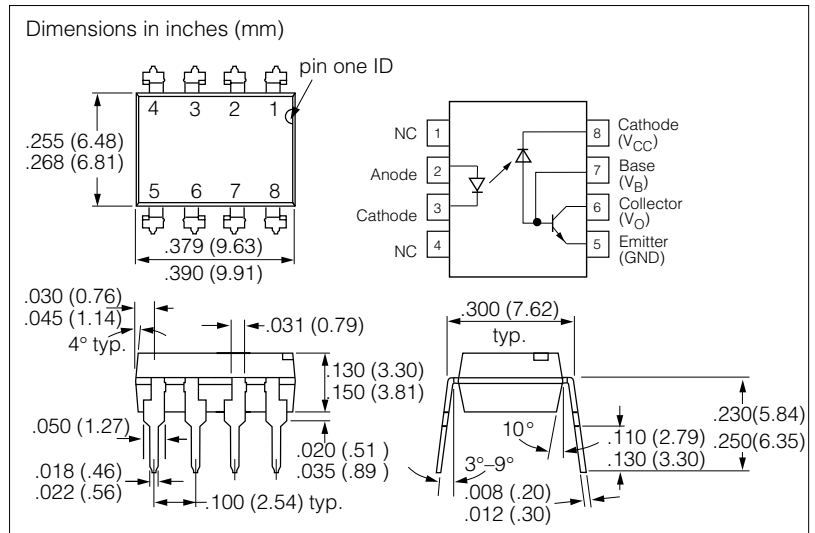
Characteristics T_A = 0 to 70°C unless otherwise specified, T_A = 25°C typ.

Emitter	Symbol	Value	Unit	Condition
Forward Voltage	V _F	1.6 (≤ 1.9)	V	I _F = 16 mA
Breakdown Voltage	V _{BR}	≥ 5.0		I _R = 10 μA
Reverse Current	I _R	0.5 (≤ 10)	μA	V _R = 5.0 V
Capacitance	C _O	125	pF	V _R = 0 V, f = 1.0 MHz
Temperature Coefficient, Forward Voltage	ΔV _F / ΔT _A	-1.7	mV/°C	I _F = 16 mA
Detector				
Supply Current Logic Low	I _{CCL}	150	μA	I _F = 16 mA, V _O open, V _{CC} = 15 V
Supply Current Logic High	I _{CCH}	0.01 (≤ 1)		I _F = 0 mA, V _O open, V _{CC} = 15 V
Output Voltage, Output Low	V _{OL}	0.1 (≤ 0.4)	V	I _F = 16 mA, V _{CC} = 4.5 V
Output Current, 6N135				I _O = 1.1 mA
Output Current, 6N136				I _O = 2.4 mA
Output Current, Output High	I _{OH}	3.0 (≤ 500)	nA	I _F = 0 mA, V _O = V _{CC} = 5.5 V
Output Current, Output High				0.01 (≤ 1)
Package				
Coupling Capacitance, Input-Output	C _{IO}	0.6	pF	f = 1.0 MHz
Current Transfer Ratio				
6N135	CTR	16 (≥ 7.0)	%	I _F = 16 mA, V _O = 0.4 V, V _{CC} = 4.5 V, T _A = 25°C
6N136	CTR	35 (≥ 19)		
6N135	CTR	≥ 5.0		I _F = 16 mA, V _O = 0.5 V, V _{CC} = 4.5 V
6N136	CTR	≥ 15		

***TRIOS—TR**ansparent **IO**n Shield

Figure 1. Switching Times

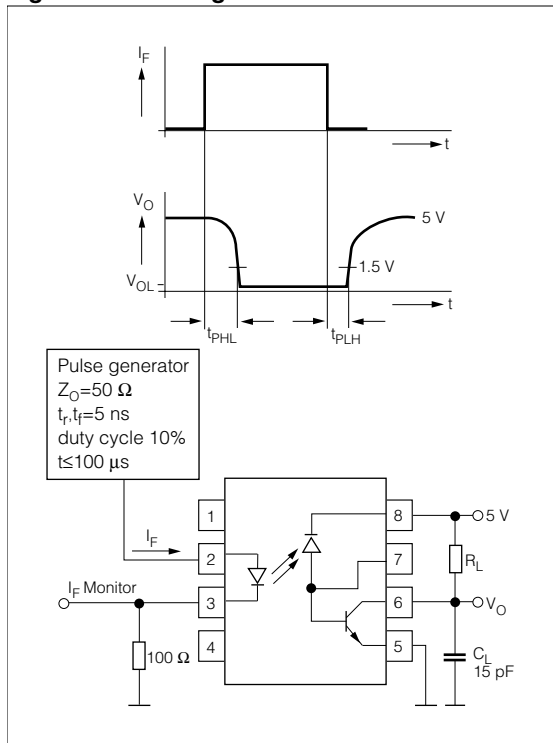
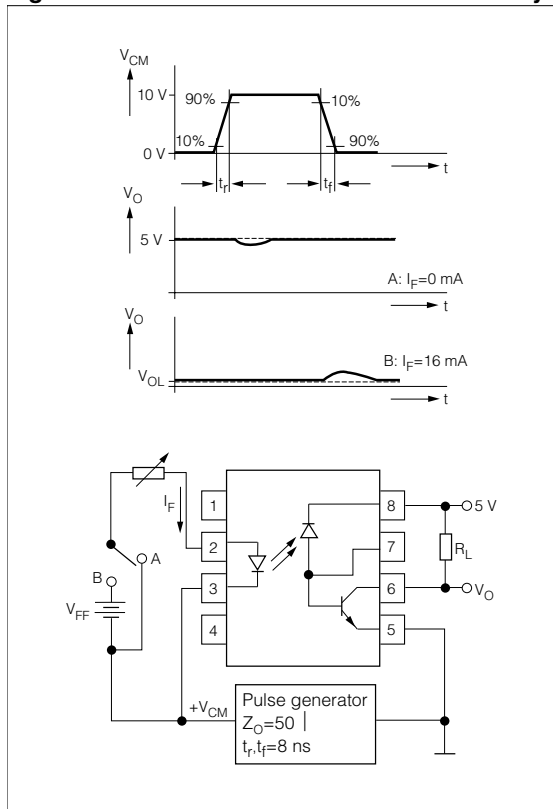

Figure 2. Common-mode Interference Immunity



Delay Time $I_F=16 \text{ mA}$, $V_{CC}=5.0 \text{ V}$, $T_A=25^\circ\text{C}$

Parameter	Symbol	Value	Unit	Condition	
High-Low	6N135	t_{PHL}	0.3 (≤ 1.5)	μs	$R_L=4.1 \text{ k}\Omega$
	6N136				$R_L=1.9 \text{ k}\Omega$
Low-High	6N135	t_{PLH}	0.3 (≤ 1.5)	μs	$R_L=4.1 \text{ k}\Omega$
	6N136				$R_L=1.9 \text{ k}\Omega$

Common Mode Interference Immunity

$V_{CM}=10 \text{ V}_{P-P}$, $V_{CC}=5.0 \text{ V}$, $T_A=25^\circ\text{C}$

Parameter	Symbol	Value	Unit	Condition	
High, $I_F=0 \text{ mA}$	6N135	CMH	1000	$\text{V}/\mu\text{s}$	$R_L=4.1 \text{ k}\Omega$
	6N136				$R_L=1.9 \text{ k}\Omega$
Low, $I_F=16 \text{ mA}$	6N135	CML			$R_L=4.1 \text{ k}\Omega$
	6N136				$R_L=1.9 \text{ k}\Omega$

Figure 3. LED forward current vs. forward voltage

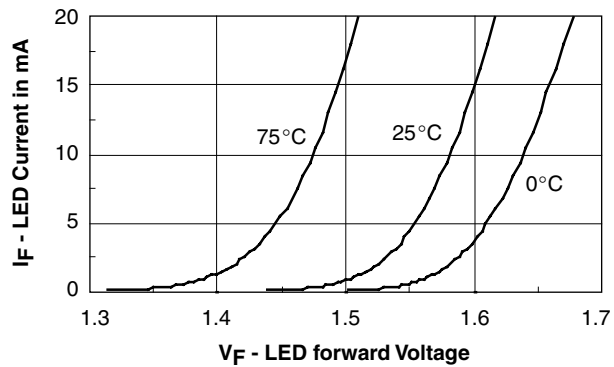

Figure 4. Permissible forward LED current vs. temperature

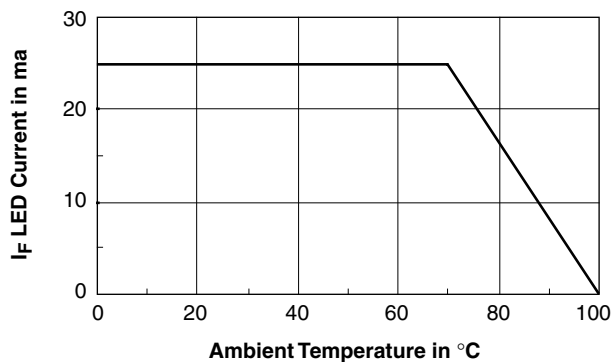

Figure 5. Permissible power dissipation vs. temperature

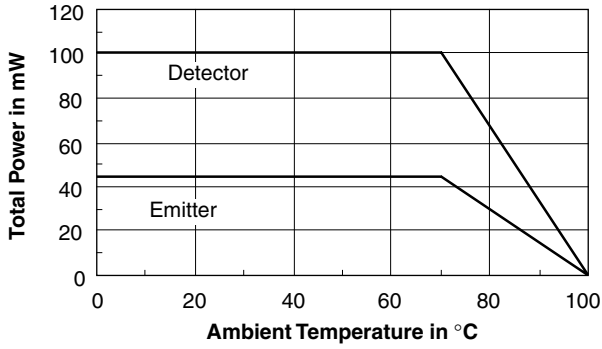

Figure 6. Output Current vs. Output Voltage
 ($T_A=25^\circ\text{C}$, $V_{CC}=5.0\text{ V}$)

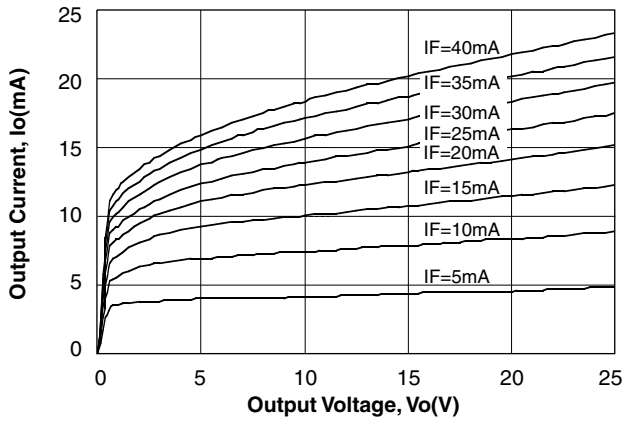

Figure 7. Output Current vs. Temperature
 @ $V_O=0.4\text{ V}$, $V_{CC}=5.0$

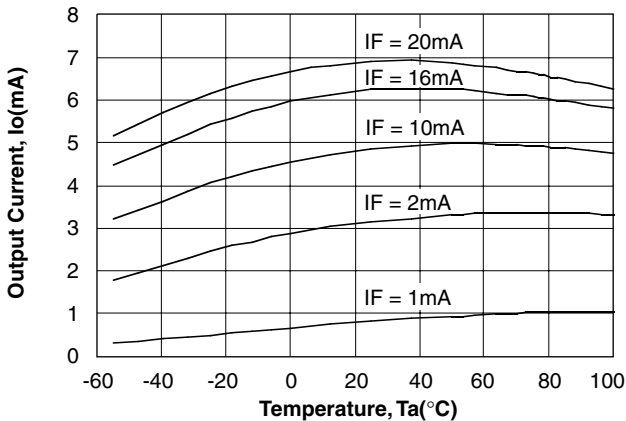

Figure 8. Propagation Delay vs. Temperature-6N136

@ $V_{CC}=5.0\text{ V}$, $I_F=16\text{ mA}$, $R_L=1.9\text{ k}\Omega$

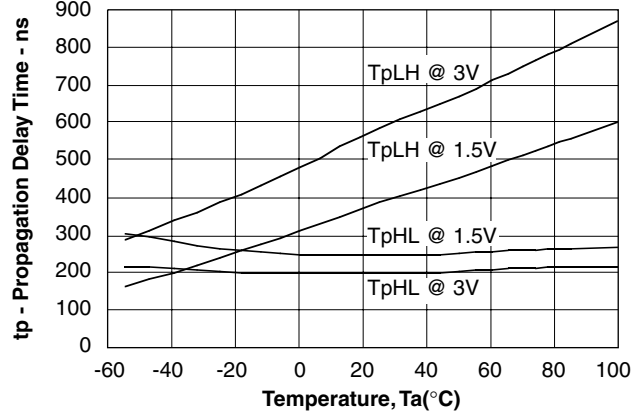

Figure 9. Propagation Delay vs. Temperature-6N135

@ $V_{CC}=5.0\text{ V}$, $I_F=16\text{ mA}$, $R_L=4.1\text{ k}\Omega$

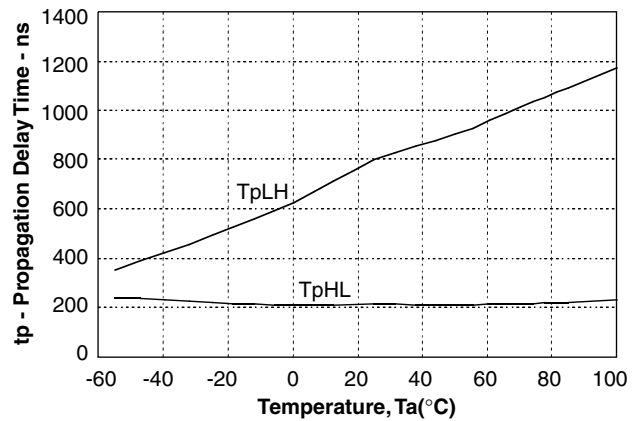

Figure 10. Logic High Output Current vs. Temperature

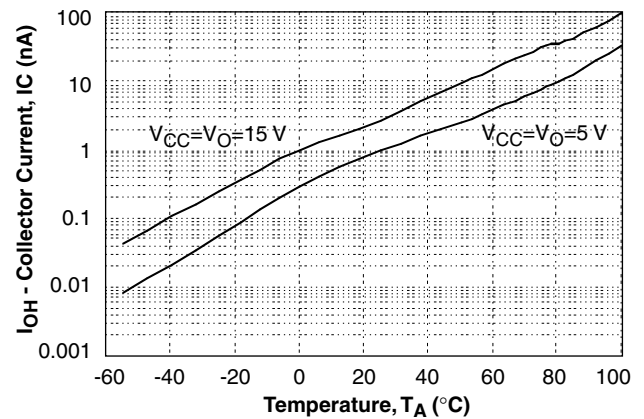

Figure 11. Small Signal Current Transfer Ratio vs. Quiescent Input Current ($V_{CC}=5.0\text{ V}$, $R_L=100\ \Omega$)

