

6203 - 2 Z

SKF Explorer

Dimensions

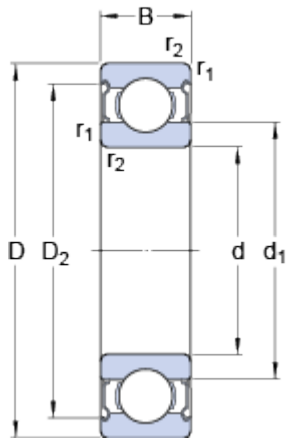

d	17	mm
D	40	mm
B	12	mm
d ₁	≈ 24.5	mm
D ₂	≈ 34.98	mm
r _{1,2}	min. 0.6	mm

Abutment dimensions

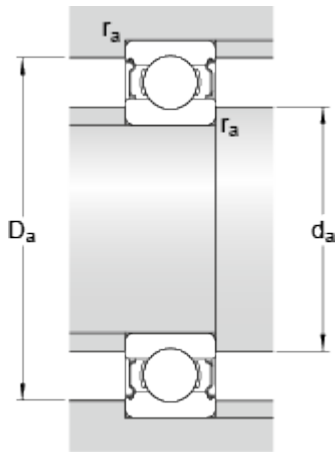

d _a	min. 21.2	mm
d _a	max. 24.4	mm
D _a	max. 35.8	mm
r _a	max. 0.6	mm

Calculation data

Basic dynamic load rating	C	9.95	kN
Basic static load rating	C ₀	4.75	kN
Fatigue load limit	P _u	0.2	kN
Reference speed		38000	r/min
Limiting speed		19000	r/min
Calculation factor	k _r	0.025	
Calculation factor	f ₀	13	

Mass

Mass bearing	0.068	kg
--------------	--------------	----

