

608 - 2 RSH

SKF Explorer

Dimensions

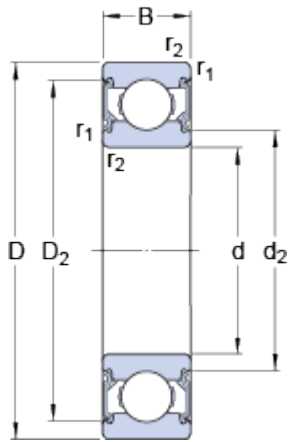

d	8	mm
D	22	mm
B	7	mm
d ₂	≈ 10.55	mm
D ₂	≈ 19.2	mm
r _{1,2}	min. 0.3	mm

Abutment dimensions

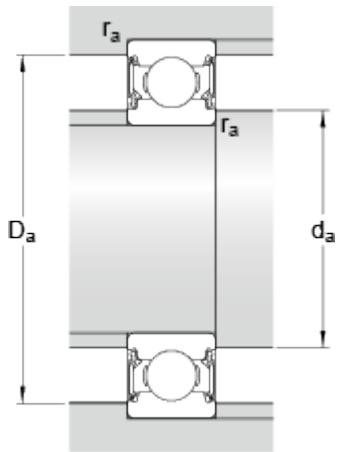

d _a	min. 10	mm
d _a	max. 10.5	mm
D _a	max. 20	mm
r _a	max. 0.3	mm

Calculation data

Basic dynamic load rating	C	3.45	kN
Basic static load rating	C ₀	1.37	kN
Fatigue load limit	P _u	0.057	kN
Limiting speed		22000	r/min
Calculation factor	k _r	0.025	
Calculation factor	f ₀	12	

Mass

Mass bearing		0.012	kg
--------------	--	--------------	----

