

5656 S

AC axial compact fan



ebm-papst St. Georgen GmbH & Co. KG

Hermann-Papst-Straße 1

D-78112 St. Georgen

Phone +49 7724 81-0

Fax +49 7724 81-1309

info2@de.ebmpapst.com

www.ebmpapst.com

Nominal data

Type	5656 S	
Phase		1~
Nominal voltage	VAC	230
Frequency	Hz	50
Speed	min ⁻¹	2700
Power input	W	30.0
Min. ambient temperature	°C	-35
Max. ambient temperature	°C	70
Air flow	m ³ /h	235
Sound power level	B	5.9
Sound pressure level	dB(A)	46

ml = max. load · me = max. efficiency · rfa = running at free air · cs = customer specs · cu = customer unit
Subject to alterations



Technical features

Dimensions	135 x 135 x 38 mm
General description	<p>AC voltage fan with external rotor motor shaded-pole motor. Protected from overload by a thermal cutout switch.</p> <p>Fan housing and impeller made of metal.</p> <p>Air exhaust over bars. Direction of rotation counter-clockwise seen on rotor.</p> <p>Electrical connection to 2 flat plugs 2.8 x 0.5 mm.</p> <p>Fan housing with grounding lug and tapping screw M4 x 8 (TORX).</p> <p>Mass 800 g.</p> <p>Please note our new ACmaxx series. With identical fastening dimensions and voltages, this series achieves higher energy efficiency.</p>
Connection line	2 flat plugs 2.8 x 0.5 mm. Housing with grounding lug and tapping screw M4 x 8 (TORX).
Direction of rotation	Left, looking at rotor
Direction of air flow	Air exhaust over bars
Bearing	Ball bearings
Lifetime L10 at 40 °C	45000 h
Lifetime L10 at maximum temperature	20000 h
Mass	0.800 kg
Housing material	Metal
Material of impeller	Metal
Motor protection	Protected from overload by a thermal cutout switch
Approval	VDE, CSA, UL, CE

Product drawing

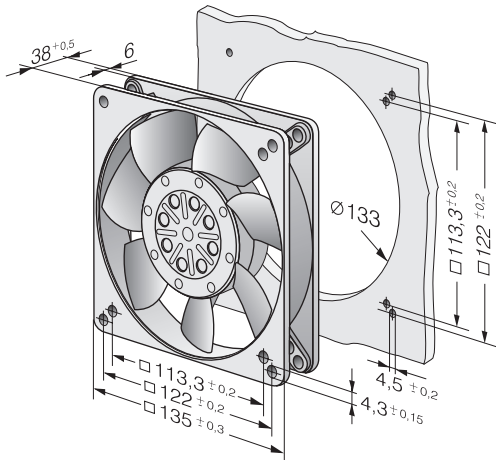

Charts: Air flow

