

Serie Protection

325PI Nylon Cable Chain with opening frames

Inner height (D) 25 mm

Single link construction with central large anti-friction pivot, for high torsion and tensile resistance.

Frames opening from inner radius.

Vertical separators available.

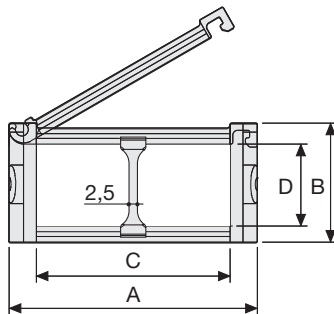

Separator

- Unassembled	Part.no S325L
- Assembled	Part.no S325LMC

Technical characteristics when self-supported

Speed	10 m/s
Acceleration	50 m/s ²

For higher requirements please consult our technical dept.

A	B	C	D	R	Weight/m	Chain
mm	mm	mm	mm	mm	kg	Part Number
57	38	40	25	075-100-125-150	1,15	325PI040 □□□*
77	38	60	25	075-100-125-150	1,30	325PI060 □□□*
93	38	76	25	075-100-125-150	1,40	325PI076 □□□*
120	38	103	25	075-100-125-150	1,70	325PI103 □□□*

*Complete the code by inserting the value of the radius (R): Ex. 325PI040 □□□□□

For sliding applications, technical data can slightly change according to frequency, added weight and environment.

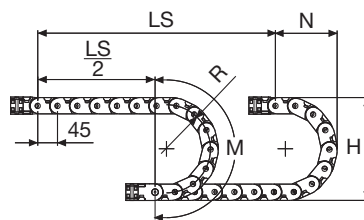

R	H	N	M	N1	M1
mm	mm	mm	mm	mm	mm
075	188	140	325	185	420
100	238	165	405	275	635
125	288	190	485	360	855
150	338	215	565	445	1075

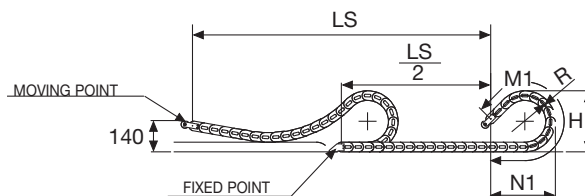

Length of chain (L)
Half travel distance ($\frac{LS}{2}$)
plus length of curve (M) or (M1)

$$L = \frac{LS}{2} + M \text{ o } M1$$



Self-Supporting Capacity Diagram

The maximum length of the self-supporting capacity ($\frac{LS}{2}$) in relationship to the weight of the cables and hoses contained per linear metre.

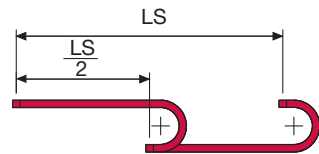
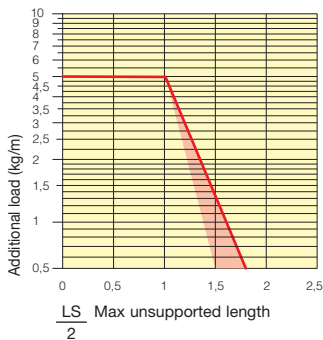

The red marking in the diagram area considers the difference of weight between various widths of chain.

For applications with $\frac{LS}{2}$ and weights not included in the area of the diagram showing self-supporting capacity, verify the possible use of support rollers (see page 30).

End Brackets

The end brackets set allows the two ends of the chain to be attached to the equipment. Set complete with tiewrap clamps available on request.

Nylon Type

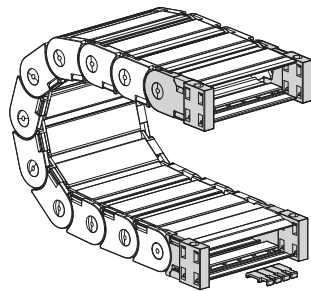

Fig. A Chain fixed outside/inside the radius. (Fig A)

Bright Zinc Plated Steel Type***

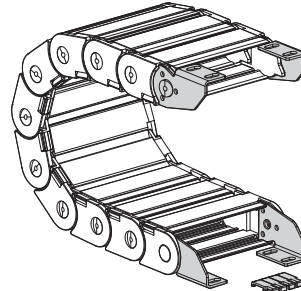
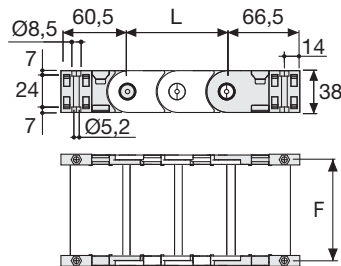

Fig. B Chain fixed outside or inside the radius. (Fig B)



Chain Type	F mm
325PI...040	51
325PI...060	71
325PI...076	87
325PI...103	114

Nylon Type Part Numbers

Complete Set Assembled	Chain	End Brackets
Type	Type	Set
325PI...	AN325P	□□□*KM

Complete Set Unassembled	Chain	End Brackets
Type	Type	Set
325PI...	AN325P	□□□*K

Tiewrap Clamp	Part Number
Assembled	CFC325L □□□*KM
Unassembled	CFC325L □□□*K

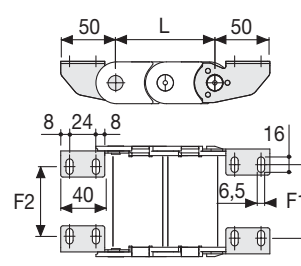

Chain Type	F2 mm	F1 mm
325PI...040	22	25,5
325PI...060	42	45,5
325PI...076	58	61,5
325PI...103	85	88,5

Bright Zinc Plated Steel Type Part Numbers

Complete Set Assembled	Chain	End Brackets
Type	Type	Set
325PI...	A325L	LK

Tiewrap Clamp	Part Number
Assembled	CFC325L □□□*KM
Unassembled	CFC325L □□□*K

* Inner width (C)
*** Available on request in stainless steel

Serie Protection

325PI

Nylon Cable Chain with opening frames

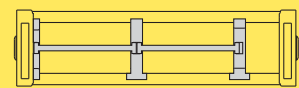

Separation System
To choose the separators see page. 188



Suitable to long travel distance.
To choose the guide channel see page 56

For further information please consult Brevetti Stendalto's Technical Office