



N-Channel Enhancement-Mode Vertical DMOS FETs

Features

- ▶ Free from secondary breakdown
- ▶ Low power drive requirement
- ▶ Ease of paralleling
- ▶ Low C_{ISS} and fast switching speeds
- ▶ Excellent thermal stability
- ▶ Integral source-drain diode
- ▶ High input impedance and high gain
- ▶ Complementary N- and P-Channel devices

Applications

- ▶ Motor controls
- ▶ Converters
- ▶ Amplifiers
- ▶ Switches
- ▶ Power supply circuits
- ▶ Drivers (relays, hammers, solenoids, lamps, memories, displays, bipolar transistors, etc.)

General Description

The Supertex 2N7000 is an enhancement-mode (normally-off) transistor that utilizes a vertical DMOS structure and Supertex's well-proven silicon-gate manufacturing process. This combination produces a device with the power handling capabilities of bipolar transistors, and the high input impedance and positive temperature coefficient inherent in MOS devices. Characteristic of all MOS structures, this device is free from thermal runaway and thermally-induced secondary breakdown.

Supertex's vertical DMOS FETs are ideally suited to a wide range of switching and amplifying applications where very low threshold voltage, high breakdown voltage, high input impedance, low input capacitance, and fast switching speeds are desired.

Ordering Information

Device	Package Option	BV_{DSS}/BV_{DGS} (V)	$R_{DS(ON)}$ (max) (Ω)	$I_{D(ON)}$ (min) (mA)
2N7000-G	TO-92	60	5.0	75

-G indicates package is RoHS compliant ('Green')



Absolute Maximum Ratings

Parameter	Value
Drain-to-source voltage	BV_{DSS}
Drain-to-gate voltage	BV_{DGS}
Gate-to-source voltage	$\pm 30V$
Operating and storage temperature	$-55^{\circ}C$ to $+150^{\circ}C$
Soldering temperature*	$+300^{\circ}C$

Absolute Maximum Ratings are those values beyond which damage to the device may occur. Functional operation under these conditions is not implied. Continuous operation of the device at the absolute rating level may affect device reliability. All voltages are referenced to device ground.

* Distance of 1.6mm from case for 10 seconds.

Pin Configuration

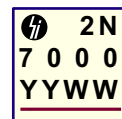

YY = Year Sealed
 WW = Week Sealed
 _____ = "Green" Packaging

TO-92

Thermal Characteristics

Package	I_D (continuous) [†] (mA)	I_D (pulsed) (mA)	Power Dissipation @ $T_c = 25^\circ\text{C}$ (W)	θ_{jc} ($^\circ\text{C}/\text{W}$)	θ_{ja} ($^\circ\text{C}/\text{W}$)	I_{DR}^{\dagger} (mA)	I_{DRM} (mA)
TO-92	200	500	1.0	125	170	200	500

Notes:

[†] I_D (continuous) is limited by max rated T_r .

Electrical Characteristics ($T_A = 25^\circ\text{C}$ unless otherwise specified)

Sym	Parameter	Min	Typ	Max	Units	Conditions
BV_{DSS}	Drain-to-source breakdown voltage	60	-	-	V	$V_{GS} = 0V, I_D = 10\mu\text{A}$
$V_{GS(th)}$	Gate threshold voltage	0.8	-	3.0	V	$V_{GS} = V_{DS}, I_D = 1.0\text{mA}$
I_{GSS}	Gate body leakage current	-	-	10	nA	$V_{GS} = \pm 15V, V_{DS} = 0V$
I_{DSS}	Zero gate voltage drain current	-	-	1.0	μA	$V_{GS} = 0V, V_{DS} = 48V$
		-	-	1.0	mA	$V_{GS} = 0V, V_{DS} = 48V,$ $T_A = 125^\circ\text{C}$
$I_{D(ON)}$	On-state drain current	75	-	-	mA	$V_{GS} = 4.5V, V_{DS} = 10V$
$R_{DS(ON)}$	Static drain-to-source on-state resistance	-	-	5.3	Ω	$V_{GS} = 4.5V, I_D = 75\text{mA}$
		-	-	5.0		$V_{GS} = 10V, I_D = 500\text{mA}$
G_{FS}	Forward transconductance	100	-	-	mmho	$V_{DS} = 10V, I_D = 200\text{mA}$
C_{ISS}	Input capacitance	-	-	60	pF	$V_{GS} = 0V, V_{DS} = 25V,$ $f = 1.0\text{MHz}$
C_{OSS}	Common source output capacitance	-	-	25		
C_{RSS}	Reverse transfer capacitance	-	-	5		
$t_{(ON)}$	Turn-on time	-	-	10	ns	$V_{DD} = 15V, I_D = 500\text{mA},$ $R_{GEN} = 25\Omega$
$t_{(OFF)}$	Turn-off time	-	-	10		
V_{SD}	Diode forward voltage drop	-	0.85	-	V	$V_{GS} = 0V, I_{SD} = 200\text{mA}$

Notes:

1. All D.C. parameters 100% tested at 25°C unless otherwise stated. (Pulse test: $300\mu\text{s}$ pulse, 2% duty cycle.)
2. All A.C. parameters sample tested.

Switching Waveforms and Test Circuit

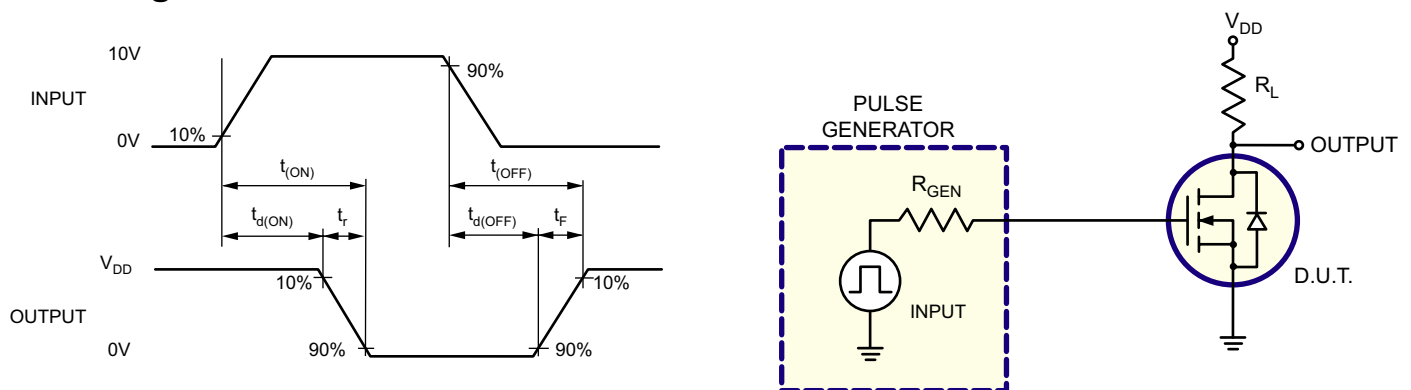

Typical Performance Curves

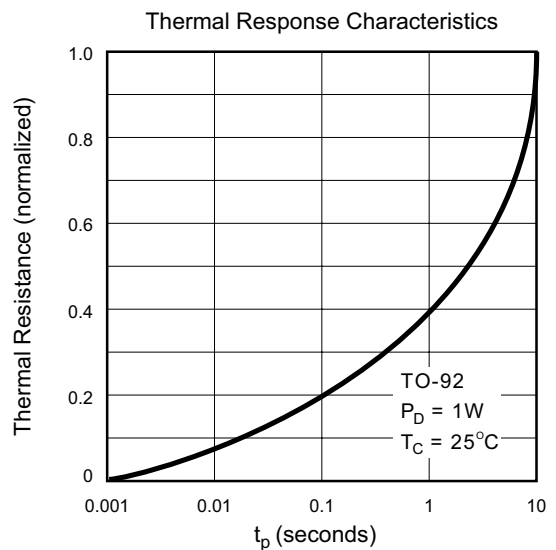
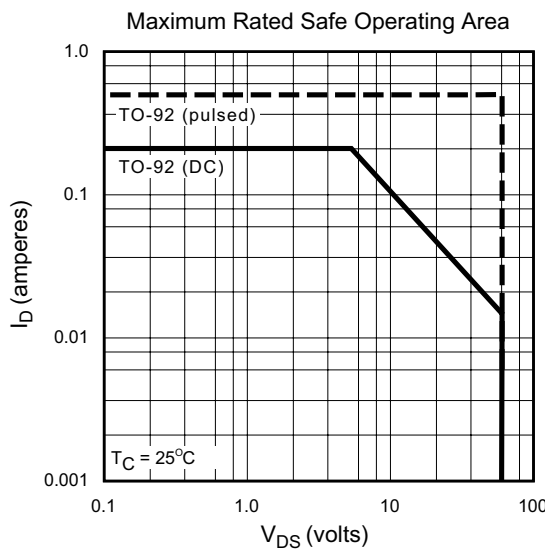
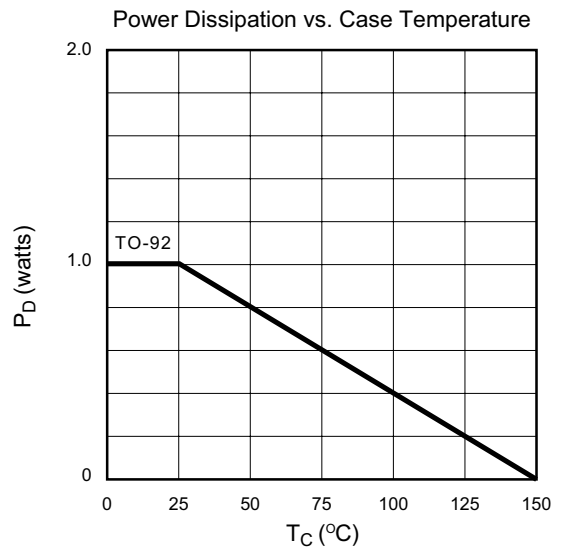
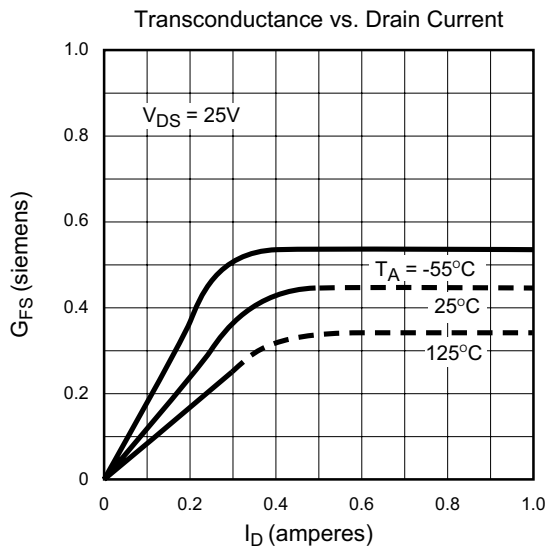
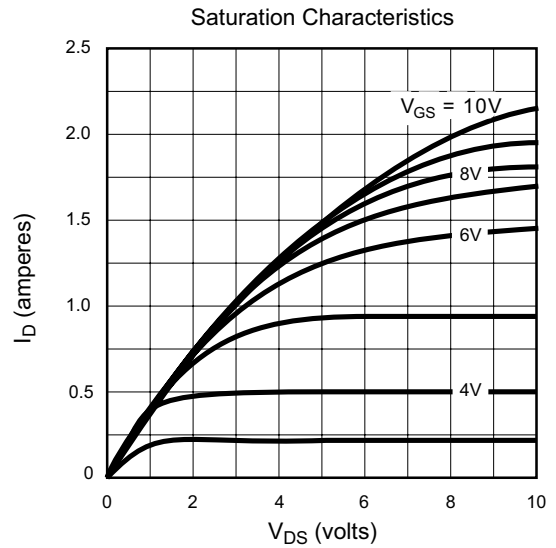
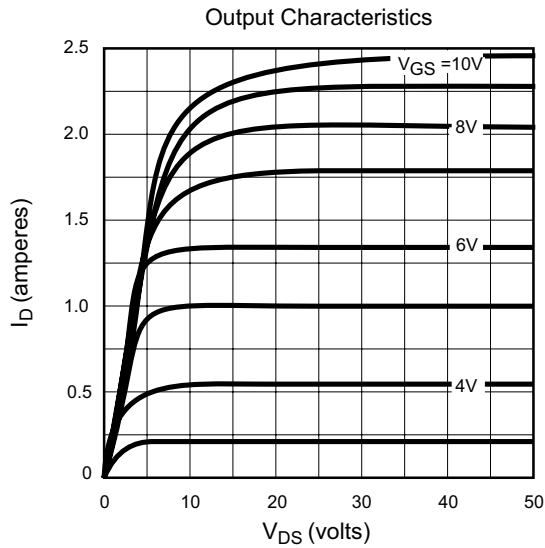

Typical Performance Curves (cont.)

BV_{DSS} Variation with Temperature

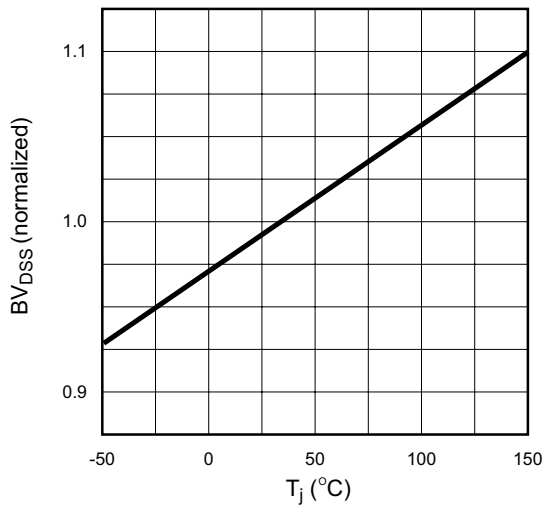

On-Resistance vs. Drain Current

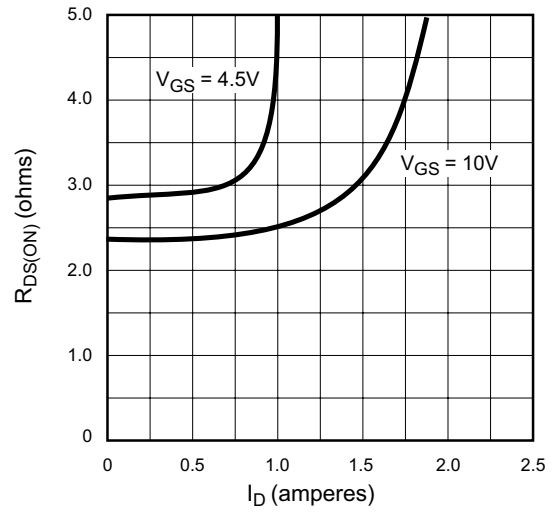

Transfer Characteristics

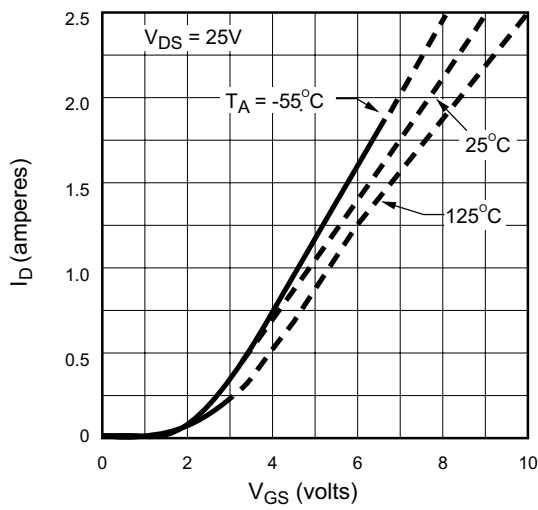

$V_{(th)}$ and R_{DS} Variation with Temperature

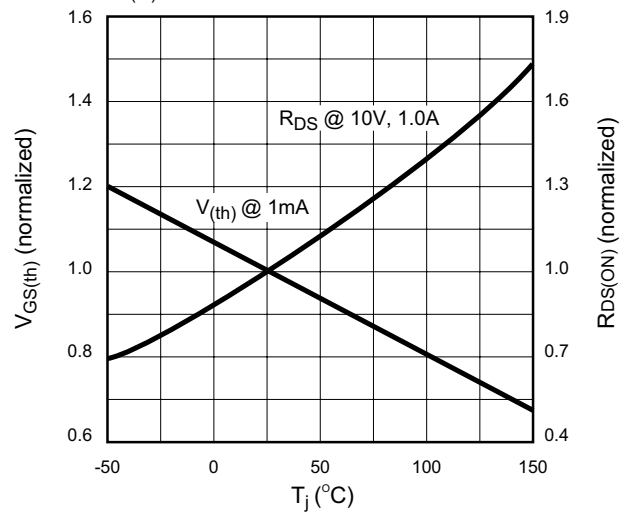

Capacitance vs. Drain-to-Source Voltage

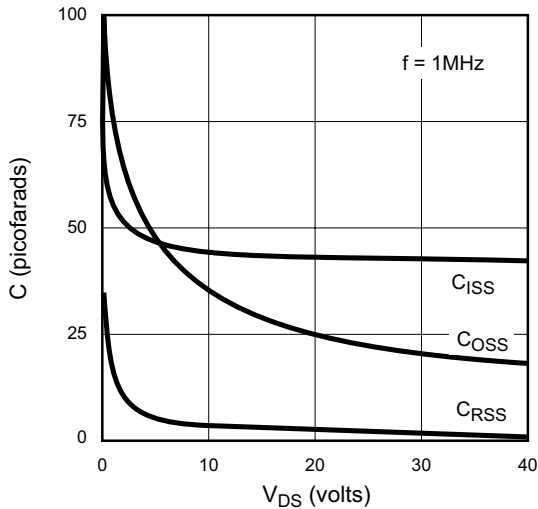

Gate Drive Dynamic Characteristics

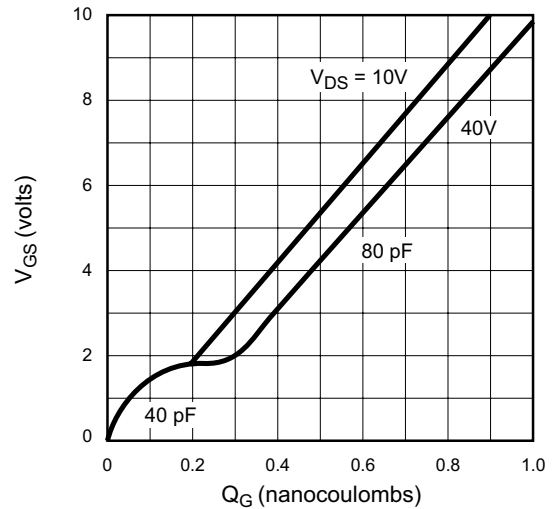

3-Lead TO-92 Package Outline (N3)

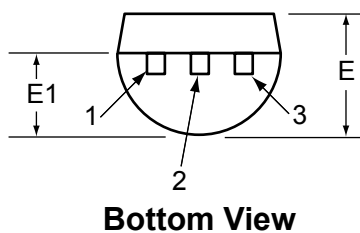
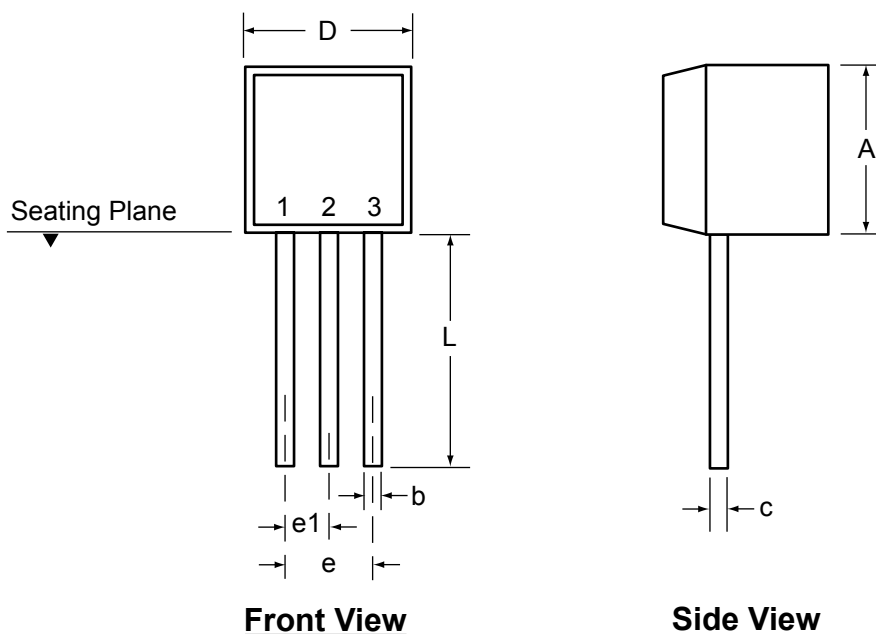

Symbol		A	b	c	D	E	E1	e	e1	L
Dimensions (inches)	MIN	.170	.014 [†]	.014 [†]	.175	.125	.080	.095	.045	.500
	NOM	-	-	-	-	-	-	-	-	-
	MAX	.210	.022 [†]	.022 [†]	.205	.165	.105	.105	.055	.610*

JEDEC Registration TO-92.

* This dimension is not specified in the original JEDEC drawing. The value listed is for reference only.

† This dimension is a non-JEDEC dimension.

Drawings not to scale.

Supertex Doc.#: DSPD-3TO92N3, Version D080408.

(The package drawing(s) in this data sheet may not reflect the most current specifications. For the latest package outline information go to <http://www.supertex.com/packaging.html>.)

Supertex inc. does not recommend the use of its products in life support applications, and will not knowingly sell them for use in such applications unless it receives an adequate "product liability indemnification insurance agreement." Supertex inc. does not assume responsibility for use of devices described, and limits its liability to the replacement of the devices determined defective due to workmanship. No responsibility is assumed for possible omissions and inaccuracies. Circuitry and specifications are subject to change without notice. For the latest product specifications refer to the Supertex inc. website: <http://www.supertex.com>.