

Technical data sheet

Intermediate expansion connector, metric thread

Item no. 2031452

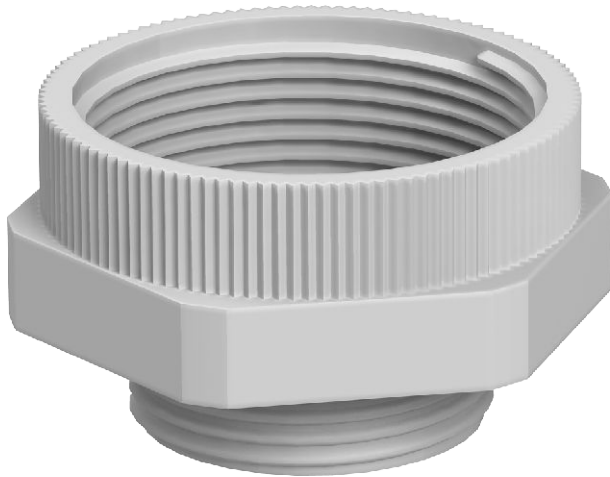

Intermediate expansion connector, metric internal and external thread.



PA Polyamide

Master data

Item no.	2031452
Type	107 E M 20-25 PA
Description 1	Extension
Description 2	M - M
Dimension	M20-M25
Colour	Light grey
RAL number	7035
Material	Polyamide
Material symbol	PA
Smallest sales unit (VG)	50,00 Piece
Weight	0,63 kg/100 pc.

Technical data

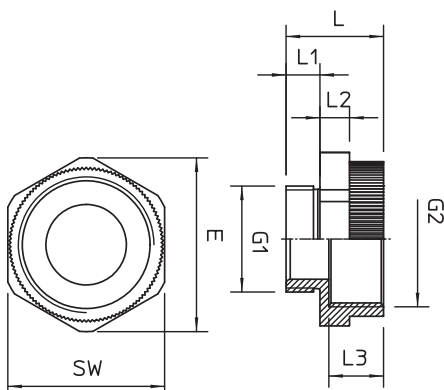

explosion-proof	<input type="checkbox"/>
Thread type: External thread	<input type="checkbox"/> Metric
Thread type: Internal thread	<input type="checkbox"/> Metric
External thread	<input type="checkbox"/> M20
Thread dimension, metric, external	<input type="checkbox"/> 20,00
Internal thread	<input type="checkbox"/> M25
Thread dimension, metric, internal	<input type="checkbox"/> 25,00
Nickel-plated	<input type="checkbox"/>