

No.	Changes and/or Note No.	Date	Intr	No	Changes and/or Note No.	Date	Intr
-----	-------------------------	------	------	----	-------------------------	------	------

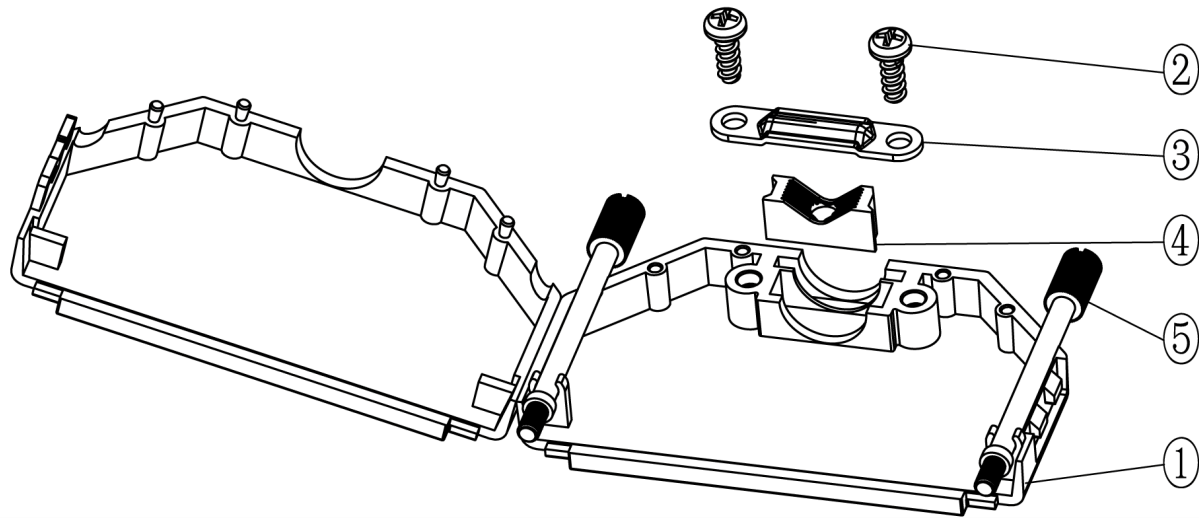
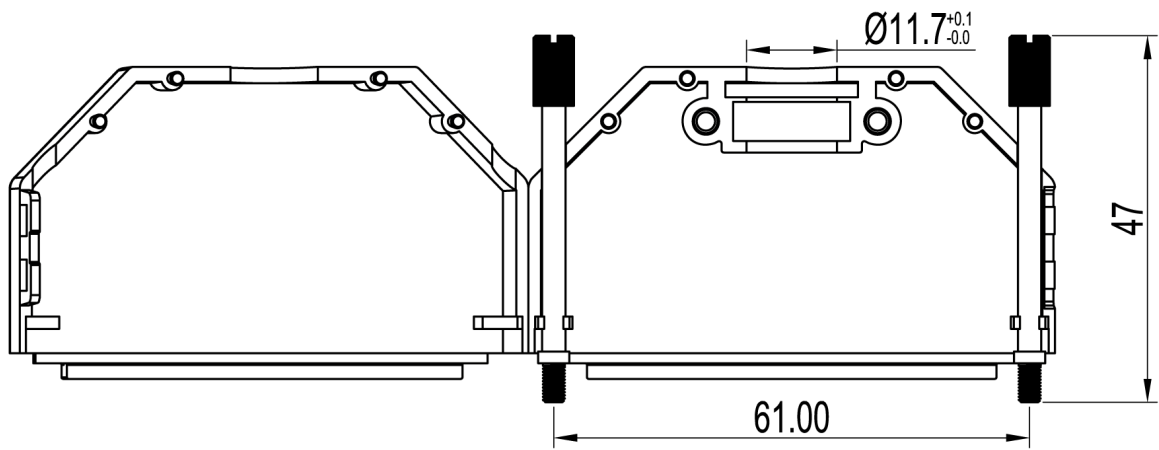
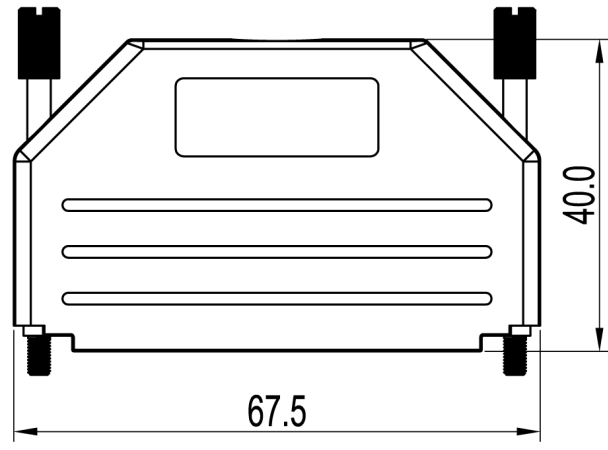
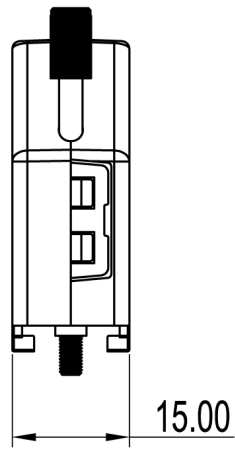

Part Number:	Description:	Pack:	Item	QTY	Part description
6353-0101-05	DPPK50-LG-K	Kit	1	1	DPPK-50 Cover
			2	2	EPS 3X8 Self Tapping Screw
6354-0101-05	DPPK50-LG	Bulk	3	1	Cable Clamp
			4	1	Plastic Insert
			5	2	UNC 4-40X47 Jackscrew

DATE: 2012-02-03	DRAWN: YGY	SCALE:	MATERIAL TYPE:	GENERAL TOLERANCES UNLESS OTHERWISE STATED LINEAR 0 ±0.20 0.0 ±0.15 0.00 ±0.10 ANGULAR ±0°30' ALL DIMENSIONS IN mm THIRD ANGLE PROJECTION
AUDITING:	APPROVED: MRR		REPLACES:	