

1 2 3 4 5 6

A

B

C

D

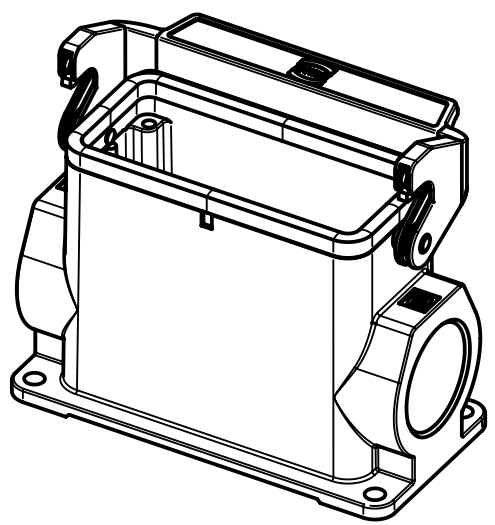
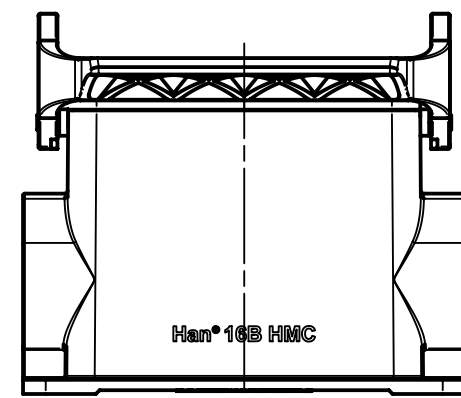
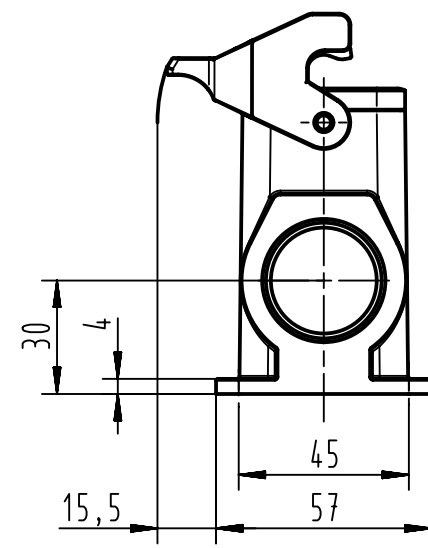
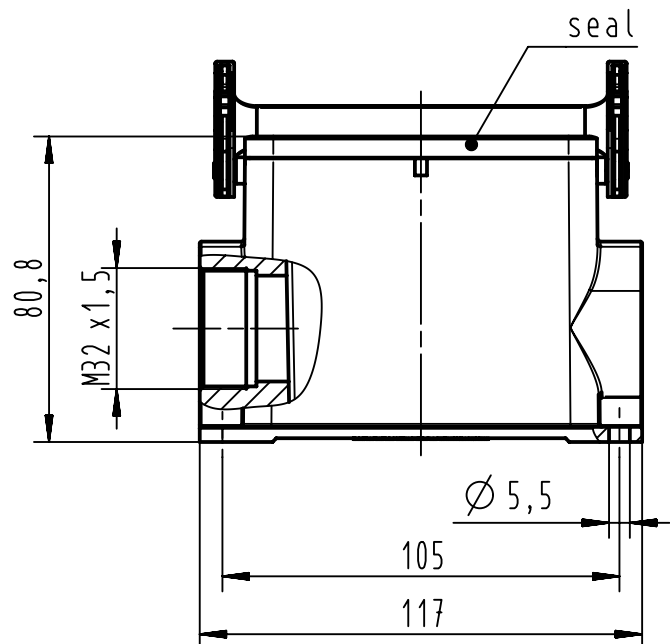

	All Dimensions in mm Original Size DIN A4	Scale		Free size tol.		Ref.	
		1:2				Sub.	
	All rights reserved Department EL PD - DE	Created by	Inspected by	Standardisation	Date	State	
		RULLKOETTER	BERGHORN	TIEMANNA	2013-03-25	Final Release	
HARTING Electric GmbH & Co. KG D-32339 Espelkamp		Title				Doc-Key / ECM-Nr.	
		Han 16B-HMC-asg1-LB-M32				100533992/UGD/002/A	
		Type	Number		Rev.	Page	
		TB	19 30 216 0252		A	1/1	