

# PCB connector - MSTB 2,5/10-ST-5,08



1757093

<https://www.phoenixcontact.com/pl/produkty/1757093>

Please be informed that the data shown in this PDF document is generated from our Online Catalog. Please find the complete data in the user documentation. Our General Terms of Use for Downloads are valid.



PCB connector, nominal cross section: 2.5 mm<sup>2</sup>, color: green, nominal current: 12 A, rated voltage (III/2): 320 V, contact surface: Tin, type of contact: Female connector, number of potentials: 10, number of rows: 1, number of positions: 10, number of connections: 10, product range: MSTB 2,5/...-ST, pitch: 5.08 mm, connection method: Screw connection with tension sleeve, screw head form: L Slotted, conductor/PCB connection direction: 0 °, locking clip: - Locking clip, plug-in system: COMBICON MSTB 2,5, locking: without, mounting: without, type of packaging: packed in cardboard

## Your advantages

- Well-known connection principle allows worldwide use
- Low temperature rise, thanks to maximum contact force
- Allows connection of two conductors

## Commercial Data

Item number	1757093
Packing unit	50 pc
Minimum order quantity	50 pc
Sales Key	AAAFAA
Product Key	AACAGC
Catalog Page	Page 262 (C-1-2013)
GTIN	4017918029623
Weight per Piece (including packing)	17.05 g
Weight per Piece (excluding packing)	16.604 g
Customs tariff number	85366990
Country of origin	DE

1757093

<https://www.phoenixcontact.com/pl/produkty/1757093>

## Technical Data

### Product properties

Type	Standard
Product line	COMBICON Connectors M
Product type	PCB plug
Number of positions	10
Pitch	5.08 mm
Number of connections	10
Number of rows	1
Mounting flange	without
Number of potentials	10

### Electrical properties

Nominal current $I_N$	12 A
Nominal voltage $U_N$	320 V
Degree of pollution	3
Contact resistance	1.3 mΩ
Rated voltage (III/3)	250 V
Rated surge voltage (III/3)	4 kV
Rated voltage (III/2)	320 V
Rated surge voltage (III/2)	4 kV

### Connection data

#### Connection technology

Type	Standard
Connector system	COMBICON MSTB 2,5
Nominal cross section	2.5 mm <sup>2</sup>
Type of contact	Female connector

#### Interlock

Locking type	without
Mounting flange	without

#### Conductor connection

Connection method	Screw connection with tension sleeve
Conductor/PCB connection direction	0 °
Conductor cross section solid	0.2 mm <sup>2</sup> ... 2.5 mm <sup>2</sup>
Conductor cross section flexible	0.2 mm <sup>2</sup> ... 2.5 mm <sup>2</sup>
Conductor cross section AWG	24 ... 12
Conductor cross section flexible, with ferrule without plastic sleeve	0.25 mm <sup>2</sup> ... 2.5 mm <sup>2</sup>
Conductor cross section, flexible, with ferrule, with plastic sleeve	0.25 mm <sup>2</sup> ... 2.5 mm <sup>2</sup>
2 conductors with same cross section, solid	0.2 mm <sup>2</sup> ... 1 mm <sup>2</sup>

# PCB connector - MSTB 2,5/10-ST-5,08

1757093

<https://www.phoenixcontact.com/pl/produkty/1757093>

2 conductors with same cross section, flexible	0.2 mm <sup>2</sup> ... 1.5 mm <sup>2</sup>
2 conductors with same cross section, flexible, with ferrule without plastic sleeve	0.25 mm <sup>2</sup> ... 1 mm <sup>2</sup>
2 conductors with the same cross section, flexible, with TWIN ferrule with plastic sleeve	0.5 mm <sup>2</sup> ... 1.5 mm <sup>2</sup>
Cylindrical gauge a x b / diameter	2.8 mm x 2.0 mm / 2.4 mm
Stripping length	7 mm
Tightening torque	0.5 Nm ... 0.6 Nm

## Material specifications

### Material data - contact

Note	WEEE/RoHS-compliant, free of whiskers according to IEC 60068-2-82/JEDEC JESD 201
Contact material	Cu alloy
Surface characteristics	hot-dip tin-plated
Metal surface terminal point (top layer)	Tin (5 - 7 µm Sn)
Metal surface contact area (top layer)	Tin (5 - 7 µm Sn)

### Material data - housing

Housing color	green (6021)
Insulating material	PA
Insulating material group	I
CTI according to IEC 60112	600
Flammability rating according to UL 94	V0
Glow wire flammability index GWFI according to EN 60695-2-12	850
Glow wire ignition temperature GWIT according to EN 60695-2-13	775
Temperature for the ball pressure test according to EN 60695-10-2	125 °C

## Dimensions

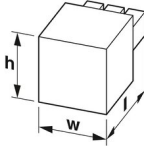
Dimensional drawing	
Pitch	5.08 mm
Width [w]	50.8 mm
Height [h]	15 mm
Length [l]	18.3 mm
Installed height	15 mm

## Mounting

Drive form screw head	Slotted (L)
-----------------------	-------------

## Notes

Notes on operation	In accordance with IEC 61984, COMBICON connectors have no switching power (COC). During designated use, they must not be plugged in or disconnected when carrying voltage or under load.
--------------------	--

## Mechanical tests

### Test for conductor damage and slackening

Specification	IEC 60999-1:1999-11
Result	Test passed

### Pull-out test

Specification	IEC 60999-1:1999-11
Conductor cross section/conductor type/tractive force setpoint/actual value	0.2 mm <sup>2</sup> / solid / > 10 N
	0.2 mm <sup>2</sup> / flexible / > 10 N
	2.5 mm <sup>2</sup> / solid / > 50 N
	2.5 mm <sup>2</sup> / flexible / > 50 N

### Insertion and withdrawal forces

Result	Test passed
No. of cycles	25
Insertion strength per pos. approx.	8 N
Withdraw strength per pos. approx.	6 N

### Torque test

Specification	IEC 60999-1:1999-11
---------------	---------------------

### Contact holder in insert

Specification	IEC 60512-15-1:2008-05
Contact holder in insert Requirements >20 N	Test passed

### Resistance of inscriptions

Specification	IEC 60068-2-70:1995-12
Result	Test passed

### Polarization and coding

Specification	IEC 60512-13-5:2006-02
Result	Test passed

### Visual inspection

Specification	IEC 60512-1-1:2002-02
Result	Test passed

### Dimension check

Specification	IEC 60512-1-2:2002-02
Result	Test passed

## Environmental and real-life conditions

### Vibration test

Specification	IEC 60068-2-6:2007-12
Frequency	10 - 150 - 10 Hz
Sweep speed	1 octave/min
Amplitude	0.35 mm (10 - 60.1 Hz)
Sweep speed	5g (60.1 - 150 Hz)
Test duration per axis	2.5 h

### Durability test

Specification	IEC 60512-9-1:2010-03
Impulse withstand voltage at sea level	4.8 kV
Contact resistance R <sub>1</sub>	1.3 mΩ
Contact resistance R <sub>2</sub>	1.4 mΩ
Insertion/withdrawal cycles	25

### Climatic test

Specification	ISO 6988:1985-02
Corrosive stress	0.2 dm <sup>3</sup> SO <sub>2</sub> on 300 dm <sup>3</sup> /40 °C/1 cycle
Thermal stress	100 °C/168 h
Power-frequency withstand voltage	2.21 kV

### Ambient conditions

Ambient temperature (operation)	-40 °C ... 100 °C (dependent on the derating curve)
Ambient temperature (storage/transport)	-40 °C ... 70 °C
Relative humidity (storage/transport)	30 % ... 70 %
Ambient temperature (assembly)	-5 °C ... 100 °C

## Electrical tests

### Thermal test | Test group C

Specification	IEC 60512-5-1:2002-02
Tested number of positions	12

### Insulation resistance

Specification	IEC 60512-3-1:2002-02
Insulation resistance, neighboring positions	> 5 MΩ

### Air clearances and creepage distances |

Specification	IEC 60664-1:2007-04
Insulating material group	I
Comparative tracking index (IEC 60112)	CTI 600
Rated insulation voltage (III/3)	250 V
Rated surge voltage (III/3)	4 kV
minimum clearance value - non-homogenous field (III/3)	3 mm

# PCB connector - MSTB 2,5/10-ST-5,08



1757093

<https://www.phoenixcontact.com/pl/produkty/1757093>

minimum creepage distance (III/3)	3.2 mm
Rated insulation voltage (III/2)	320 V
Rated surge voltage (III/2)	4 kV
minimum clearance value - non-homogenous field (III/2)	3 mm
minimum creepage distance (III/2)	3 mm
Rated insulation voltage (II/2)	630 V
Rated surge voltage (II/2)	4 kV
minimum clearance value - non-homogenous field (II/2)	3 mm
minimum creepage distance (II/2)	3.2 mm

## Packaging specifications

Type of packaging	packed in cardboard
-------------------	---------------------

Drawings

Diagram

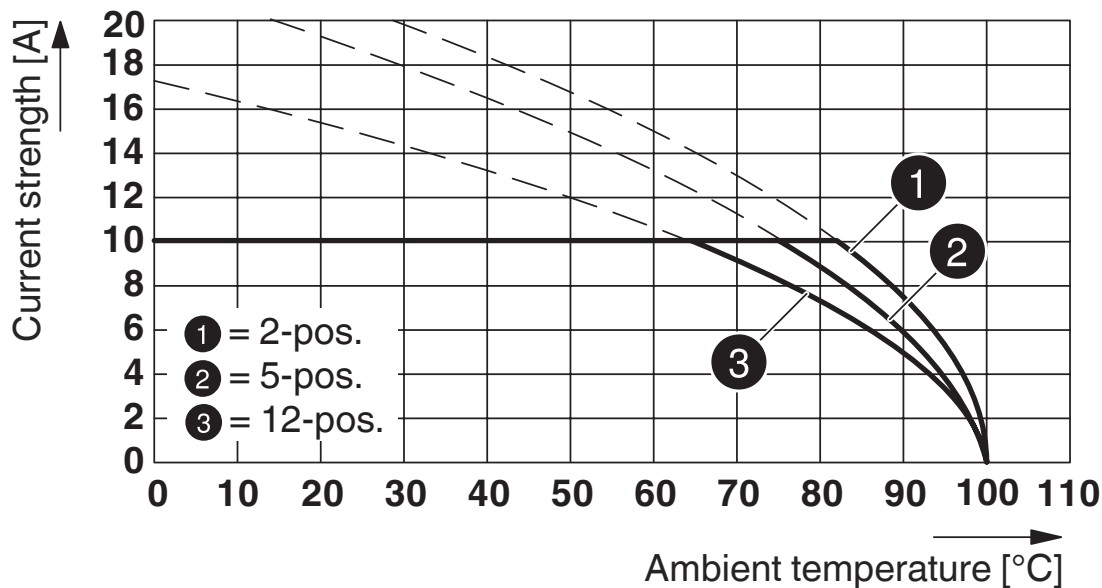

Type: MSTB 2,5/...-ST-5,08 with MDSTBW 2,5/...-G-5,08

Diagram

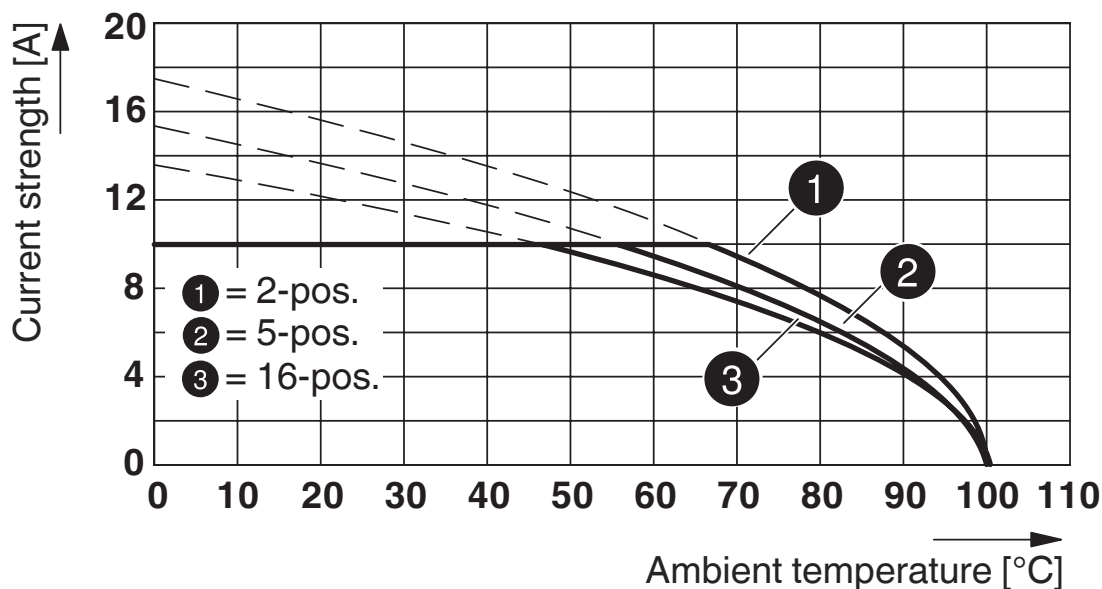

Type: MSTB 2,5/...-ST-5,08 with MDSTBV 2,5/...-G-5,08

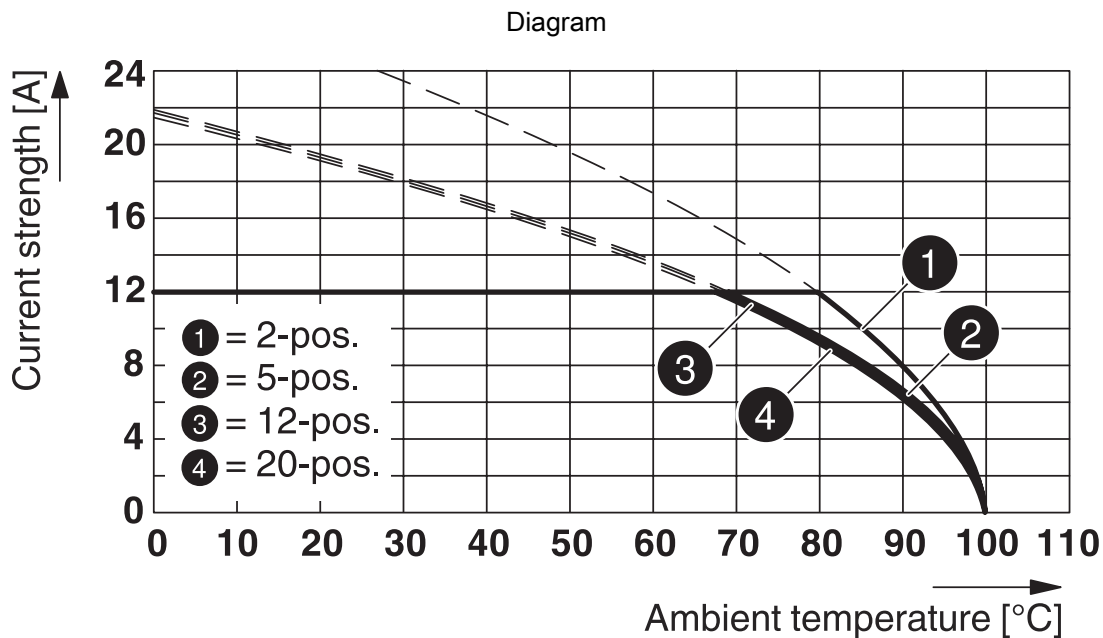

Type: MSTB 2,5/...-ST-5,08 with MVSTBU 2,5/...-GB-5,08

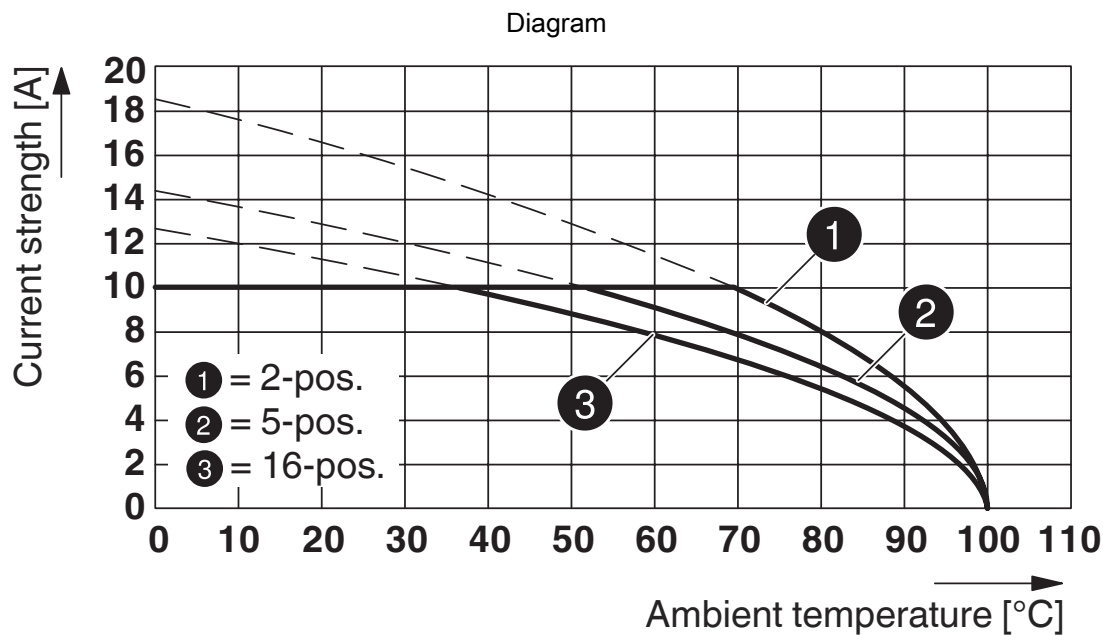

Type: MSTB 2,5/...-ST-5,08 with MDSTBVA 2,5/...-G-5,08



1757093

<https://www.phoenixcontact.com/pl/produkty/1757093>

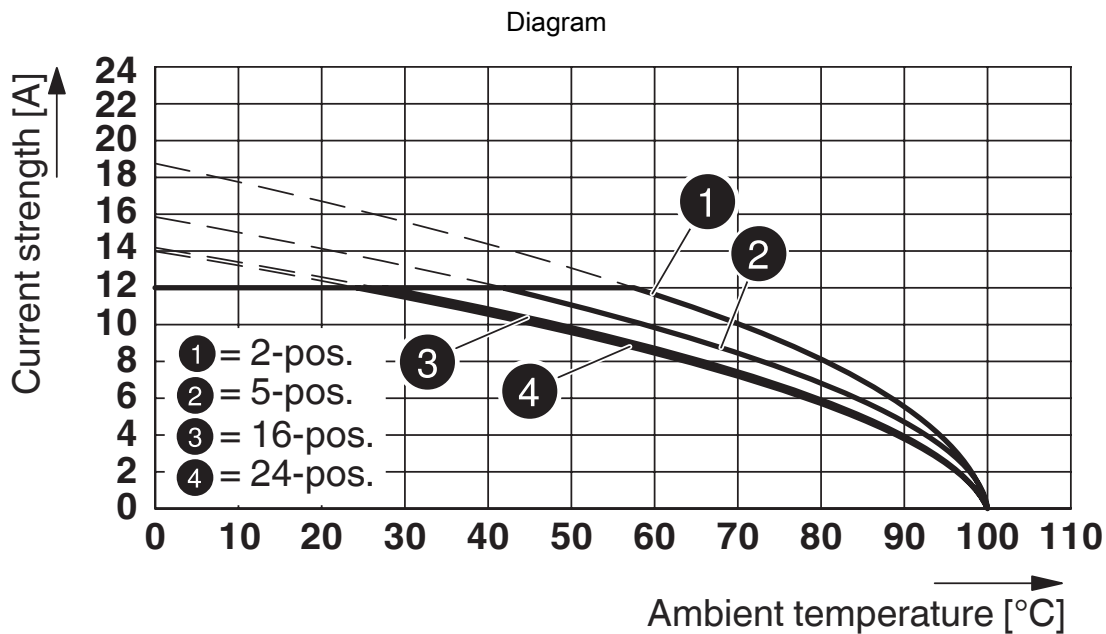

Type: MSTB 2,5/...-ST-5,08 with MSTBVA 2,5/...-G-5,08

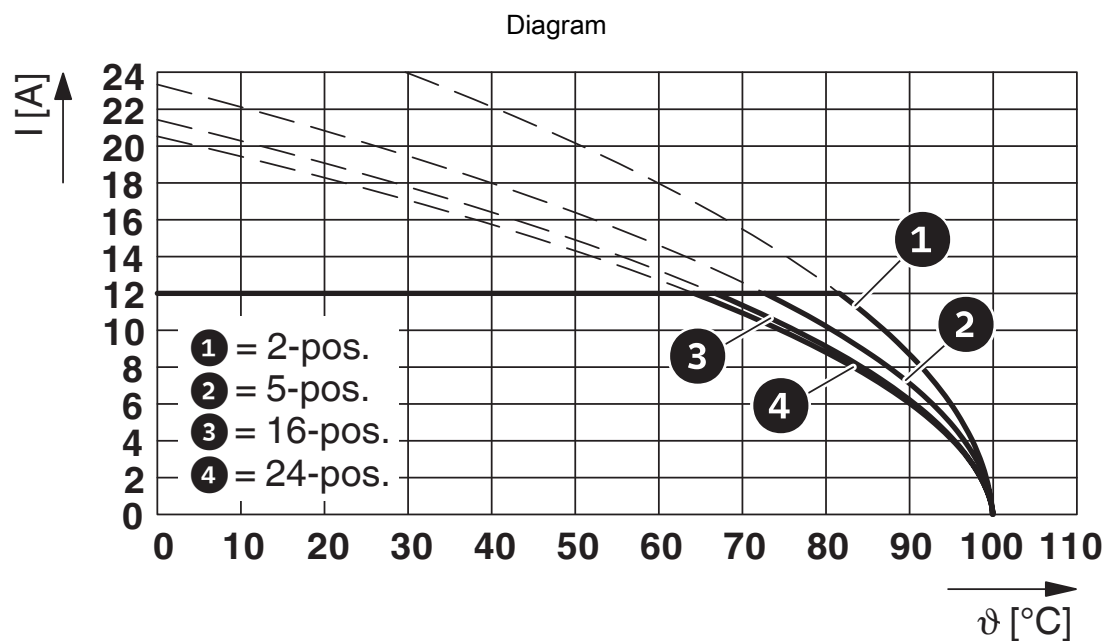

Type: MSTB 2,5/...-ST-5,08 with SMSTBA 2,5/...-G-5,08

1757093

<https://www.phoenixcontact.com/pl/produkty/1757093>

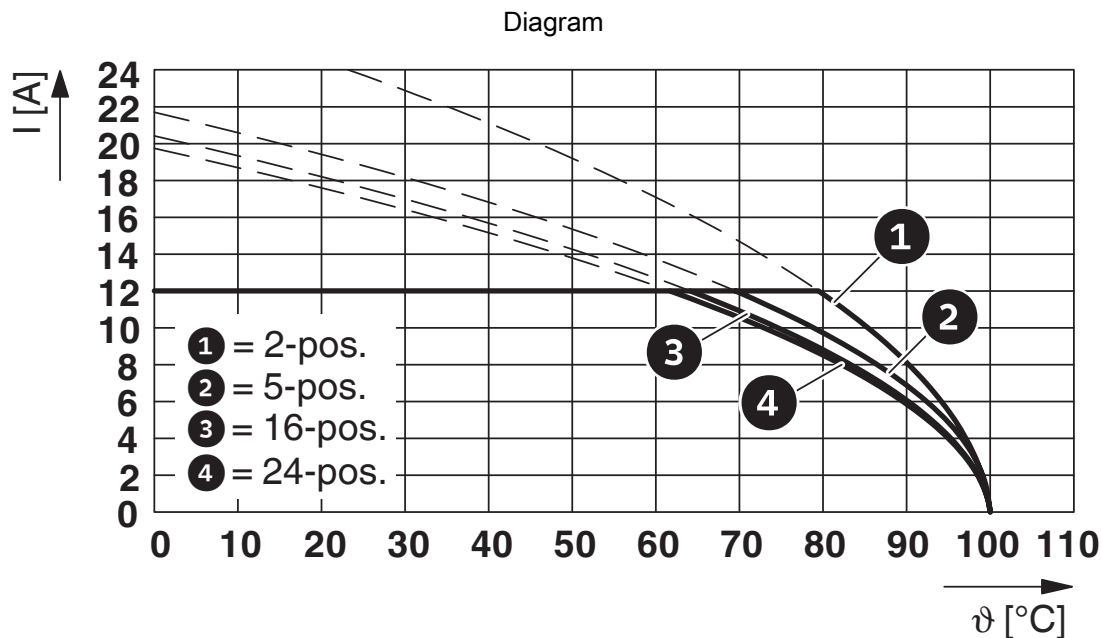

Type: MSTB 2,5/...-ST-5,08 with SMSTB 2,5/...-G-5,08

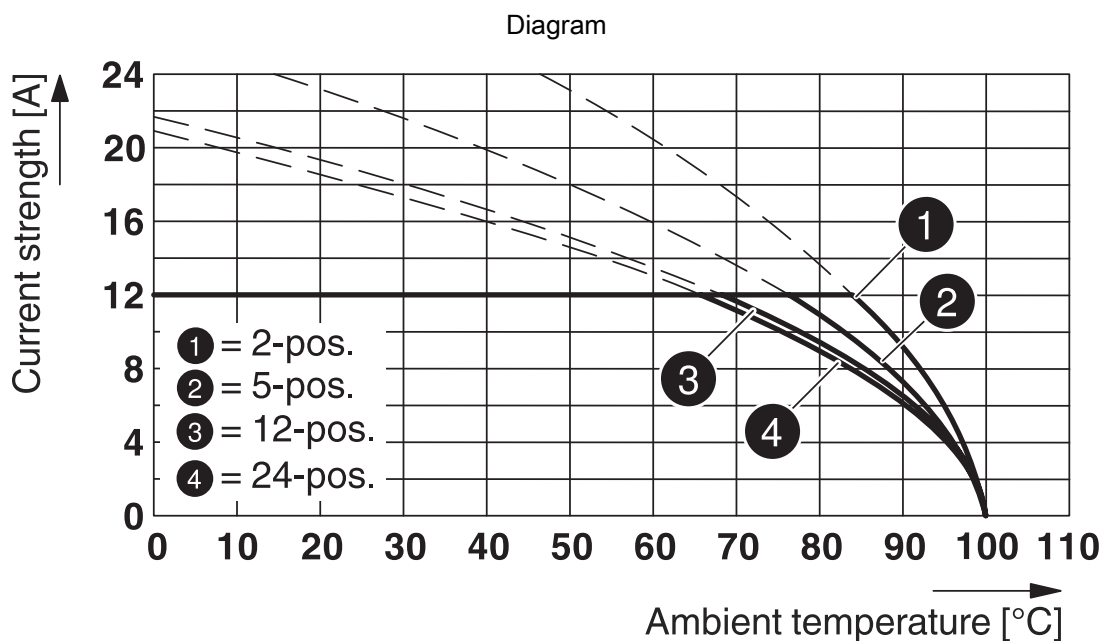

Type: MSTB 2,5/...-ST-5,08 with CCVA 2,5/...-G-5,08 P26THR

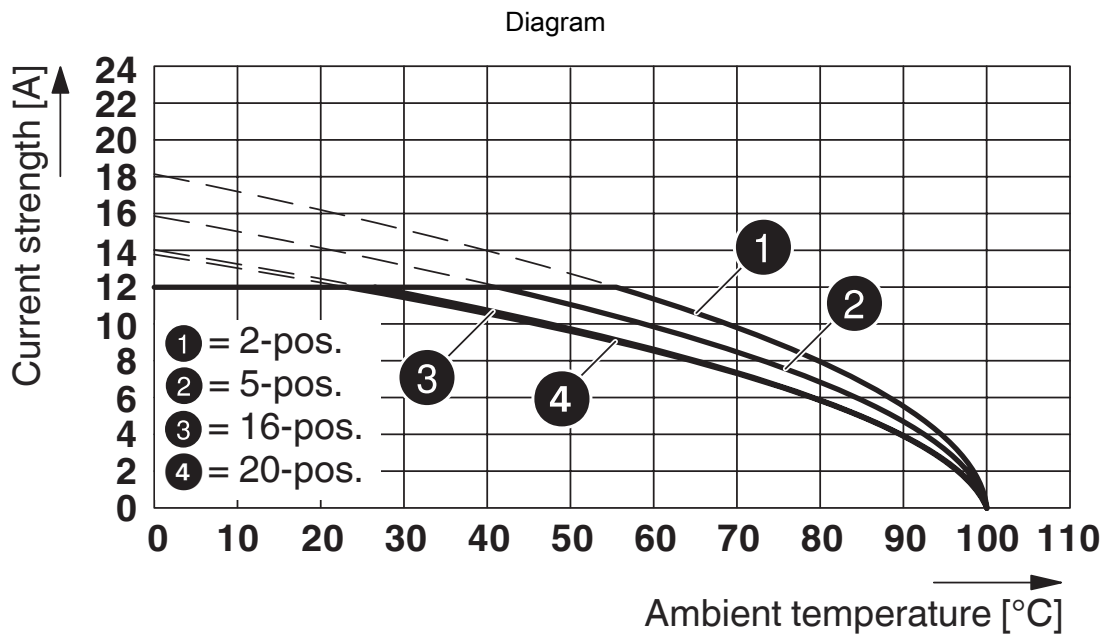

Type: MSTB 2,5/...-ST-5,08 with MSTBV 2,5/...-G-5,08

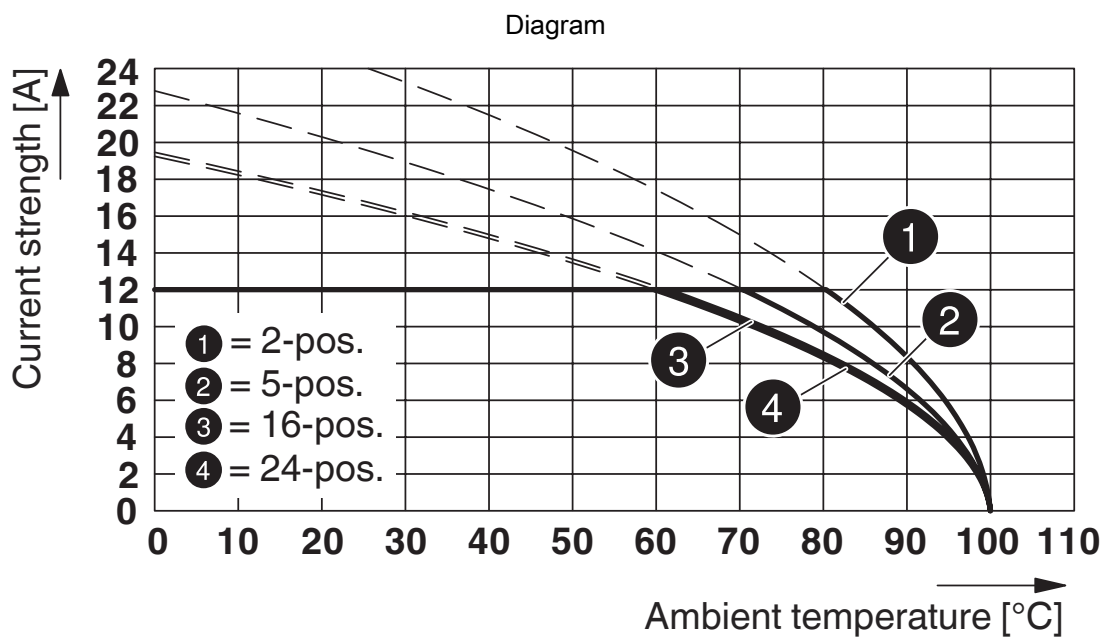

Type: MSTB 2,5/...-ST-5,08 with MSTBW 2,5/...-G-5,08

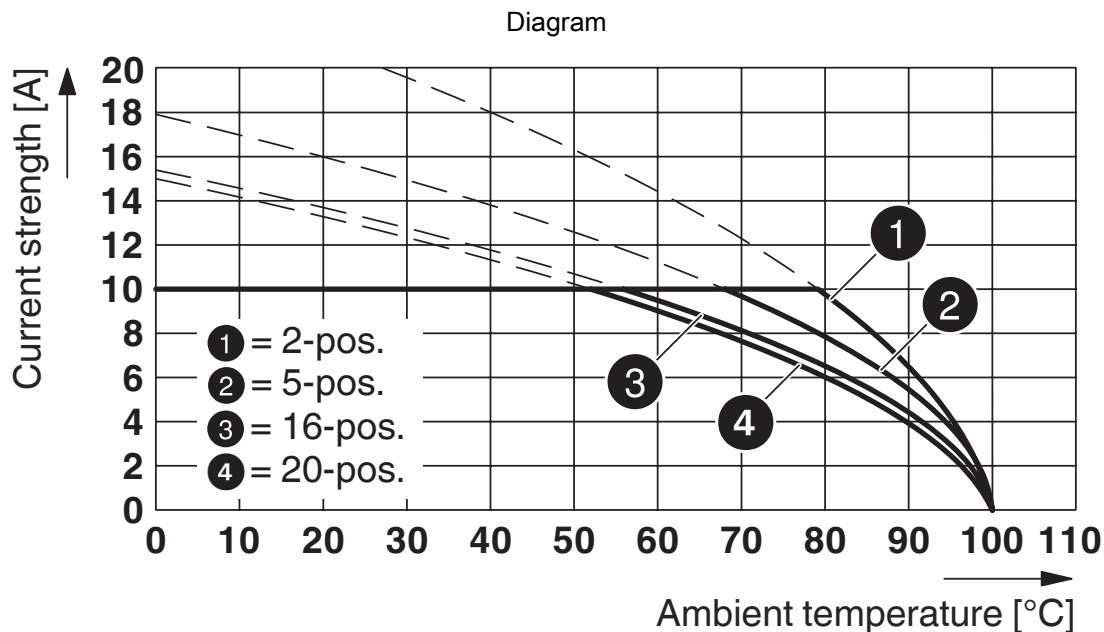

Type: MSTB 2,5/...-ST-5,08 with MDSTB 2,5/...-G1-5,08

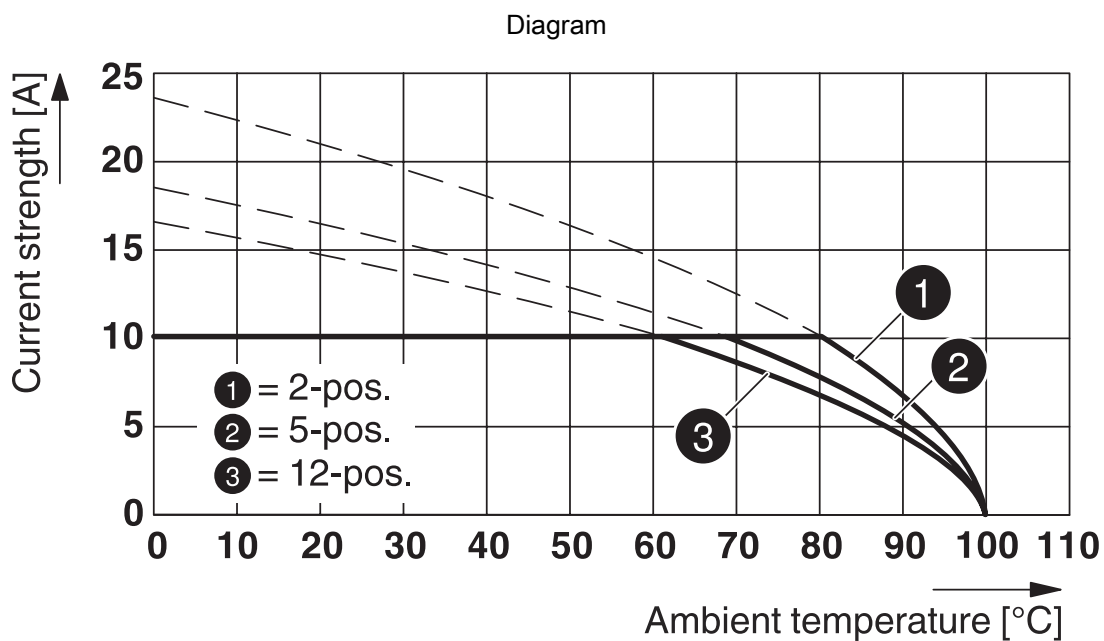

Type: MSTB 2,5/...-ST-5,08 with MDSTB 2,5/...-G-5,08

1757093

<https://www.phoenixcontact.com/pl/produkty/1757093>

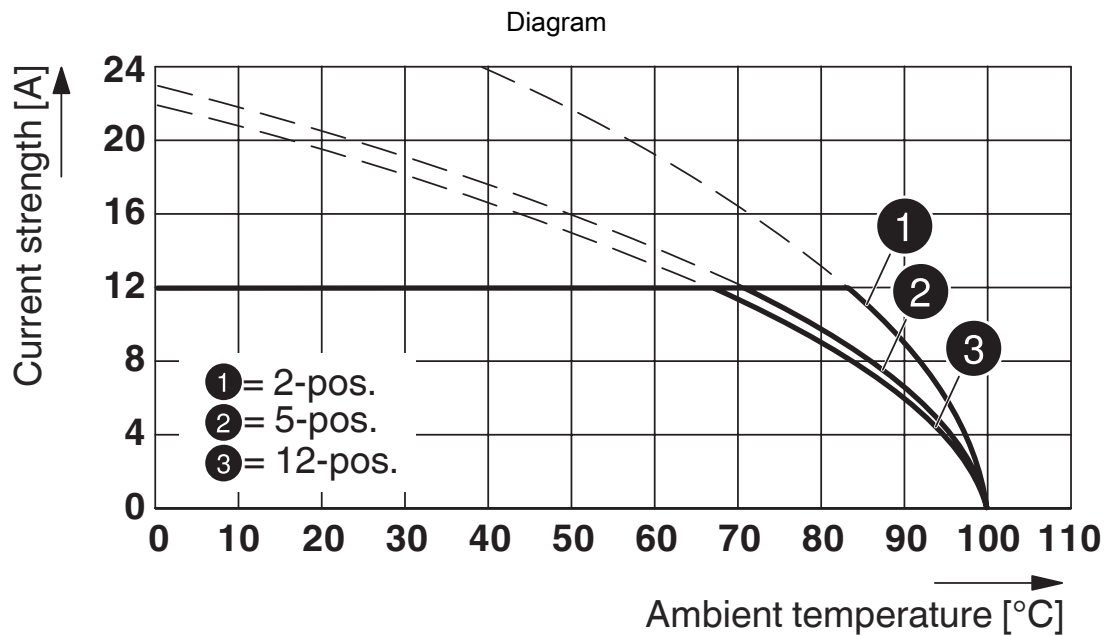

Type: MSTB 2,5/...-ST-5,08 with CC 2,5/...-G-5,08 P26THR

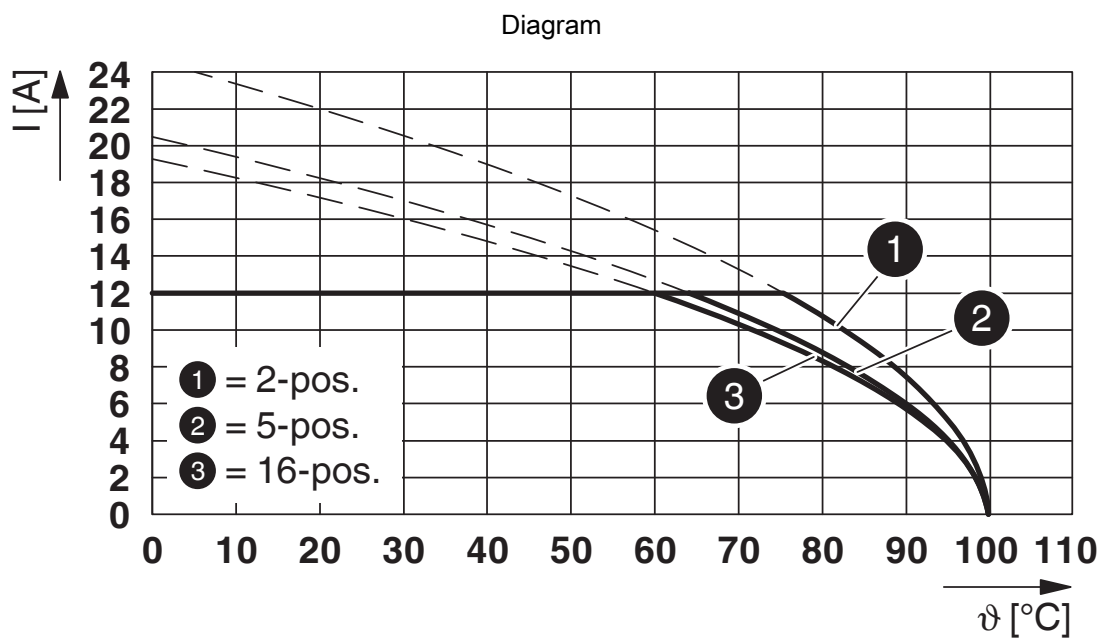

Type: MSTB 2,5/...-ST-5,08 with DFK-MSTBA 2,5/...-G-5,08

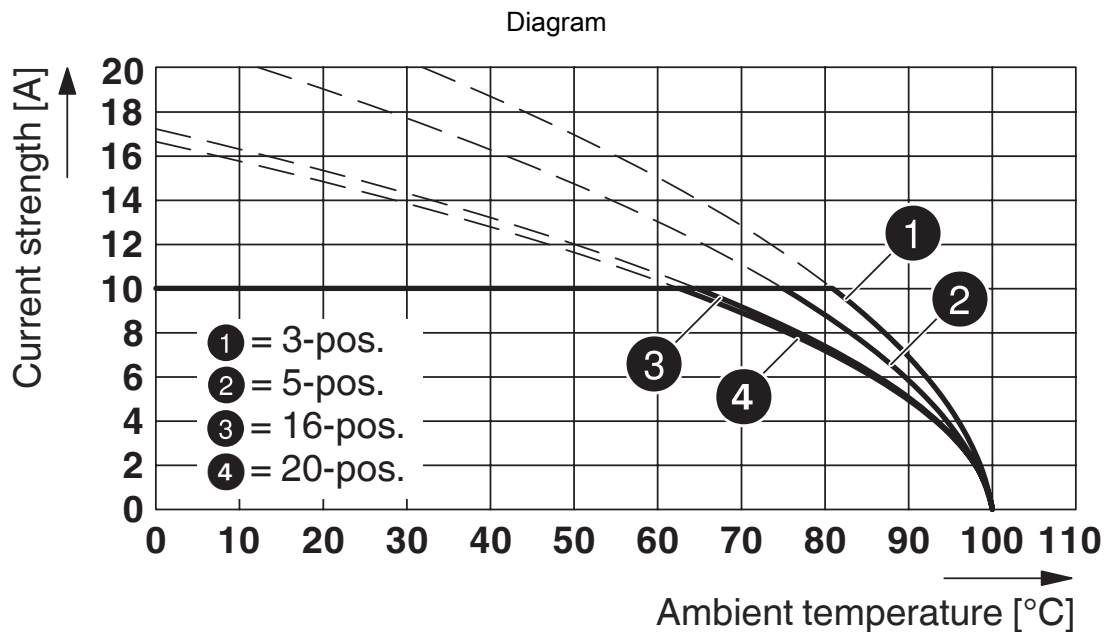

Type: MSTB 2,5/...-ST-5,08 with MDSTBV 2,5/...-G1-5,08

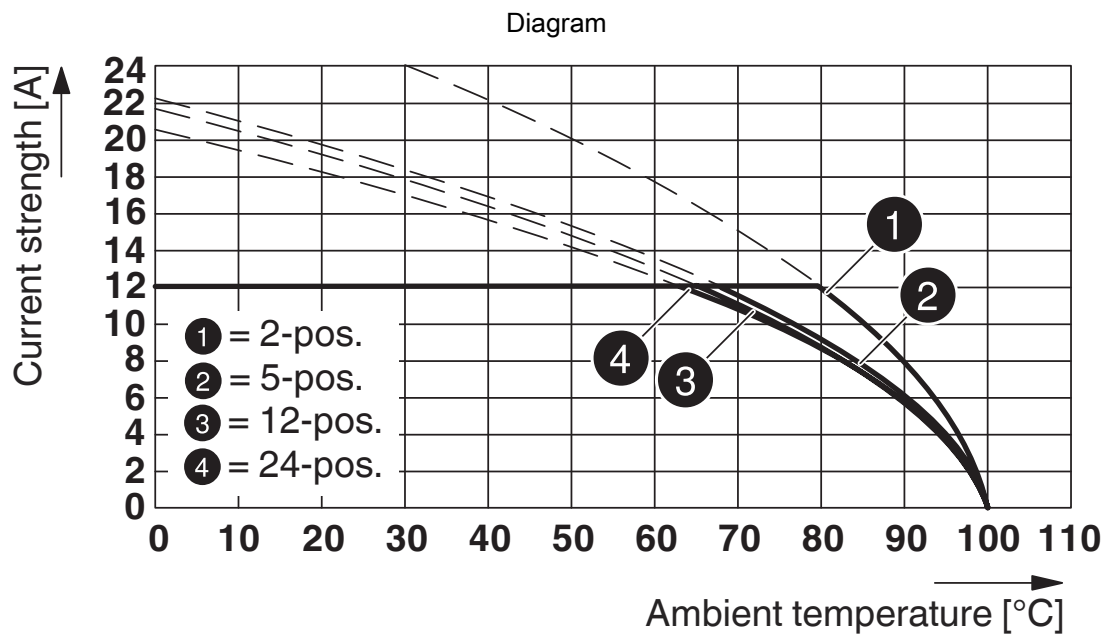

Type: MSTB 2,5/...-ST-5,08 with MSTB 2,5/...-G-5,08

1757093

<https://www.phoenixcontact.com/pl/produkty/1757093>

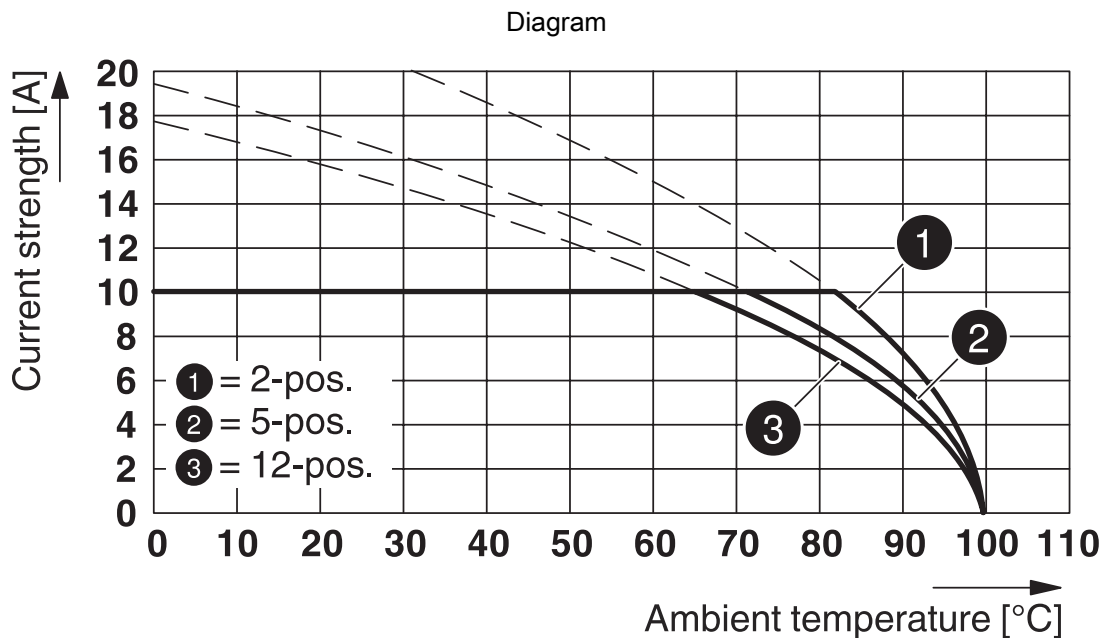

Type: MSTB 2,5/...-ST-5,08 with MDSTBA 2,5/...-G-5,08

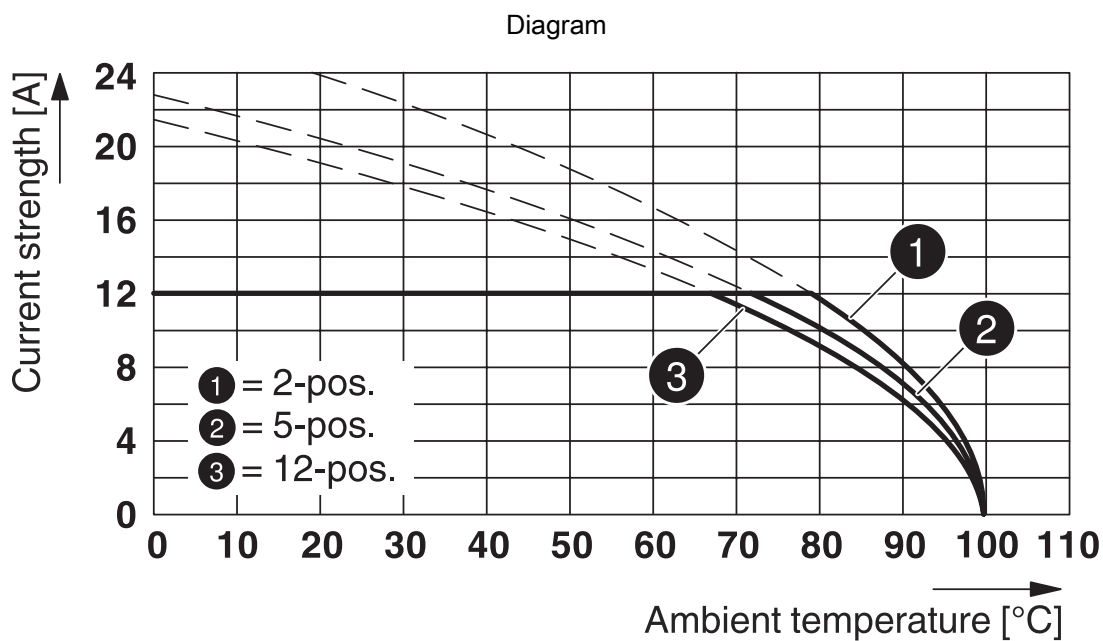

Type: MSTB 2,5/...-ST-5,08 with CCV 2,5/...-G-5,08 P26THR

# PCB connector - MSTB 2,5/10-ST-5,08



1757093

<https://www.phoenixcontact.com/pl/produkty/1757093>

## Approvals

 <b>CSA</b> Approval ID: LR13631-2585950				
	Nominal Voltage $U_N$	Nominal Current $I_N$	Cross Section AWG	Cross Section $\text{mm}^2$
Use group B	300 V	15 A	28 - 12	-
Use group D	300 V	10 A	28 - 12	-

 <b>IECEE CB Scheme</b> Approval ID: DE1-60988-B1B2				
	Nominal Voltage $U_N$	Nominal Current $I_N$	Cross Section AWG	Cross Section $\text{mm}^2$
	250 V	12 A	-	0.2 - 2.5

 <b>EAC</b> Approval ID: B.01687				
--	--	--	--	--

 <b>cULus Recognized</b> Approval ID: E60425-19931011				
	Nominal Voltage $U_N$	Nominal Current $I_N$	Cross Section AWG	Cross Section $\text{mm}^2$
Use group B	300 V	15 A	30 - 12	-
Use group D	300 V	10 A	30 - 12	-

 <b>VDE Zeichengenehmigung</b> Approval ID: 40050694				
	Nominal Voltage $U_N$	Nominal Current $I_N$	Cross Section AWG	Cross Section $\text{mm}^2$
	250 V	12 A	-	0.2 - 2.5



# PCB connector - MSTB 2,5/10-ST-5,08



1757093

<https://www.phoenixcontact.com/pl/produkty/1757093>

## Classifications

### ECLASS

ECLASS-9.0	27440309
ECLASS-10.0.1	27440309
ECLASS-11.0	27460202

### ETIM

ETIM 8.0	EC002638
----------	----------

### UNSPSC

UNSPSC 21.0	39121400
-------------	----------

# PCB connector - MSTB 2,5/10-ST-5,08



1757093

<https://www.phoenixcontact.com/pl/produkty/1757093>

## Environmental Product Compliance

China RoHS	Environmentally friendly use period: unlimited = EFUP-e
	No hazardous substances above threshold values

# PCB connector - MSTB 2,5/10-ST-5,08

1757093

<https://www.phoenixcontact.com/pl/produkty/1757093>

## Accessories

 Note: Applying some accessories below might limit this product.

### Insertion bridge

Insertion bridge - EBP 2- 5 - 1733169

<https://www.phoenixcontact.com/pl/produkty/1733169>

Insertion bridge for connectors with 5.0 mm or 5.08 mm pitch



 Max. current carrying capacity: 12 A

### Insertion bridge

Insertion bridge - EBP 3- 5 - 1733172

<https://www.phoenixcontact.com/pl/produkty/1733172>

Insertion bridge for connectors with 5.0 mm or 5.08 mm pitch



 Max. current carrying capacity: 12 A

# PCB connector - MSTB 2,5/10-ST-5,08

1757093

<https://www.phoenixcontact.com/pl/produkty/1757093>

## Insertion bridge

Insertion bridge - EBP 4- 5 - 1733185

<https://www.phoenixcontact.com/pl/produkty/1733185>



Insertion bridge for connectors with 5.0 mm or 5.08 mm pitch

 Max. current carrying capacity: 12 A

---

## Insertion bridge

Insertion bridge - EBP 5- 5 - 1733198

<https://www.phoenixcontact.com/pl/produkty/1733198>



Insertion bridge for connectors with 5.0 mm or 5.08 mm pitch

 Max. current carrying capacity: 12 A

# PCB connector - MSTB 2,5/10-ST-5,08

1757093

<https://www.phoenixcontact.com/pl/produkty/1757093>

## Insertion bridge

Insertion bridge - EBP 6- 5 - 1733208

<https://www.phoenixcontact.com/pl/produkty/1733208>

Insertion bridge for connectors with 5.0 mm or 5.08 mm pitch



 Max. current carrying capacity: 12 A

---

## Screwdriver

Screwdriver - SZS 0,6X3,5 - 1205053

<https://www.phoenixcontact.com/pl/produkty/1205053>



Actuation tool, for ST terminal blocks, insulated, also suitable for use as a bladed screwdriver, size: 0.6 x 3.5 x 100 mm, 2-component grip, with non-slip grip

# PCB connector - MSTB 2,5/10-ST-5,08

1757093

<https://www.phoenixcontact.com/pl/produkty/1757093>

## Marker card

Marker card - SK 5,08/3,8:FORTL.ZAHLEN - 0804293

<https://www.phoenixcontact.com/pl/produkty/0804293>

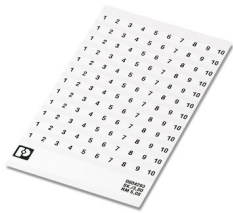

Marker card, white, labeled, horizontal: consecutive numbers 1 ... 10, 11 ... 20, etc. up to 91 ... (99)100, mounting type: adhesive, for terminal block width: 5.08 mm, lettering field size: 5.08 x 3.8 mm

---

## Cable housing

Cable housing - KGS-MSTB 2,5/10 - 1783740

<https://www.phoenixcontact.com/pl/produkty/1783740>



Cable housing, pitch: 0 mm, number of positions: 10, dimension a: 50 mm, color: green

# PCB connector - MSTB 2,5/10-ST-5,08



1757093

<https://www.phoenixcontact.com/pl/produkty/1757093>

## Coding profile

Coding profile - CP-MSTB - 1734634

<https://www.phoenixcontact.com/pl/produkty/1734634>

Coding profile, is inserted into the slot on the plug or inverted header, red insulating material



---

## Marker card

Marker card - SK U/2,8 WH:UNBEDRUCKT - 0803883

<https://www.phoenixcontact.com/pl/produkty/0803883>

Marker card, Sheet, white, unlabeled, can be labeled with: PLOTMARK, CMS-P1-PLOTTER, Office printing systems, mounting type: adhesive, for terminal block width: 210 mm, lettering field size: 186 x 2.8 mm, Number of individual labels: 3600



# PCB connector - MSTB 2,5/10-ST-5,08

1757093

<https://www.phoenixcontact.com/pl/produkty/1757093>

## PCB header

PCB header - MSTBW 2,5/10-G-5,08 - 1735808

<https://www.phoenixcontact.com/pl/produkty/1735808>

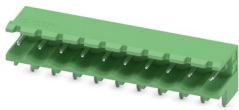

PCB headers, nominal cross section: 2.5 mm<sup>2</sup>, color: green, nominal current: 12 A, rated voltage (III/2): 320 V, contact surface: Tin, type of contact: Male connector, number of potentials: 10, number of rows: 1, number of positions: 10, number of connections: 10, product range: MSTBW 2,5/..-G, pitch: 5.08 mm, mounting: Wave soldering, pin layout: Linear pinning, solder pin [P]: 3.5 mm, number of solder pins per potential: 1, plug-in system: COMBICON MSTB 2,5, Pin connector pattern alignment: Standard, locking: without, mounting: without, type of packaging: packed in cardboard

## PCB header

PCB header - MSTBVA 2,5/10-G-5,08 - 1755817

<https://www.phoenixcontact.com/pl/produkty/1755817>

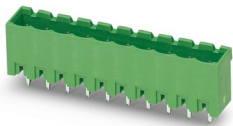

PCB headers, nominal cross section: 2.5 mm<sup>2</sup>, color: green, nominal current: 12 A, rated voltage (III/2): 320 V, contact surface: Tin, type of contact: Male connector, number of potentials: 10, number of rows: 1, number of positions: 10, number of connections: 10, product range: MSTBVA 2,5/..-G, pitch: 5.08 mm, mounting: Wave soldering, pin layout: Linear pinning, solder pin [P]: 3.9 mm, number of solder pins per potential: 1, plug-in system: COMBICON MSTB 2,5, Pin connector pattern alignment: Standard, locking: without, mounting: without, type of packaging: packed in cardboard



# PCB connector - MSTB 2,5/10-ST-5,08

1757093

<https://www.phoenixcontact.com/pl/produkty/1757093>

## PCB header

PCB header - CCVA 2,5/10-G-5,08 P26THR - 1955934

<https://www.phoenixcontact.com/pl/produkty/1955934>

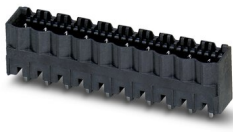

PCB headers, nominal cross section: 2.5 mm<sup>2</sup>, color: black, nominal current: 12 A, rated voltage (III/2): 320 V, contact surface: Tin, type of contact: Male connector, number of potentials: 10, number of rows: 1, number of positions: 10, number of connections: 10, product range: CCVA 2,5/..-G, pitch: 5.08 mm, mounting: THR soldering, pin layout: Linear pinning, solder pin [P]: 2.6 mm, number of solder pins per potential: 1, plug-in system: COMBICON MSTB 2,5, Pin connector pattern alignment: Standard, locking: without, mounting: without, type of packaging: packed in cardboard, For user information and design recommendations for through-hole reflow technology, go to: Downloads

## PCB header

PCB header - CCVA 2,5/10-G-5,08 P26THRR88 - 1956043

<https://www.phoenixcontact.com/pl/produkty/1956043>



PCB headers, nominal cross section: 2.5 mm<sup>2</sup>, color: black, nominal current: 12 A, rated voltage (III/2): 320 V, contact surface: Tin, type of contact: Male connector, number of potentials: 10, number of rows: 1, number of positions: 10, number of connections: 10, product range: CCVA 2,5/..-G, pitch: 5.08 mm, mounting: THR soldering, pin layout: Linear pinning, solder pin [P]: 2.6 mm, number of solder pins per potential: 1, plug-in system: COMBICON MSTB 2,5, Pin connector pattern alignment: Standard, locking: without, mounting: without, type of packaging: 88 mm wide tape, For user information and design recommendations for through-hole reflow technology, go to: Downloads

Phoenix Contact 2022 © - all rights reserved  
<https://www.phoenixcontact.com>

PHOENIX CONTACT Sp. z o.o.  
ul. Bierutowska 57-59, Budynek nr 3/A  
51-317 Wrocław  
71/ 39 80 410  
[pxcpl@phoenixcontact.pl](mailto:pxcpl@phoenixcontact.pl)