

PRODUCT NUMBER
SEE PART NO. TABLE

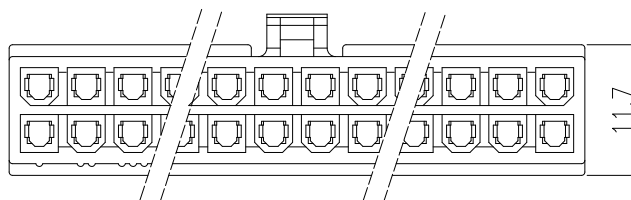
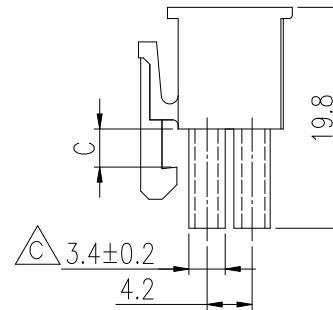
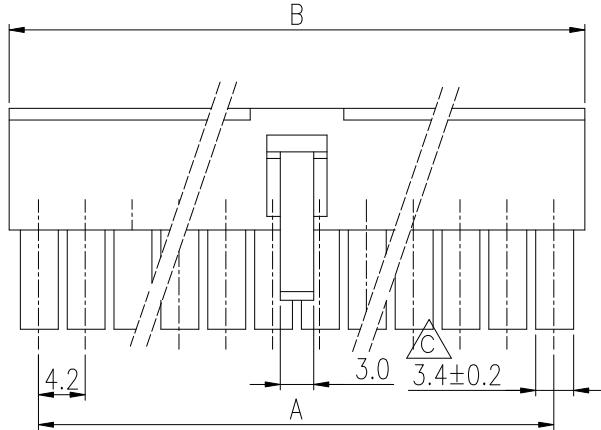
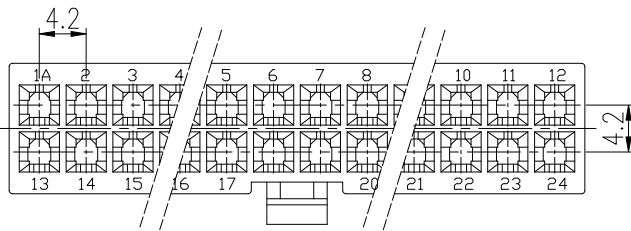
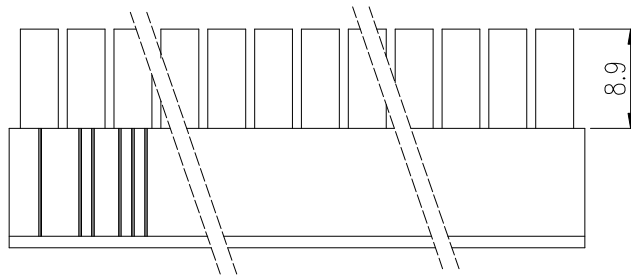

NOTES:

1. MATERIAL: NYLON 66, UL94V-0. GLOW WIRE COMPATIBLE
COLOR: NATURAL.
2. THIS HSG IS USED WITH FCI RECEPTACLE TERMINAL 10127817.
3. THIS RECEPTACLE MATES WITH FCI PLUG 10127816, 10127819 & 10127820.
4. PRODUCT SPECIFICATION: GS-12-1181.
5. PACKAGE SPECIFICATION: GS-14-2362.
6. PART NUMBER SCHEME:
10127815- XX LF

POS. CODE:

- 02: 2 POS.
- 04: 4 POS.
- 24: 24 POS.

7. DIMENSIONAL & PART NO. TABLE:

PART NUMBER	POS.	A	B	C
10127815-02LF	2		5.4	3.30
10127815-04LF	4	4.2	9.6	
10127815-06LF	6	8.4	13.8	
10127815-08LF	8	12.6	18.0	
10127815-10LF	10	16.8	22.2	3.60
10127815-12LF	12	21.0	26.4	
10127815-14LF	14	25.2	30.6	
10127815-16LF	16	29.4	34.8	
10127815-18LF	18	33.6	39.0	
10127815-20LF	20	37.8	43.2	
10127815-22LF	22	42.0	47.4	
10127815-24LF	24	46.2	51.6	

mat'l. code		surface		tolerance	projection	product family	
						MINITEK PWR4.2	
ltr	ecn no	dr	date	tolerances unless otherwise specified		title	
A		TAI	2013-11-11	X.X ±0.4		RECEPTACLE HSG, DUAL ROW	
B	ELX-T-19251	TAI	2014-10-31	X.XX ±0.3		MINITEK PWR4.2 WIRE CONNECTOR	
C	ELX-T-20468	TAI	2015-03-16	X*±1"		scale	
		dr	KENNY TAI	2013-11-11	dwg no		
		enr	KENNY TAI	2013-11-11	sheet 1 of 2		
		chr	KENNY TAI	2013-11-11	size		
		appd	PM ZHENG	2013-11-22	10127815		
sheet index		revision sheet	C 1	C 2	type		
					CUSTOMER Drawing		

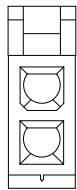

2 POS

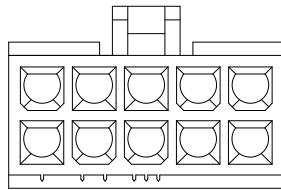

10 POS

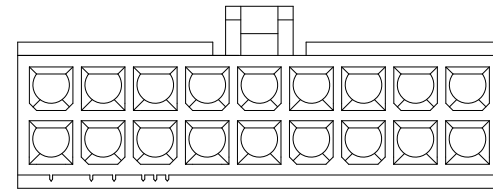

18 POS

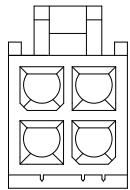

4 POS

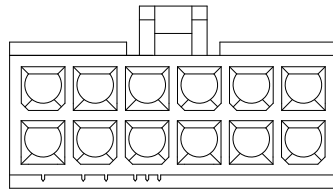

12 POS

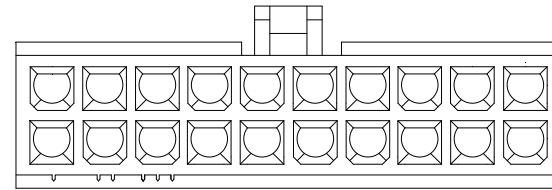

20 POS

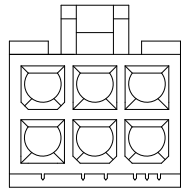

6 POS

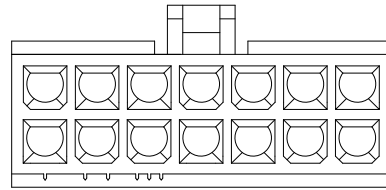

14 POS

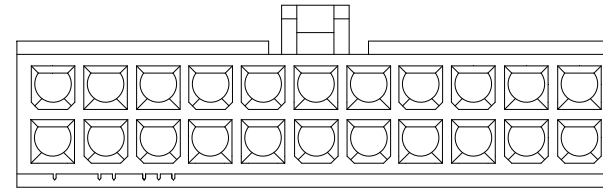

22 POS

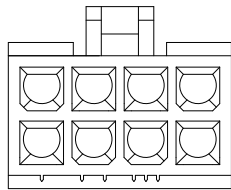

8 POS

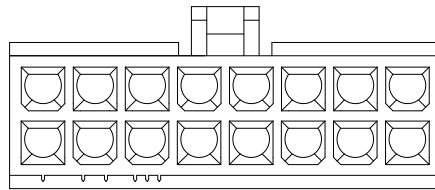

16 POS

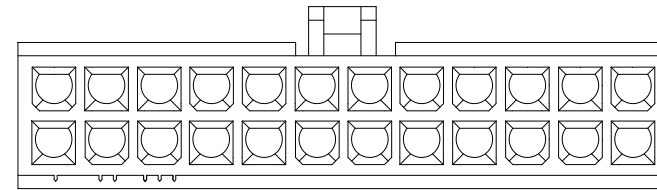

24 POS

mat'l. code				surface <input checked="" type="checkbox"/>		tolerance		projection		product family			
ltr				ecn no		dr		date		tolerances unless otherwise specified		MINITEK PWR4.2	
										title			
										RECEPTACLE HSG, DUAL ROW,			
										MINITEK PWR4.2 WIRE CONNECTOR			
										scale		scale	
										MM		scale	
										dr		KENNY TAI 2013-11-11	
										enr		KENNY TAI 2013-11-11	
										chr		KENNY TAI 2013-11-11	
										appd		PM ZHENG 2013-11-22	
sheet index				revision sheet		C 1		C 2		FCI logo		dwg no	
												sheet 2 of 2	
												size	
												A4	
												type	
												CUSTOMER Drawing	